



**CITY OF PHILOMATH
TRANSPORTATION SYSTEM PLAN
PHILOMATH, OREGON**

May 1999

Prepared for

**The City of Philomath
890 Applegate
Philomath, Oregon 97370**

and

**Oregon Department of Transportation
3700 SW Philomath Boulevard
Corvallis, Oregon 97333**

Prepared by

**Cogan Owens Cogan
813 SW Alder Street
Portland, Oregon 97205**

and

**David Evans and Associates, Inc.
2828 SW Corbett Avenue
Portland, Oregon 97201**

**TRANSPORTATION AND TRAFFIC
SAFETY COMMISSION**

**Dale Collins
Susan Craig-Aschoff
Mike Crocker
May Dasch
Bob Gay
Ray Hickman
Toni Hoyman
Marilyn Slizeski**

**CITY OF PHILOMATH TRANSPORTATION PLAN
TECHNICAL ADVISORY COMMITTEE**

**John Evans
Peter Idema
Roger Irvin
Randy Kugler
Jim Owens
Nancy Reynolds
Beau Vencill**

TABLE OF CONTENTS

	Page
EXECUTIVE SUMMARY	1
INTRODUCTION.....	3
CHAPTER 1: PLANS AND STUDIES	5
REVIEW OF EXISTING PLANS, POLICIES, AND STUDIES.....	5
Oregon Transportation Plan.....	5
The Oregon Highway Plan.....	5
Draft 1998-2001 State Transportation Improvement Program.....	5
Draft US 20 OR 34 Interim Corridor Strategy.....	5
Benton County Transportation System Plan.....	6
Corvallis Transit Master Plan	6
West Corvallis-North Philomath Plan (1996).....	7
Newton Creek-Neer Street, Highway 20/34 Corvallis-Newport Highway Environmental Assessment.....	7
Highway 20/34 Committee Report to the Philomath City Council.....	7
June 3, 1994 Memorandum from Van Hunsaker, Mayor of Philomath, to Philomath City Council Regarding Philomath Downtown Highway Project.....	7
City of Philomath Ordinance No. 615 - An Ordinance Amending the Economic and Transportation Elements of the Comprehensive Plan and the Plan Transportation Map.....	8
July 18, 1994 Memorandum from Mayor Van Hunsaker to ODOT Regarding Highway 20/34 Main Street Improvements	8
Transportation Element - Philomath Comprehensive Plan 1993.....	8
City of Philomath Subdivision Ordinance No. 622	8
Master Philomath Bike Path and Trails Plan 1994.....	9
Philomath Ordinance No. 608 - Sidewalks.....	9
Philomath Land Use Map	9
Population and Employment Projections.....	9
Transportation Disadvantaged	9
Industrial Wetlands.....	10
CHAPTER 2: GOALS AND OBJECTIVES	11
GOAL 1: Relieve Increasing Traffic Congestion on Highway 20/34.....	11
GOAL 2: Improve Traffic Circulation and Safety Throughout the City.....	11
GOAL 3: Promote the Increased Use of Alternative Modes.....	12
GOAL 4: Develop a Master Plan that Defines Future Street Locations.....	12
GOAL 5: Provide Alternate Routes to Deter Through Industrial Traffic out of the Downtown Core and Residential Neighborhoods.....	12
GOAL 6: Integrate the Transportation System Plan with Other Land Use Planning Projects in the City.....	13
PUBLIC INVOLVEMENT SUMMARY REPORT	13
Summary.....	13
Introduction.....	13
Key Issues	14
OPEN HOUSE PROGRAM.....	15
Proposed Couplet.....	16
Site-Specific Needs and Improvements.....	16
Responses to Miscellaneous Questions	16

TABLE OF CONTENTS

	Page
Future Public Involvement Opportunities.....	18
Effectiveness of the Open House.....	18
Summary Of Second Open House	19
Key Improvements And Alternatives	20
Responses to Improvement Options	20
CHAPTER 3: TRANSPORTATION SYSTEM INVENTORY.....	33
STREET SYSTEM.....	33
State Highways	33
STREET CLASSIFICATION.....	34
Arterial Streets	34
Collector Streets.....	34
Local Streets.....	35
STREET LAYOUT	35
ROADWAY SAFETY.....	35
Summary	36
Pedestrian Accidents.....	36
Historic Accident Rates	36
Accident Locations (ODOT Records).....	36
Main Street (US Highway 20) and 19th Street.....	37
Main Street (US Highway 20) and 21st Street.....	37
Main Street (US Highway 20) and Newton Street.....	38
Applegate Street and 13th Street.....	38
Philomath Police Department Traffic Crash Locations.....	39
Applegate Street and 19th Street.....	39
Main Street and 13th Street.....	39
Main Street and 24th Street.....	39
GENERAL PAVEMENT CONDITIONS.....	39
State Highways	41
Collectors	41
Other Roadways.....	41
BRIDGES.....	41
BICYCLE FACILITIES.....	42
PEDESTRIAN FACILITIES	42
TRANSIT SERVICE	43
RAIL SERVICE	43
AIR SERVICE.....	43
WATERBORNE TRANSPORTATION.....	43
PIPELINES.....	43
CHAPTER 4: CURRENT TRAFFIC CONDITIONS.....	45
TRAFFIC VOLUMES.....	45
Average Daily Traffic.....	45
Hourly Traffic Patterns	45
Weekday PM Peak Hour Volumes	46
TRAFFIC OPERATIONS.....	47
Roadway Capacity	47

TABLE OF CONTENTS

	Page
Roadway Operations.....	47
Intersection Operations.....	48
Signalized Intersections.....	48
Unsignalized Intersections.....	49
EXISTING SIGNAL WARRANTS.....	49
EXISTING TRUCK ROUTES AND TRAFFIC	50
CHAPTER 5: TRAVEL FORECASTS.....	53
DEFINITION.....	53
TRAFFIC MODEL	53
FUTURE TRAFFIC FORECASTS.....	53
NO-BUILD SCENARIO.....	54
Traffic Volumes.....	54
Changes in Traffic Patterns.....	54
Future Traffic Operations	54
Streets.....	54
Intersections.....	55
CHAPTER 6: EVALUATION OF TRANSPORTATION SYSTEM IMPROVEMENT OPTIONS.....	57
EVALUATION CRITERIA	57
EVALUATION OF POTENTIAL TRANSPORTATION IMPROVEMENT OPTIONS.....	58
Land Use Strategy - Revise Zoning and Development Codes.....	58
Transportation Demand Management Strategy.....	58
Transportation System Management Options.....	59
Major Street Improvement Options.....	60
Evaluation TSM and Major Street Improvement Options.....	64
Bicycle Improvement Options.....	89
Bicycle Improvements Associated with Identified New Roadway Projects.....	89
Bicycle Improvements Not Associated with Identified New Roadway Projects.....	90
Pedestrian Improvement Options.....	95
Transit.....	96
Rail.....	97
Air, Water, and Pipeline.....	97
CHAPTER 7: TRANSPORTATION SYSTEM PLAN	99
STREET FUNCTION CLASSIFICATION AND DESIGN STANDARDS	99
Street System Functional Classification.....	99
Existing Street Standards.....	100
Recommended Street Standards	101
Street Sections.....	103
ACCESS MANAGEMENT	104
Access Management Techniques.....	104
Recommended Access Management Standards.....	105
Application.....	106
State Highways	106
MODAL PLANS.....	108
Street System Plan	108

TABLE OF CONTENTS

	Page
Truck Routing	108
Street Improvement Projects.....	109
Statewide Transportation Improvement Program (STIP) Projects.....	110
Pedestrian System Plan.....	110
Curb Extensions.....	112
Raised Medians.....	113
Bicycle System Plan.....	113
Transportation Demand Management Plan.....	115
Public Transportation Plan.....	115
Rail Service Plan.....	116
Air Service Plan.....	116
Pipeline Service Plan	117
Water Transportation Plan.....	117
TRANSPORTATION SYSTEM PLAN IMPLEMENTATION PROGRAM.....	117
CHAPTER 8: FUNDING OPTIONS AND FINANCIAL PLAN.....	119
HISTORICAL STREET IMPROVEMENT FUNDING SOURCES.....	119
Transportation Funding in Benton County.....	120
Historical Revenues and Expenditures in the City of Philomath.....	121
Transportation Revenue Outlook in the City of Philomath.....	122
REVENUE SOURCES.....	124
Property Taxes	124
System Development Charges.....	125
State Highway Fund.....	125
Local Gas Taxes.....	126
Vehicle Registration Fees.....	126
Local Improvement Districts.....	126
GRANTS AND LOANS.....	126
Bike-Pedestrian Grants.....	127
Enhancement Program.....	127
Highway Bridge Rehabilitation or Replacement Program.....	127
Transportation Safety Grant Program.....	127
Special Transportation Fund.....	128
Special Small City Allotment Program.....	128
Immediate Opportunity Grant Program.....	128
Oregon Special Public Works Fund.....	128
Oregon Transportation Infrastructure Bank.....	129
ODOT FUNDING OPTIONS.....	129
Financing Tools	130
General Obligation Bonds.....	130
Limited Tax Bonds.....	130
Bancroft Bonds	130
FUNDING REQUIREMENTS.....	131

TABLE OF CONTENTS

APPENDICES

- Appendix A: Planning and Performance Guidelines
- Appendix B: Master Philomath Bike Path and Trail Plan
- Appendix C: Potential Issues to be Addressed in the TSP
Comments Regarding Potential Issues to be Addressed in the TSP
Site-Specific Improvements and Needs Open House and Questionnaire Responses
- Appendix D: 1997 Major Street Inventory
- Appendix E: Hourly Link Capacities Used in Traffic Model Plots
Description of Level of Service Methodology
Signal Warrant Analysis
Details of Operations Analysis at Intersections
- Appendix F: Pedestrian Improvement Strategies
- Appendix G: Grant and Loan Contacts 1998

LIST OF TABLES

Page

2-1: ISSUES TO BE ADDRESSED IN THE PHILOMATH TSP NEWSLETTER RESPONDENTS	14
2-2. ISSUES TO BE ADDRESSED IN THE PHILOMATH TSP OPEN HOUSE RESPONDENTS.....	15
2-3. TABULATION OF SURVEY RESPONSES.....	18
2-4. OPEN HOUSE EFFECTIVENESS	19
2-5. COUPLET QUESTIONNAIRE RESPONSES	21
2-6. LOCAL STREET IMPROVEMENT OPTIONS QUESTIONNAIRE RESPONSES	22
2-7. CLEMENS MILL ROAD QUESTIONNAIRE RESPONSES.....	24
2-8. TRAFFIC SIGNAL QUESTIONNAIRE RESPONSES	25
2-9. TRUCK ROUTE IMPROVEMENTS QUESTIONNAIRE RESPONSES	26
2-10. CONSTRUCT NEW ROADS QUESTIONNAIRE RESPONSES	27
2-11. ADDITIONAL BICYCLE LANES QUESTIONNAIRE RESPONSES.....	29
2-12. PEDESTRIAN PATHS QUESTIONNAIRE RESPONSES	30
3-1. PHILOMATH ACCIDENT SUMMARY	36
3-2. HISTORIC ACCIDENT RATES FOR STATE HIGHWAYS IN PHILOMATH	36
3-3. HIGH ACCIDENT LOCATION SUMMARY	37
4-1. CURRENT LEVEL OF SERVICE AND SATURATION VALUES (X) AT SELECTED SIGNALIZED INTERSECTION	49
4-2. CURRENT LEVEL OF SERVICE AT SELECTED UNSIGNALIZED INTERSECTIONS	49
4-3. SIGNAL WARRANT ANALYSIS AT SELECTED UNSIGNALIZED INTERSECTIONS.....	50
5-1. YEAR 2016 NO BUILD LEVEL OF SERVICE AND SATURATION VALUES.....	55
5-2. 2016 NO-BUILD LEVEL OF SERVICE AT SELECTED UNSIGNALIZED INTERSECTIONS.....	56
6-1. MAJOR HIGHWAY IMPROVEMENT ALTERNATIVES	61
6-2. SUMMARIZED RECOMMENDATIONS FOR ALL PROJECT IMPROVEMENT OPTIONS	62
6-3. ESTIMATED COSTS FOR COLLEGE/MAIL/APPLEGATE ONE-WAY COUPLET.....	75
6-4. ESTIMATED COSTS FOR APPLEGATE/MAIN ONE-WAY COUPLET	77
6-5. ESTIMATED COSTS FOR ONE-WAY COUPLET 11A WITH ADDITIONAL CAPACITY IMPROVEMENTS.....	79
6-6. ESTIMATED COSTS FOR EXTENDED ONE-WAY COUPLET.....	80
6-7. ESTIMATED COSTS TO WIDEN HIGHWAY 20/34 TO FIVE LANES IN PHILOMATH.....	82
6-8. COSTS FOR THE WEST HILLS ROAD EXTENSION.....	84
6-9. ESTIMATED COSTS FOR WIDENING 9TH STREET/WEST HILLS ROAD FOR BIKE LANES	94
7-1. RIGHT-OF-WAY AND ROADWAY WIDTH STANDARDS	100
7-2. RECOMMENDED STREET STANDARDS FOR STATE HIGHWAYS, COUNTY ROADS AND LOCAL STREETS.....	102
7-3. RECOMMENDED RIGHT-OF-WAY ROADWAY WIDTH STANDARDS	104
7-4. RECOMMENDED ACCESS MANAGEMENT GUIDELINES.....	105
7-5. OPTIMUM SIGNALIZED INTERSECTION SPACING FOR EFFICIENT TRAFFIC PROGRESSION	108
7-6. RECOMMENDED STREET PROJECTS	109
7-7. RECOMMENDED PEDESTRIAN IMPROVEMENT PROJECTS.....	111
7-8. RECOMMENDED BICYCLE PROJECTS	114
7-9. RECOMMENDED RAILROAD SYSTEM PROJECTS.....	116
7-10. RECOMMENDED TRANSPORTATION IMPROVEMENT PROJECTS LIST	118

LIST OF TABLES

	Page
8-1. SOURCES OF ROAD REVENUES BY JURISDICTION LEVEL	119
8-2. BENTON COUNTY TRANSPORTATION RELATED REVENUES	120
8-3. BENTON COUNTY TRANSPORTATION RELATED EXPENDITURES	121
8-4. CITY OF PHILOMATH STREET FUND REVENUES	121
8-5. CITY OF PHILOMATH STREET FUND EXPENDITURES.....	122
8-6. ESTIMATED RESOURCES AVAILABLE TO CITY OF PHILOMATH FROM STATE HIGHWAY FUND	123
8-7. RECOMMENDED TRANSPORTATION IMPROVEMENT PROJECTS LIST	132
8-8. ESTIMATED CAPITAL FUNDING BALANCE	133

LIST OF FIGURES

Follows Page

1. PHILOMATH STUDY AREA	4
1-1. LAND USE AND ZONING MAP	10
1-2. WETLANDS DISTRIBUTION MAP	10
3-1. EXISTING STREET CLASSIFICATIONS AND TRAFFIC SIGNALS	34
3-2. EXISTING BICYCLE FACILITIES.....	42
4-1. 1996 ADT VOLUMES.....	46
4-2. HOURLY TRAFFIC PATTERNS	46
4-3. 1996 PM PEAK HOUR TRAFFIC VOLUMES	46
4-4. EXISTING TRUCK ROUTE SYSTEM & TRUCK VOLUMES	51
5-1. 2016 NO-BUILD PM PEAK HOUR TRAFFIC VOLUMES	54
5-2. 2016 AVERAGE DIALY TRAFFIC VOLUMES	54
6-1. TSM IMPROVEMENT OPTION	60
6-2. MAJOR STREET IMPROVEMENT OPTIONS - HIGHWAY 20/34	60
6-3. MAJOR NEW STREET CONSTRUCTION OPTIONS.....	60
6-4. POTENTIAL BICYCLE AND PEDESTRIAN FACILITIES	89
7-1. FUTURE STREET CLASSIFICATION AND TRAFFIC SIGNALS	100
7-2. STREET STANDARDS.....	103
7-3. STREET STANDARDS.....	103
7-4. PROPOSED TRUCK ROUTE SYSTEM	109
7-5. RECOMMENDED STREET AND INTERSECTION IMPROVEMENT PROJECTS	109
7-6. RECOMMENDED BICYCLE AND PEDESTRIAN IMPROVEMENT PROJECTS	111
7-7: CURB EXTENSIONS REDUCE CROSSING DISTANCE.....	112
7-8: MID-BLOCK CURB EXTENSION WITH MEDIAN AND ILLUMINATION	113
8-1. STATE HIGHWAY FUND.....	122

EXECUTIVE SUMMARY

This Philomath Transportation Systems Plan (TSP) contains a 20-year transportation systems plan for the Philomath area. It contains plans for the different transportation modes in Philomath to meet state planning requirements in the Oregon Transportation Planning Rule.

The review of existing plans identified several issues to be addressed in this plan including determining the future population (transportation demands), a future street network and the future footprint for US 20/OR 34 (wider two-way streets, a bypass or one-way couplet) through downtown Philomath. As part of the public involvement process there were six goals with a number of objectives established for the TSP. The six goals are as follows:

1. Relieve increasing traffic congestion on US 20/OR 34.
2. Improve traffic circulation and safety throughout the city.
3. Promote increased use of alternative modes.
4. Develop a master plan that defines future street locations.
5. Provide alternate routes to deter truck traffic in the downtown core and residential neighborhoods.
6. Integrate this transportation system plan with other land use planning projects in Philomath.

The transportation system inventory included information on all of the transportation systems and revealed several needs that resulted in project recommendations as part of this plan, such as the recommended street overlays, bicycle lanes and the improved street name signing. It was also found that trucks are limited to certain routes due to weight limits on several streets. The current and forecast traffic analysis showed that transportation operations will be at levels below acceptable criteria in the future without needed transportation improvements on US 20/OR 34 (Highway 20/34). Without major transportation system improvements (No Build), delays on Highway 20/34 would be expected to be long with stop and go traffic during the p.m. peak hours. Some of the local streets such as North 9th, College, Applegate and Chapel Streets would be expected to have large increases in traffic.

In addition to the No Build scenario a number of transportation system improvement options were evaluated. As a result of the public input and the analysis performed, a phased one-way couplet project was recommended as part of the 20 Year plan for Philomath. The first phase of this project would make improvements to College and Applegate Streets, maintaining two-way traffic on all the streets until the second phase is needed and constructed using Main, Applegate and College Streets. As part of the analysis a West Hills Road connection to Highway 20 at the Alsea Highway 34 was evaluated. It was found that this project would not attract enough traffic to bypass the downtown area to meet future travel demands on Highway 20/34. However it was also found that this connection would likely be needed soon after the 20-year period for this TSP.

In addition to the improvements in the TSP, there are future street and bicycle network maps. Future truck routes are also included in the plan. Narrower street standards for local streets are also proposed as part of the TSP. In addition pedestrian and rail improvements are included. A number of the bicycle and pedestrian improvements are proposed as part of other street improvement projects.

Most of the needed improvements to major streets over the next 20 years are on the state and Benton County road systems. Transportation funding is expected to be a major concern for these projects, as well as for the projects, which are on the city of Philomath transportation system. This conclusion is based on the current and expected transportation system funding in Philomath which was compared to the recommended transportation system plan projects estimated costs.

Improvements to all of the modes of transportation are needed to make the Philomath system work at acceptable levels in the future. The transportation system in Philomath is discussed in detail as part of this study.

INTRODUCTION

The City of Philomath Transportation System Plan (TSP) was prepared to guide the development of the transportation facilities in Philomath over the next 20 years. It covers forecasted transportation needs and expected improvements in the Philomath area for the next 20 years. This TSP serves as the transportation element of the City's comprehensive plan to satisfy the state planning requirements in the Oregon Transportation Planning Rule (TPR).

The TSP focuses on the area inside the Philomath Urban Growth Boundary (UGB) shown in Figure 1. The easterly Philomath UGB boundary is west of the city of Corvallis; however it is expected that all of the Philomath area inside it's UGB will be covered by a Metropolitan Planning Organization for both Corvallis and Philomath when the combined population exceeds 50,000 after the year 2000.

For the most part the Philomath area consists of relatively flat topography with the exception of the hills in the northwest and southeastern parts of the city. Newton Creek traverses in the middle of the area in a southeast direction and Mary's River abuts the southwest UGB. The transportation system includes two highways, US 20 (Highway 20) and OR 34 (Highway 34). These two highway routes are coincident in an east/west direction with Highway 34 splitting off from Highway 20 at the southwest UGB. Highway 20 is a major east/west route to the coast and Highway 34 also serves as a more local route to the coast. In addition there are a number of collector roads in the area that serve mostly local Corvallis/Philomath area traffic. Most of these collector roads are also Benton County roads in the city of Philomath. In addition to the Benton County roads inside the UGB, three roads outside the UGB were discussed. Two of these roads are the proposed Bellfountain Road extension and the Grange Hall Road/Fern Road (13th Street) route. A short portion of a proposed West Hills Road connection to Highway 34 is also outside the UGB. These three routes have impacts on transportation in the Philomath area and were of interest to the community involvement participants.

This Transportation System Plan is the result of approximately one-year's effort beginning in 1998 through early 1999. Input and direction for the plan development was provided by a Transportation Advisory Committee (TAC) and the Philomath Transportation and Traffic Safety Commission (TTSC). The TAC included staff from the City of Philomath, ODOT, Cascades West Council of Governments and Benton County. The TTSC included representatives from city government as well as citizen representatives. A list of the TAC/TTSC members is included inside the front cover. These two advisory groups met approximately every other month throughout the planning process. In addition there were also two community open house/workshop sessions and newsletters with response forms to obtain public comments. The combination of the TAC/TTSC and public input represents the community involvement, which was vital to the development of this TSP.

At the start of the planning process, existing applicable plans and studies were reviewed, existing transportation infrastructure conditions were collected and inventoried, and goals and objectives for the project were developed. The review of existing plans and studies is summarized in Chapter 1. These plans were the basis for the existing land use and were intended to provide guidance for future transportation facilities in Philomath. Chapter 2 lists the goals and objectives for this Transportation System Plan and discusses the community involvement process. Chapter 3 and Appendix D contain the existing condition inventory information for the transportation systems in Philomath. Chapter 4 includes data and a description of the current traffic conditions and transportation operations in the Philomath area. Chapter 5 discusses the traffic forecasts and analysis for the year 2016 with the existing transportation system and no improvements (No Build). Input from the community involvement process and the

results from Chapter 5 were used to develop a set of potential transportation improvements (Options) described in Chapter 6. Each of the improvement options was analyzed based on future traffic with a recommendation made in Chapter 6. Chapter 7 contains the transportation system 20 year plan with the lists of recommended transportation projects for the Philomath urban area. The existing and expected future transportation funding for Philomath is discussed and compared with the needed transportation projects in Chapter 8.

The recommended implementation ordinances are included in a separate appendix document prepared and provided by the Cascades West Council of Governments.



(NOT TO SCALE)

LEGEND:

- URBAN GROWTH BOUNDARY
- CITY LIMITS

FIGURE 1



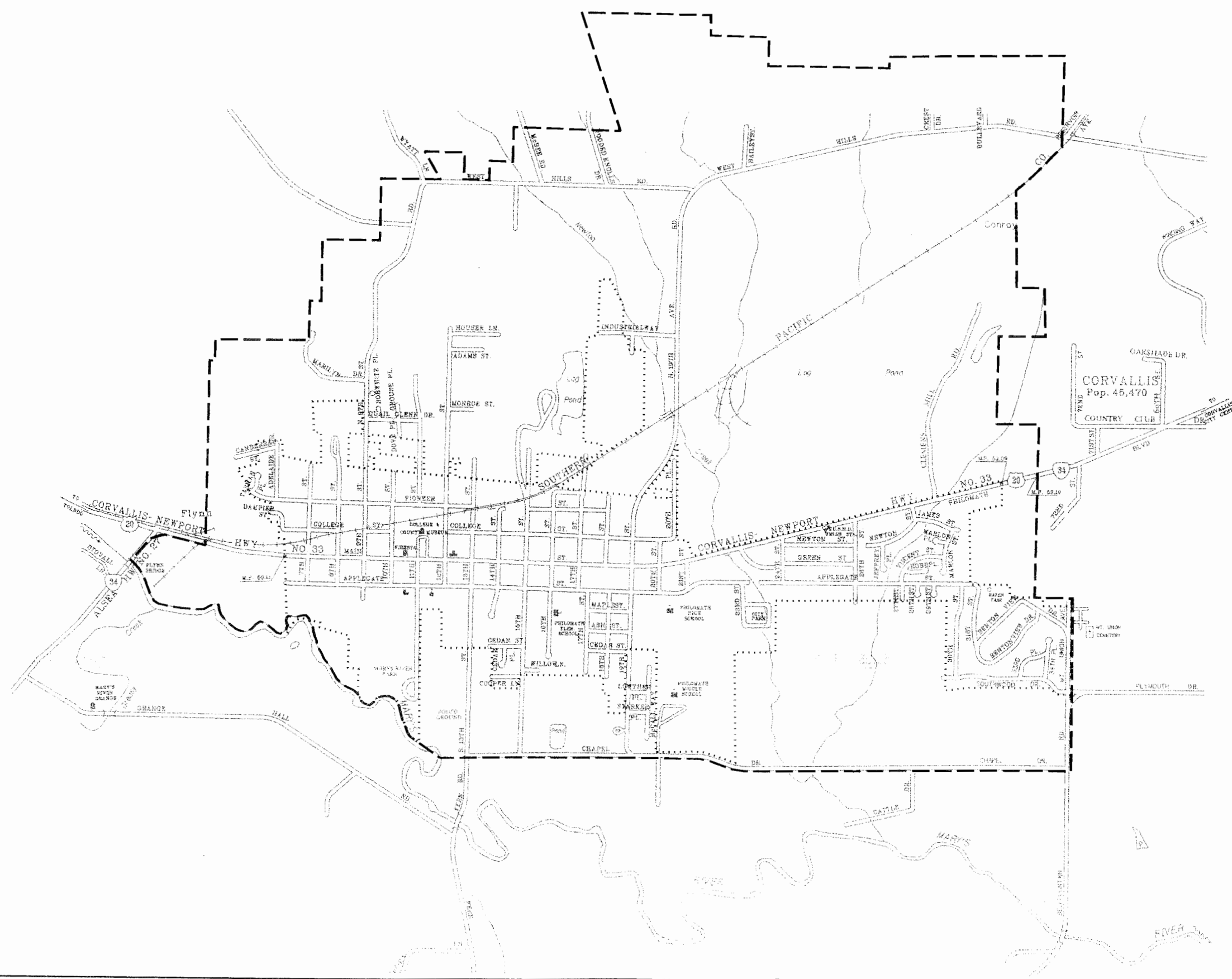

Philomath Study Area

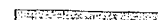
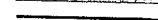

ODOT0254/FIG1-I.DGN/BJD/07-08-98

CITY OF
PHILOMATH
 OREGON
 ZONING

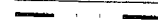
LEGEND

-  PROPOSED RESOLUTION AREA
-  URBAN GROWTH BOUNDARY
-  City Limits
-  Zoning District Boundaries
-  BC Zoning District Boundaries

CITY ZONING DISTRICTS		Benton County Zoning Districts	
C-1	Downtown Commercial	I(IP)	Industrial
C-2	General Commercial	I(HI)	Heavy Industrial
C-3	Highway Commercial	I(LI)	Light Industrial
C-4	Planned Commercial	UR-5(MDR)	Urban Residential
R-1	Low Density Residential	UR-5(LDR)	Urban Residential
R-2	Medium Density Residential	UR-5(HDR)	Urban Residential
R-3	High Density Residential	C(C)	Commercial
O	Office	C(C-2)	Commercial
P	Public		
O/R	Office/Residential		
LI	Light Industrial		
HI	Heavy Industrial		
SPD	Special Planned Development		

Map based on Tax Assessment Maps of Benton, Co., Oregon. Map Updated Nov., 1995

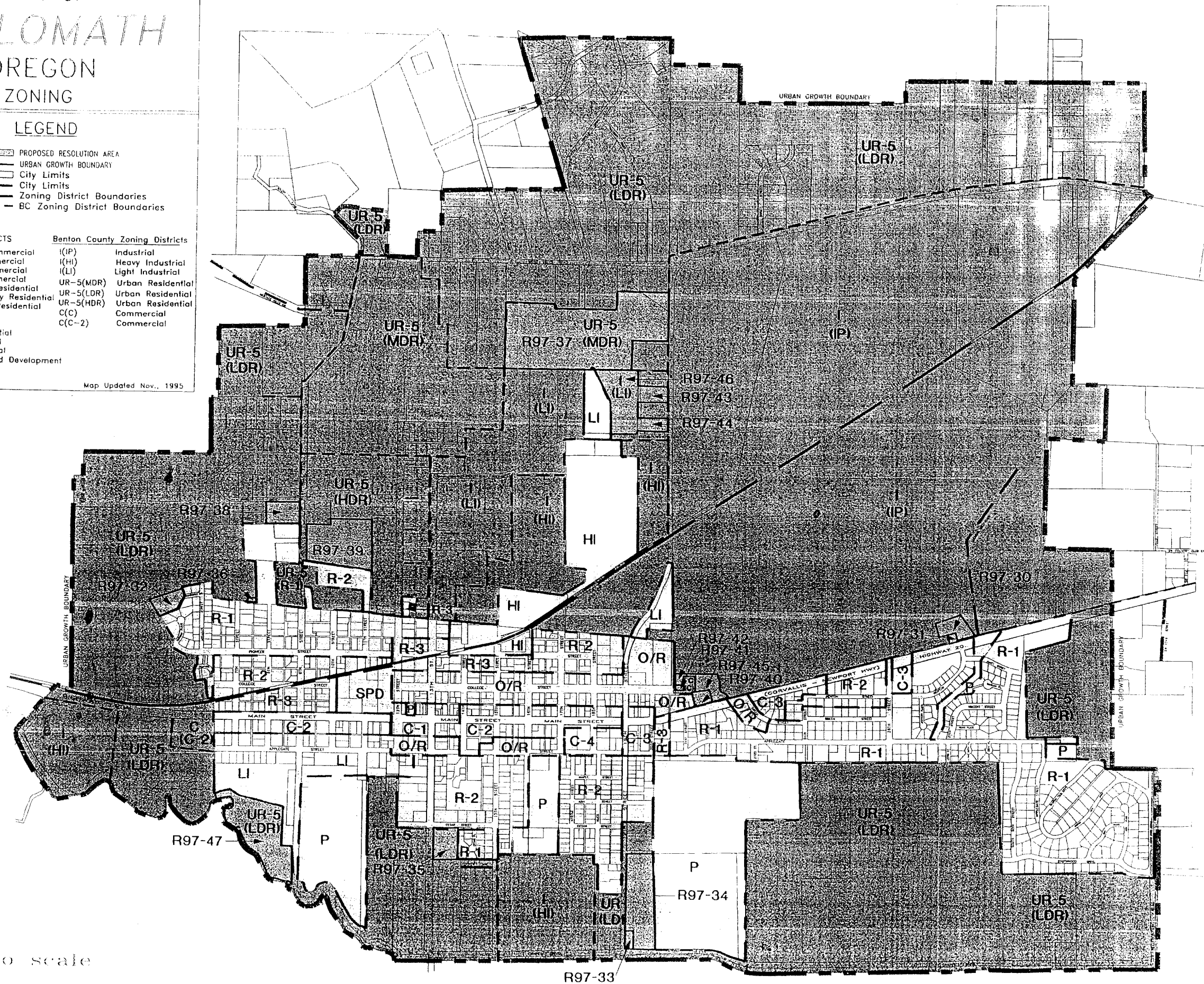

Not to scale

Figure 1-1

CITY OF PHILOMATH, OREGON
Wetlands Distribution Map*

- Urban Growth Boundary
- ⋯ Wetland, No / Low Enhancement Potential
- ⋯ Wetland, Moderate / High Enhancement Potential
- == IWS Alternatives

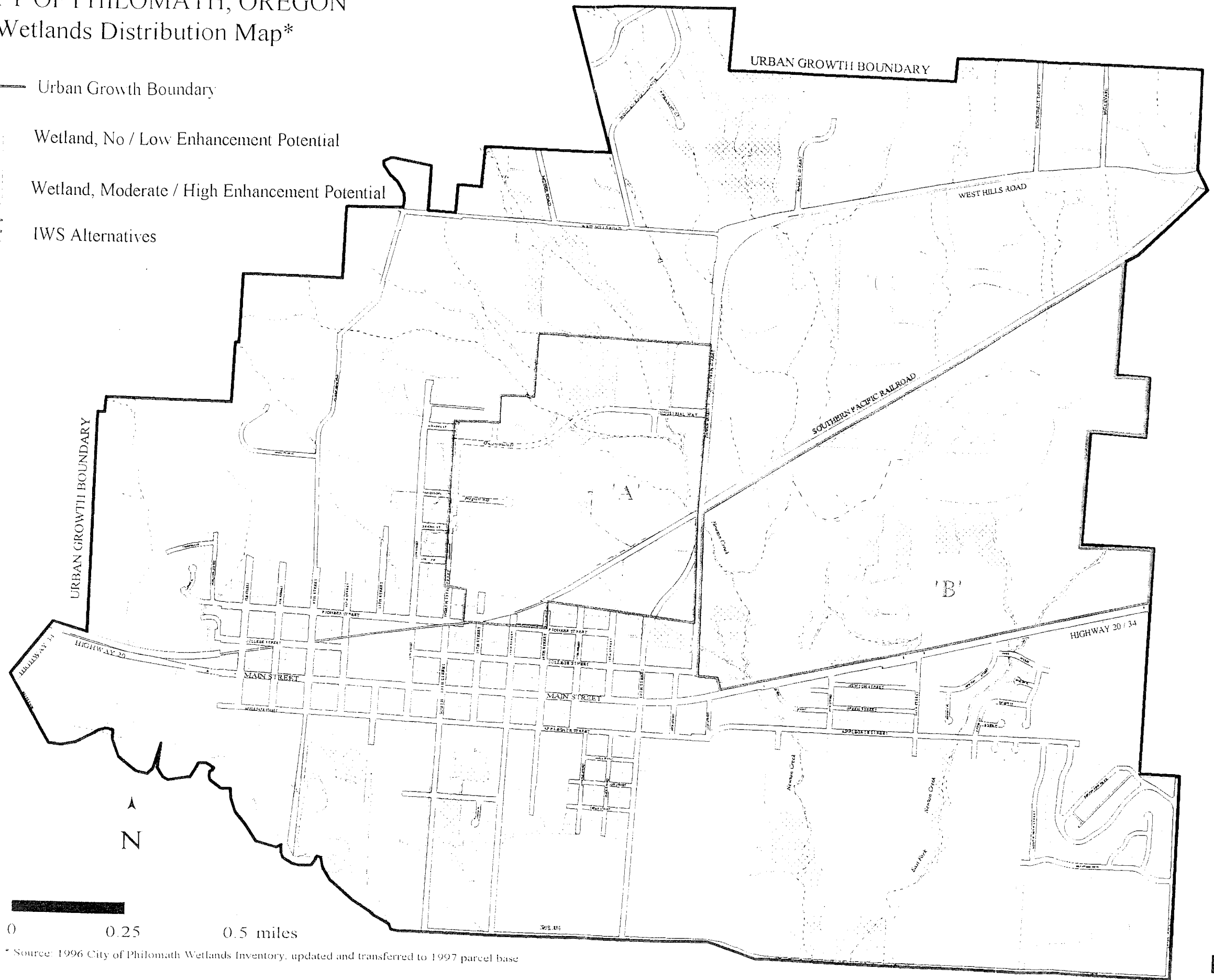

* Source: 1996 City of Philomath Wetlands Inventory, updated and transferred to 1997 parcel base

Figure 1-2

CHAPTER 2: GOALS AND OBJECTIVES

The following goals and objectives were developed based on other previous plans including the City of Philomath Comprehensive Plan. Input was provided based on transportation needs identified from the first public open house and guidance was provided from the TAC/TTSC to develop these goals and objectives. These goals and objectives were developed by the community to provide direction for the development of this plan and for continuity with other current plans transportation plans.

GOAL 1: Relieve Increasing Traffic Congestion on Highway 20/34

Objectives

- Evaluate traffic counts, growth projections, and land use patterns to determine whether Highway 20/34 should be further improved within the Philomath Urban Growth Boundary (UGB).
- Consider alternatives to widening Highway 20/34, including transportation demand management measures that could reduce peak hour demand.
- Analyze the impacts of signalized and unsignalized intersections and rights-of-way in increasing the capacity of Highway 20/34 (e.g., better synchronization of signals, updated/additional traffic controls, etc.).
- Utilize access management measures, including limiting additional access points on Highway 20/34 and restricting existing access to manage access to local properties while preserving traffic flow.

GOAL 2: Improve Traffic Circulation and Safety Throughout the City

Objectives

- Evaluate transportation and parking improvements to downtown traffic flow, including a one-way couplet on College and Main Streets.
- Examine the role and potential of local street connections (e.g., how they are tied to Highway 20/34 and the impacts of couplet connections).
- Improve pedestrian/bicycle access across Highway 20/34, especially to schools, parks, and public buildings.
- Improve cross-town (both north-south and east-west) circulation and connectivity.
- Ensure that the street designs, especially couplets, avoid separation of the community.
- Evaluate the impacts of a bridge over Newton Creek to extend Applegate Street.
- Assess options to reduce traffic volumes and speeds near schools.
- Review design standards for streets.

GOAL 3: Promote the Increased Use of Alternative Modes

Objectives

- Identify measures to improve circulation for alternative modes.
- Improve pedestrian circulation within and between neighborhoods and commercial centers.
- Ensure connections to the existing pedestrian system (i.e., sidewalks and crosswalks) with new developments.
- Identify intersection improvements that enhance pedestrian safety.
- Provide additional sidewalks and improve existing sidewalks to enhance pedestrian safety and access.
- Identify measures (e.g., fixed-route bus systems, dial-a-ride, park-and-ride, vanpool, etc.) to develop and maintain transit usage.
- Assess potential of the railroad system for commuter rail, commercial rail, and excursion uses.
- Identify potential park-and-ride locations at both the east and west ends of the city.

GOAL 4: Develop a Master Plan that Defines Future Street Locations

Objectives

- Identify future street locations, especially in North Philomath and the Newton Creek industrial area.
- Develop street classifications and access management standards for existing and future street locations.
- Consider the *West Corvallis-North Philomath Plan* guidelines for an integrated circulation network for that area.

GOAL 5: Provide Alternate Routes to Deter Through Industrial Traffic out of the Downtown Core and Residential Neighborhoods

Objectives

- Develop a truck routing plan that minimizes/avoids conflicts with schools, residential areas, and the downtown core.
- Investigate alternate truck routes (e.g., Grange Hall Road) or other roads outside the city core.

GOAL 6: Integrate the Transportation System Plan with Other Land Use Planning Projects in the City

Objectives

- Review the comprehensive plan and other applicable plans to ensure compatibility.
- Develop a plan that is compatible with other land use plans.

PUBLIC INVOLVEMENT SUMMARY REPORT

Summary

As a first step in preparation of the Philomath TSP, public input on transportation system needs and issues was solicited through a newsletter/questionnaire directly mailed to each household in Philomath and a public open house held on March 31, 1998. A number of key issues for study in the development of the TSP were identified and ranked by respondents to the questionnaire and participants in the open house.

Among the key issues to be addressed in the TSP are:

- Improvements in overall traffic circulation within and through the city;
- Couplet connections, with strong support expressed for the alignment specified in the city's comprehensive plan (College and Main Streets between 12th and Newton Creek and Main and Applegate Streets from 14th to the Highway 20/34 intersection);
- Improvements to pedestrian access across Main Street and to the downtown commercial area; and
- Neighborhood traffic issues, e.g., dangerous intersections, speeding, etc.

The most frequently mentioned site-specific improvements to be assessed in the TSP process include:

- Connecting Applegate with a bridge over Newton Creek;
- Access to Highway 20/34 at Clemens Mill Road;
- Improving the 19th and Main Street intersection for trucks; and
- Alternate routes (e.g., Chapel Drive or a bypass) for trucks and other through traffic around downtown Philomath.

Introduction

Public input on issues to be addressed and the scope of TSP analysis was solicited through three mechanisms:

- Direct-Mail Newsletter Questionnaires: A newsletter on TSP and other related studies was mailed in March 1998 to all city residents. This newsletter contained a mail-back questionnaire and announcement of the TSP open house.
- Public Open House: Held March 31, 1998, in the Philomath High School Library, the open house was publicized through the direct mail newsletter and in the *Benton Bulletin*, and the *Corvallis Gazette Times*.

- **Open House Questionnaire:** Essentially the same as the newsletter questionnaire, this questionnaire was distributed to participants at the open house who had not completed the newsletter questionnaire. An additional section asked respondents to rate the effectiveness of the open house.

Key Issues

The project's Technical Advisory Committee (TAC) and the Traffic and Transportation Safety Commission (TTSC) generated a list of preliminary issues to be assessed in the TSP. In both the direct-mail newsletter questionnaire and in the open house survey, respondents were asked to rate a list of 13 potential issues to be addressed in the TSP. Key issues identified from the newsletter questionnaires include improvements in overall traffic circulation, couplet connections, design of couplet to avoid separation of the community, improvements to pedestrian access across Main Street and through downtown, and separation of truck traffic through downtown. A weighted ranking of responses is shown in the table below. A detailed tabulation of responses can be found in Appendix C.

**TABLE 2-1
ISSUES TO BE ADDRESSED IN THE PHILOMATH
TSP NEWSLETTER RESPONDENTS¹**

Issue	Weighted Rank
Improvements in overall traffic circulation	1
Couplet connections	2
Design of couplet to avoid separating the community	3 ²
Improvements to pedestrian access across Main Street and in the downtown commercial area	4
Separation of truck traffic through downtown	5
Control of access points to Highway 20/34	6
Neighborhood traffic issues, e.g., dangerous intersections, speeding, etc.	7
Additional or improved arterial or collector streets to accommodate future growth	8
Parking	9
Improved/new bicycle facilities	10
Bypass around Philomath	11
Design standards for residential streets	12
Access improvements to the Newton Creek industrial area	13

¹Number of responses: 23

²Numbers 3,4, and 5 have the same weighted rank.

Open house participants were asked to complete a survey questionnaire, similar to the questionnaire contained in the newsletter, if they had not done so already. A ranking of these issue areas, differing slightly from newsletter questionnaire respondents, is included below.

**TABLE 2-2
ISSUES TO BE ADDRESSED IN THE PHILOMATH TSP
OPEN HOUSE RESPONDENTS¹**

Issue	Weighted Rank
Neighborhood traffic issues, e.g., dangerous intersections, speeding, etc.	1
Additional or improved arterial or collector streets to accommodate future growth	2
Improvements in overall traffic circulation	3
Improved/new bicycle facilities	4
Parking	5
Couplet connections	6
Control of access points to Highway 20/34	7
Bypass around Philomath	8
Improvements to pedestrian access across Main Street and in the downtown commercial area	9
Separation of truck traffic through downtown	10
Design of couplet to avoid separating the community	11 ²
Access improvements to the Newton Creek industrial area	12
Design standards for residential streets	13

¹Number of responses: 16

²Numbers 11, 12, and 13 have the same weighted rank.

OPEN HOUSE PROGRAM

The first public open house on the TSP and related studies was held on March 31, 1998, at the Philomath High School Library. Participants were asked to identify specific transportation needs and issues on a map of the city and to respond to a number of miscellaneous questions posted around the room. Over sixty people participated. Attendees were asked to identify where they lived and worked on an aerial photo map of the city and region, to identify areas of site-specific transportation issues and needs on an enlarged map of the city, and to review and comment on the couplet alternative. Maps of existing and future transportation conditions in Philomath were available for review.

Citizens were also invited to review and comment on a number of current and future studies in the area including the following:

- Community Development Survey, to be conducted by Cascades West Council of Governments.
- Highway 20/34 Refinement Study, to be conducted by ODOT.
- Downtown Beautification Project, conducted by the Downtown Beautification Team.
- Newton Creek Industrial Study, conducted by the City of Philomath.

Proposed Couplet

Open house participants were asked to review a map of a proposed couplet through the downtown area and to note what other alternatives should be studied in the TSP. Most people at the open house supported the proposed couplet and had been involved with the development of the alignment. One participant suggested connecting Applegate Street to Main Street through the old church property. Additional comments mentioned at the open house station and in questionnaire responses are listed below:

Open House Station Comments

- Avoid traffic congestion on Applegate Street near school. Will the crossing really go through Citizens Bank?
- East one-way from 15th Street to Applegate Street instead of Main Street – outdoor cafés on Main Street.
- Eastbound Applegate Street cut-through to Main Street between 13th and 16th Streets.

Questionnaire Comments

- Make the couplet going east stay on Applegate Street to 14th or 15th Streets.
- Change the crossover location of the one-way couplet eastbound to the vicinity 15th Street.
- Couplet should go all the way on Applegate Street instead of crossing over.

Site-Specific Needs and Improvements

Participants at the open house, both on a map posted for comment and in the open house survey, as well as newsletter questionnaire respondents identified the following site-specific improvements for analysis in the TSP. The most commonly mentioned issues include the following:

- Connecting Applegate Street with a Newton Creek Bridge.
- Highway 20/34 access to Clemens Mill Road and Philomath Forest Products.
- Possibility of a truck route using Chapel Drive.
- 19th Street and Main Street intersection - too tight for trucks.
- Study a bypass of Highway 20.
- Pedestrian crosswalks with signal activation.
- Concern regarding through traffic on a through Applegate Street due to proximity of schools.

A complete itemization of responses is listed in Appendix C.

Responses to Miscellaneous Questions

Open house participants were asked to respond to the following four miscellaneous questions posted around the room. The number of comments or mentions is listed for each response.

1. *What are the most important actions to be taken to improve transit service?*

Number of Comments, or Mentions	Comment
2	<ul style="list-style-type: none"> Some transportation between Philomath and Corvallis (i.e., the loop from Corvallis to Linn-Benton Community College).
1	<ul style="list-style-type: none"> Or bus during rush hour and smaller vehicle during less busy times with a capacity to respond to demand (telephone request). Part time drivers could agree to be on call as needed and clients would be told when to expect the ride, or else reserve in advance. (Similar to the Dial-a-Bus for any age group.) A few buses could take Philomath kids to Corvallis after school (with parental permission only), to participate in Corvallis activities until their parents finished work and were able to pick them up. Corvallis could be reimbursed either by the parents or from Philomath sources, volunteer, or other.
1	<ul style="list-style-type: none"> If possible, there should be transportation also in the evening and weekends/holidays to make people less dependent on cars.

2. *What are the most important actions to be taken to improve truck traffic through and within the city?*

Number of Comments, or Mentions	Comment
1	<ul style="list-style-type: none"> Keep in mind new truck weights and lengths (for light timing, etc.)
1	<ul style="list-style-type: none"> Alleviate congestion on Highway 20/34 for everyone.
1	<ul style="list-style-type: none"> Route through traffic away from (around) downtown.
1	<ul style="list-style-type: none"> Since the Oregon Highway Plan has designated Highway 20 a major freight system route to the coast, we must have a truck bypass if we are going to be able to maintain livability on and around Main Street.
1	<ul style="list-style-type: none"> A truck bypass; if not, Philomath will be split in two and will lose it's sense of place.

3. *What are the most important actions to be taken to improve bicycle and pedestrian transportation?*

Number of Comments, or Mentions	Comment
1	<ul style="list-style-type: none"> Widen bike path to ten feet with painted middle line.
1	<ul style="list-style-type: none"> Resurface bike path to Corvallis – grass and weeds are growing in some of it.
1	<ul style="list-style-type: none"> Make more bike lanes separate from roadways preferably.

4. How should transportation system improvements be financed?

Number of Comments, or Mentions	Comment
3	♦ Necessity to capture funds from the users of the system, not leave the Philomath taxpayers to provide for the driving convenience of the county and everyone else (e.g., gas, auto, truck, auto parts, tires, etc.)
2	♦ Federal grants for alternative transportation.
1	♦ Increase gas tax (city tax?)
1	♦ User fees/taxes – gas, auto, truck, auto parts, tires, etc.

Future Public Involvement Opportunities

Out of 39 total newsletter and open house questionnaire responses, most respondents who answered this question said that they would like at least to be notified by a newsletter. Often, people said that they would like to be notified in a variety of ways. A complete tabulation of responses is shown below.

**TABLE 2-3
TABULATION OF SURVEY REPSONSES**

Method of Notification/Participation	Responses	Percentage of Total Responses*
Newsletter	23	59
Open houses	17	44
Public hearings	14	36

*Total exceeds 100% as respondents could check as many methods as they wished.

Other comments made regarding future public involvement opportunities include the following.

Comments Mentioned Once

- Newsletters should inform people of the limitations in planning (e.g., budget or need for access at certain points), but should also give busy citizens who cannot get to meetings a chance to comment if they are willing to by questionnaire.
- Let the citizens vote on these so called improvements at the ballot box.
- Only if the public is allowed adequate input – not just the developers, planners and politicians.

Effectiveness of the Open House

Participants in the open house had an additional opportunity to rate the effectiveness of the open house. Most respondents to this question felt that the open house did a good or very good (77 percent) job of providing information on planning issues. Eighty-nine percent of the people who responded felt that the open house did a

good to very good job providing opportunities to give personal input on TSP planning issues. Specific responses are shown in the table below.

**TABLE 2-4
OPEN HOUSE EFFECTIVENESS¹**

	Very Good								Very Poor	
	1	%	2	%	3	%	4	%	5	%
a) Providing information on planning issues	4	44	3	33	2	22	-	0	-	0
b) Providing opportunities to give personal input	7	78	1	11	1	11	-	0	-	0
Totals	11		4		3		-		-	

¹Number of persons responding: Nine

Summary Of Second Open House

As part of the City of Philomath Transportation System Plan (TSP) process, the City solicited public input on recommendations and alternatives developed by staff, consultants and the Traffic and Transportation and Safety Commission (TTSC) for inclusion in the Draft Philomath Transportation System Plan. These recommendations and alternatives were developed from key issues identified during public outreach earlier in the spring. During this phase of draft TSP review, public opinion was again solicited through a newsletter/questionnaire directly mailed to each household and through a public open house on October 22, 1998. The primary focus of the open house was to solicit public feedback on alternatives recommended for:

- Highway 20/34 Main Street (Couplet Options);
- Relocation of Clemens Mill Road;
- Installation of new traffic signals;
- Truck route improvements;
- New roads;
- Bike lanes;
- Pedestrian (multi-use) paths; other
- Demand management options such as transit, and
- Access management strategies.

From the combined questionnaire responses and open house input, the two most favored Highway 20/34 improvement options are the College/Applegate/Main Street couplet option and the "Local Street Improvement" option (maintaining Highway 20/34 through downtown as a three lane roadway and make improvements to College and Applegate Streets to accommodate an increase in local traffic). Questionnaire respondents tend to favor relocating the Clemens Mill Road access across from 26th Street; installing new traffic signals at the Main and 9th Street and Main and 26th Street intersections; reconstructing 13th Street between Chapel Drive and Main Street for truck route improvements; extending Applegate Street over Newton Creek; extending West Hills Road to the Highway 20/34 intersection; and connecting Newton Street to 26th Street. Regarding adding bicycle lanes, extending the bike path from Corvallis to 19th Street received the most support. Respondents also tend to favor constructing new pedestrian paths in a number of locations. The single access management strategy that received the most support at the open house was optimizing traffic signal installation, spacing and coordination. This was

followed by installing curbs, fences, plantings, etc. to prevent uncontrolled access along property frontages and to better define access.

Key Improvements And Alternatives

Public input on key improvements and alternatives was solicited through three mechanisms:

- Direct-mail newsletter questionnaire

A newsletter insert on the draft Transportation System Plan was mailed in October to all City residents. This newsletter contained a questionnaire and an announcement of the draft TSP open house. Forty-three responses (43) to this newsletter have been received to date.

- Public open house

Held October 22, 1998, in the Philomath High School Library, the open house was publicized through the direct mail newsletter, in the Community Development Preference Survey (produced by the Cascades West Council of Governments for the City of Philomath), and in the Corvallis Gazette-Times. Over 50 people attended this open house.

- Open house questionnaire

A copy of the direct-mail questionnaire was distributed to open house participants who had not yet completed the copy mailed to their homes. An additional 15 participants completed and returned this questionnaire on October 22nd. One additional questionnaire from the open house was returned to City Hall after the 22nd.

During the open house, participants reviewed proposals being evaluated regarding Highway 20/34 improvement options including the couplet; other street improvements (including bicycle and pedestrian paths and truck routes); and access management strategies.

Participants also had an opportunity to review results of the October 13 Community Development Preference Survey Open House and fill out survey questionnaires if they had not done so already. Displays regarding the industrial wetlands strategy study were posted as well and consultants were present to answer questions.

Responses to Improvement Options

I. Highway 20/30 Improvement Options – Questionnaire Responses

Newsletter respondents were asked to indicate their opinion about five Highway 20/34 improvement options. Only one option, "Local Street Improvement" (maintaining Highway 20/34 through downtown as a three lane roadway and make improvements to College Street to accommodate an increase in local traffic), received more support than opposition in the combined questionnaire responses. The College/ Applegate/ Main Street couplet option received the next most support. Responses to the city-wide questionnaire were more supportive of this option than were participants who responded to the open house questionnaire. Results may have been influenced by door-to-door contact made by residents along College and Applegate Streets to their neighbors. An additional

petition was submitted to the city with 31 signatures opposing the College/Applegate/Main Street option. Results of questionnaire responses are shown in the following table.

**TABLE 2-5
COUPLET QUESTIONNAIRE RESPONSES**

Proposed projects	1 Strongly support		2		3		4		5 Strongly oppose	
	City-wide	Open House	City-wide	Open House	City-wide	Open House	City-wide	Open House	City-wide	Open House
COUPLET OPTIONS										
▪ Maintain current system (no-build alternative), assumes no roadway improvements	3	1	2	-	3	4	5	1	17	7
Total	4		2		7		6		24	
▪ Couplet option using portions of College, Applegate, and Main streets as recommended in the City's Comprehensive Plan	11	3	7	2	6	-	1	-	12	10
Total	14		9		6		1		22	
▪ Couplet option using Applegate and Main streets	4	2	3	1	3	2	7	2	17	5
Total	6		4		5		9		22	
▪ Widen Highway 20/34 to five lanes	11	8	3	3	3	0	5	0	14	5
Total	19		6		3		5		19	
▪ Maintain Highway 20/34 through downtown as a three lane roadway/improve College to accommodate increased local traffic.	11	2	6	3	4	6	5	1	10	3
Total	13		9		10		6		13	

Options and total responses, on a scale of 1 (strongly agree) to 5 (strongly disagree) shown graphically:

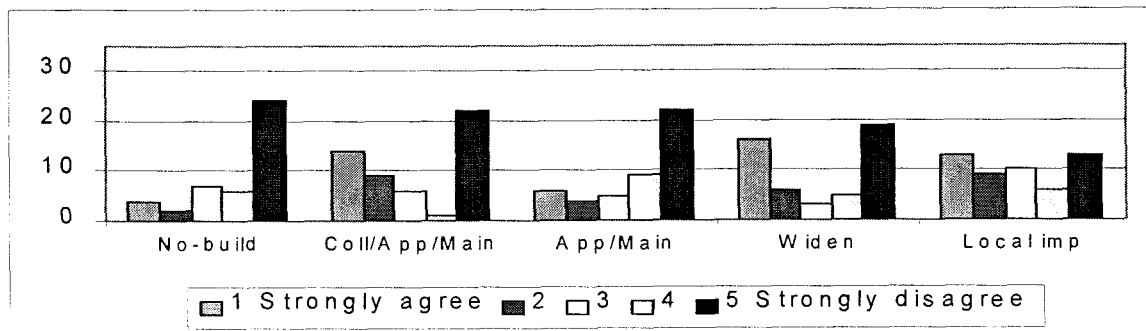

Open House Comments

Open house participants reviewed the five options posted with their identified positive and negative consequences. They marked, with colored dots, which options they agreed with and disagreed with and were asked to give their reasons. In this case, more open house participants agree with the Couplet/Applegate/Main Street option than any other option. There was also significant support for the “Local Street Improvement” option, although more disagreed than agreed. All responses are shown in the following table.

**TABLE 2-6
LOCAL STREET IMPROVEMENT OPTIONS QUESTIONNAIRE RESPONSES**

Highway 20/34 Improvement Options	Agree	Disagree
▪ Maintain current system (no-build alternative), assumes no roadway improvements	3	4
▪ Couplet option using portions of College, Applegate, and Main streets as recommended in the City’s Comprehensive Plan	16	9
▪ Couplet option using Applegate and Main streets	1	19
▪ Widen Highway 20/34 to five lanes	11	16
▪ Maintain Highway 20/34 through downtown as a three-lane roadway and make improvements to College Street to accommodate an increase in local traffic.	14	2

Reasons participants gave for their agreement/disagreement include the following:

1. No-build option

- I support this with installation of bus service and incentives to use buses.
- This would be the best way to keep downtown Philomath as it is, when by-pass can be built to remove non-stopping traffic from town.

2. Applegate/College/Main Street couplet option

- (Agree) Distributes traffic and does not affect elementary and high school student safety.
- Fine – but don’t cut through #1530 Main Street.
- This affects residential safety of our children at school or at home they are playing/ walking outside.
- This removes at least half traffic from businesses making it harder for us to continue to shop in Philomath.
- Turning downtown residential streets into interstate bypasses is a slap in the face to residents and homeowners. Please access existing roads with improvements to facilitate Oregon’s growth. Do not render a mile of residential road unlivable by turning in into a freeway/ throughway.

3. Applegate/Main Street couplet option

- For business, this would cut access in half. Result would probably be dead downtown, like Lebanon.

4. Five lane option

- I feel this is the worst option. Philomath doesn’t need a “9th” Street like Corvallis has. This would make Philomath seem like just another highway/ strip town and not a community with neighborhoods.

- Besides comment about 9th street similarity, it would effectively divide town in half and not speed traffic that does not stop in town.

5. Maintain Highway 20/34 through downtown/ improved local street option

- I prefer this option. This option is relatively low cost and does not have major negative impact on private residence. It seems to offer a partial solution to all of the problems. We all must compromise.
- This improvement will help Philomath shoppers. Then we need to get non-stop traffic around and out of town.
- As long as this does not impact children's safety by increasing traffic on residential streets.
- Tie the "local improvement" Highway 20/34 option with the Applegate extension over Newton Creek. Get local traffic off Highway 20/34 for safety and reduced congestion. Also reduce north/south streets crossing Highway 20/34. It adds some local inconvenience, but will make the lights at 9th and 26th more cost effective! Use vacated north/ south streets for new commercial lots and/or parking.

Other Comments:

- I like the idea of bypassing Philomath completely. Leave this a small community.

II. Clemens Mill Road – Questionnaire Responses

- Three alternative improvements for Clemens Mill Road were presented for review and comment. Of these, relocating the Clemens Mill Road access across from 26th Street received the most support. Total responses are shown in the table on the following page.

**TABLE 2-7
CLEMENS MILL ROAD QUESTIONNAIRE RESPONSES**

PROPOSED PROJECTS	1 Strongly support		2		3		4		5 Strongly oppose	
	City-wide	Open House	City-wide	Open House	City-wide	Open House	City-wide	Open House	City-wide	Open House
CLEMENS MILL ROAD										
Relocate Clemens Mill Road access across from 26 th Street	10	3	3	3	5	2	5	1	6	0
Total	13		6		7		6		6	
Relocate Clemens Mill Road access across from Newton St	2	1	2	1	10	3	3	3	11	0
Total	3		3		13		6		11	
Relocate Newton Street across from Clemens Mill Road	1	0	4	1	6	5	0	2	13	1
Total	1		5		11		2		14	

Options and total responses, on a scale of 1 (strongly agree) to 5 (strongly disagree) shown graphically:

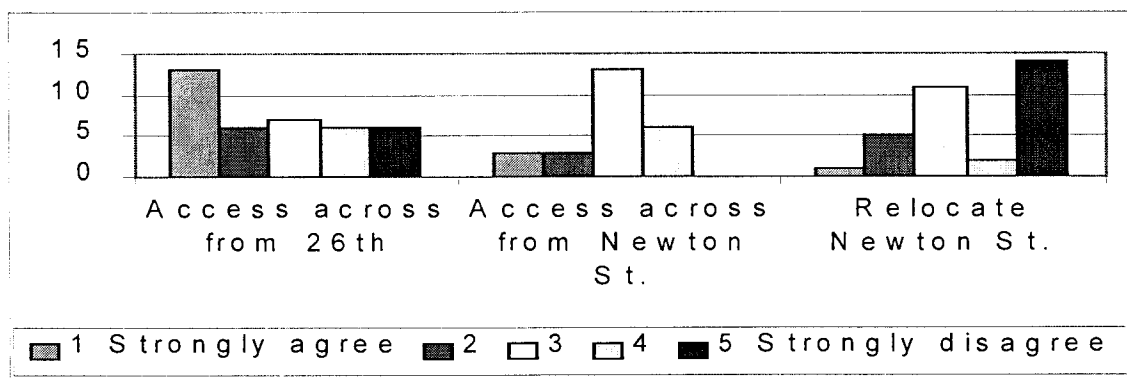

Open House Comments

No comments specific to realignment of Clemens Mill Road were received at the open house.

III. Installation Of New Traffic Signals – Questionnaire Responses

Three locations for new traffic signals were proposed for public review. A new intersection at Main and 26th Street received the most support, followed by a new signal at Main and 9th Street. The proposal to install a new signal at the Highway 20 intersection with Highway 34 received more divided response, as indicated in the following table.

**TABLE 2-8
TRAFFIC SIGNAL QUESTIONNAIRE RESPONSES**

PROPOSED PROJECTS	1 Strongly support		2		3		4		5 Strongly oppose	
	City-wide	Open House	City-wide	Open House	City-wide	Open House	City-wide	Open House	City-wide	Open House
NEW TRAFFIC SIGNALS										
Highway 20/34 intersection	3	6	5	2	11	3	5	2	9	0
Total	9		7		14		7		9	
Main and 9 th Street intersection	15	7	2	2	7	3	4	1	6	0
Total	22		4		10		5		6	
Main and 26 th St. intersectio.:	19	6	6	3	2	2	4	2	3	0
Total	25		9		4		6		3	

Options and total responses, on a scale of 1 (strongly agree) to 5 (strongly disagree) shown graphically:

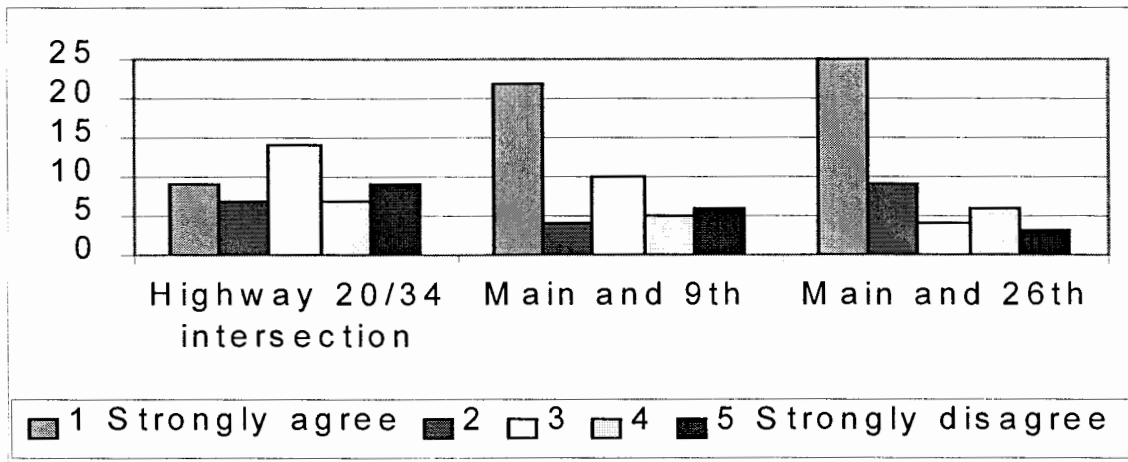

Questionnaire comments on traffic signal include:

- (Regarding: Main and 26th Street intersection) or move east to Clemens Mill Road and Main Street.
- (Regarding: Highway 20 at Highway 34 intersection) poor visibility.

Open House Comments

No comments specific to realignment of Clemens Mill Road were received at the open house.

IV. Truck Route Improvements -- Questionnaire Responses

Of the two proposed truck route improvements, reconstruction of 13th Street between Chapel Drive and Main Street received more support than improvements on Grange Hall Road. The following table illustrate the truck route improvement responses.

**TABLE 2-9
TRUCK ROUTE IMPROVEMENTS QUESTIONNAIRE RESPONSES**

PROPOSED PROJECTS	1 Strongly support		2		3		4		5 Strongly oppose	
	City-wide	Open House	City-wide	Open House	City-wide	Open House	City-wide	Open House	City-wide	Open House
TRUCK ROUTE IMPROVEMENTS										
Reconstruct 13 th Street between Chapel Drive and Main Street	19	2	5	4	6	4	3	2	3	0
Total	21		9		10		5		3	
Improvements on Grange Hall Road including structural improvements at Greasy Creek Bridge (Benton County)	6	1	8	6	5	1	5	1	4	0
Total	7		14		6		6		4	

Options and total responses, on a scale of 1 (strongly agree) to 5 (strongly disagree) shown graphically:

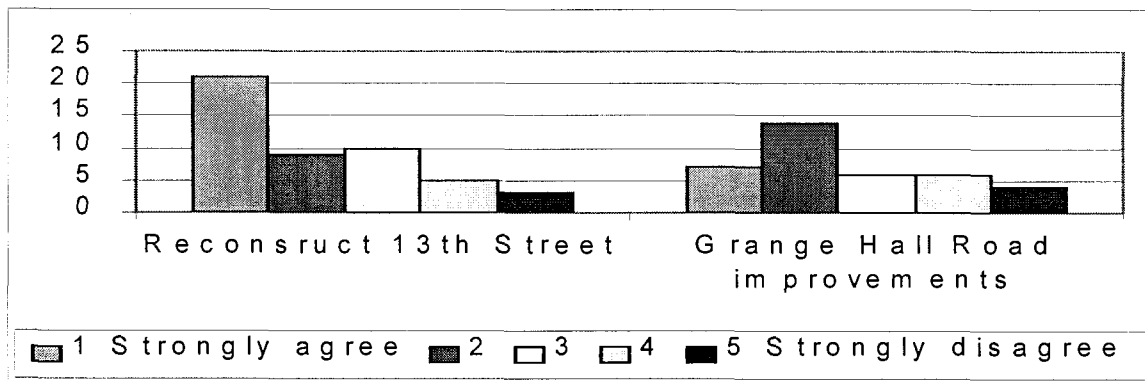

Open House Comments

Three comments regarding the proposed truck routes were made at the open house:

- Continue truck route west from Chapel Hill Drive instead of going down to Grange Hall Road. Turn, as you have it, onto Grange Hall is too sharp. Chip trucks won't make it.
- Take 13th Street north to connect with Industrial Way.

- Southern by-pass would allow both trucks and cars that do not stop in Philomath to not congest city traffic.

V. Construct New Roads – Questionnaire Responses

Five options for new road improvements were presented in the questionnaire and at the open house. An extension of Applegate Street over Newton Creek received the most support, followed by the by-pass option – extending West Hills Road to the Highway 20/34 intersection. All responses are shown below.

**TABLE 2-10
CONSTRUCT NEW ROADS QUESTIONNAIRE RESPONSES**

PROPOSED PROJECTS	1 Strongly support		2		3		4		5 Strongly oppose	
	City-wide	Open House	City-wide	Open House	City-wide	Open House	City-wide	Open House	City-wide	Open House
NEW ROADS										
Between Industrial Way and 13 th Street	9	1	4	2	3	5	3	0	7	2
Total	10		6		8		3		9	
Bellfountain extension	5	1	5	2	3	4	6	0	6	2
Total	6		7		7		6		8	
Applegate extension over Newton Creek	26	7	1	4	2	0	1	1	7	1
Total	34		3		4		2		8	
Bypass option – extend West Hills Road to the Highway 20/34 intersection	14	5	7	0	5	2	5	3	1	1
Total	19		7		7		8		2	
Connect Newton Street to 26 th Street.	11	3	10	3	4	1	1	0	5	0
Total	14		13		5		1		5	

Options and total responses, on a scale of 1 (strongly agree) to 5 (strongly disagree) shown graphically:

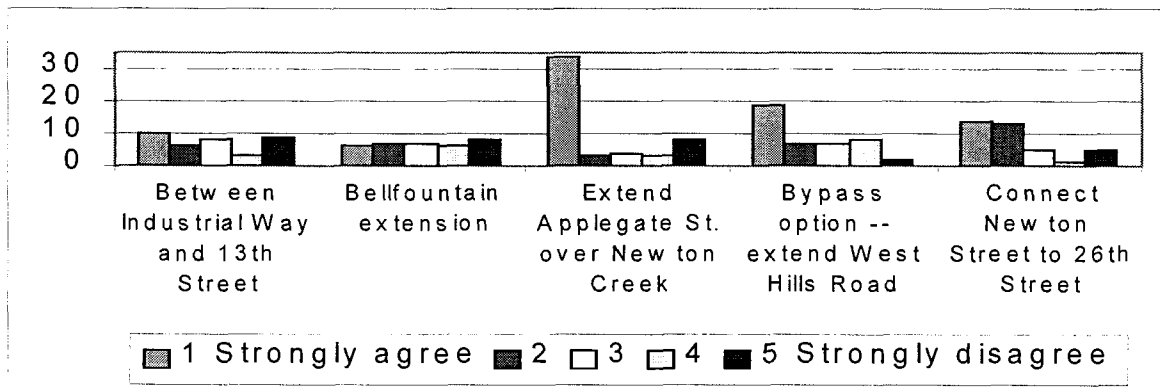

Questionnaire comments

One questionnaire respondent feels particularly strongly about extending Applegate Street over Newton Creek. They commented on the matrix that this is a "stupid idea", also that connecting Newton Street to 26th will create problems for homeowners. Their other comments include:

- Newton Street will be used to bypass traffic on the highway if opened. It was not built for that purpose. Huge mistake to consider. Unfair to homeowners.

Open House Comments

- Extension of Bellfountain (#15) would bisect at least three EFU farmlands, impact the historic Mt. Union Cemetery and negatively affect homes in the area, both south and north of Highway 20/34.
- (#15) Improved access to Mt. Union would be good. Good start on southern by-pass along side Chapel. Could define floodplain and stop growth into river bottom.

VI. Additional Bicycle Lanes -- Questionnaire Responses

Of the five options proposed in the questionnaire, extension of the bike path from Corvallis to 19th Street received the most support. Compared to other improvements, all bicycle lane improvements received considerable support as shown on the following tables.

**TABLE 2-11
ADDITIONAL BICYCLE LANES QUESTIONNAIRE RESPONSES**

PROPOSED PROJECTS	1 Strongly support		2		3		4		5 Strongly oppose	
	City-wide	Open House	City-wide	Open House	City-wide	Open House	City-wide	Open House	City-wide	Open House
ADD BIKE LANES										
With new or along existing streets, e.g., Industrial Way and 13th St.; 19th St. from College St. to Chapel Dr.; along Plymouth Dr. to bike path from Corvallis; and along Bellfountain extension.	16	1	2	3	9	3	3	1	1	0
Total	17		6		12		4		1	
In conjunction with couplet, if constructed	15	3	1	2	7	1	3	3	7	2
Total	18		3		8		6		9	
Along N. 9th St. from Main St. to West Hills Rd.	15	6	6	1	7	4	3	1	1	0
Total	21		7		11		4		1	
Along West Hills Rd. from Wyatt Lane to 19th St.	14	4	4	1	7	3	2	0	1	0
Total	18		5		11		2		1	
Extend bike path from Corvallis to 19th St.	20	7	3	3	6	1	2	0	2	0
Total	27		6		7		2		2	

Options and total responses, on a scale of 1 (strongly agree) to 5 (strongly disagree) shown graphically:

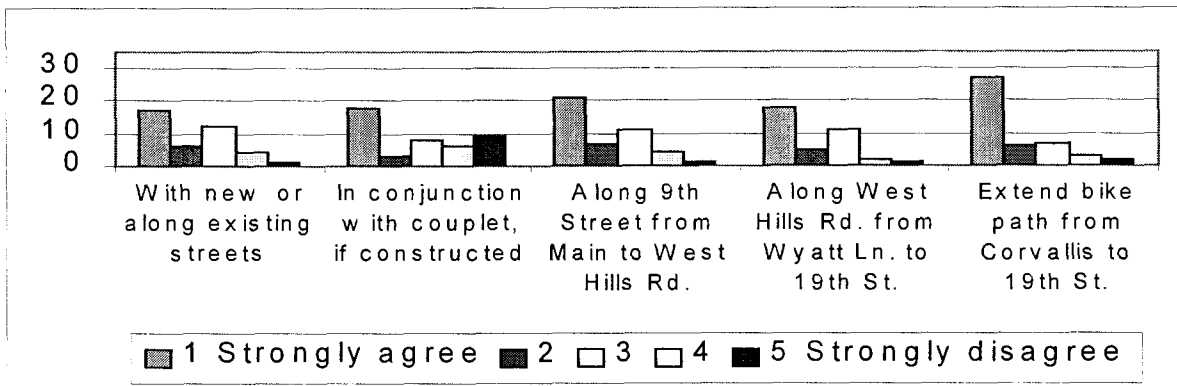

Open House Comments

- Bike paths are needed on all major streets. These should also accommodate skateboards and roller blades.
- Bike paths on major streets, if they don't take parking.

VII. Pedestrian (Multi-use) Paths – Questionnaire Responses

Construction of new pedestrian paths, (for example, from 13th St. to Mary's River; Fern Road along Mary's River; from West Hills Road to the Benton County Park and along Chapel Drive from 13th Street to Chapel Drive) received considerable support in the questionnaire responses as shown below.

**TABLE 2-12
PEDESTRIAN PATHS QUESTIONNAIRE RESPONSES**

PROPOSED PROJECTS	1 Strongly support		2		3		4		5 Strongly oppose	
	City-wide	Open House	City-wide	Open House	City-wide	Open House	City-wide	Open House	City-wide	Open House
PEDESTRIAN (MULTI-USE PATHS)										
▪ New pedestrian paths in a variety of locations, including along Mary's River.	16	6	6	1	6	5	4	0	3	0
Total	22		7		11		4		3	

Total responses, on a scale of 1 (strongly agree) to 5 (strongly disagree) shown graphically:

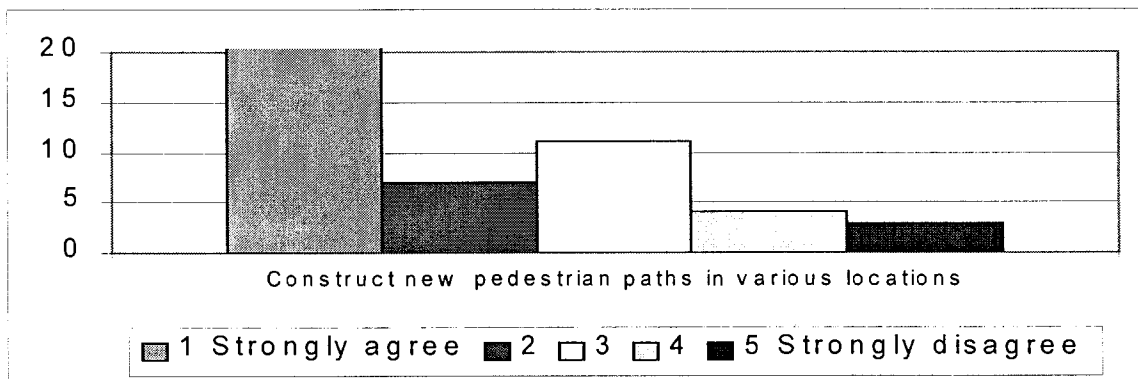

Open House Comments

- (Agree with) Footpaths for seniors who walk to get mail.
- Handicap access on 12th with pedestrian connections to commercial areas.
- Have crosswalks enforced by police.

Transit – Open House Comments

Other open house comments regarding transit included support for an extended Corvallis system and incorporation of train service. Verbatim comments include:

- Hourly bus service as part of Corvallis system. \$1.00 Philomath – Corvallis; \$.75 within Corvallis. Swift service to HP.
- Train!
- Train and bus a must!
- How about bike lanes that link up with the ones' already in place east of town.
- Train maybe – bus definitely = less cars.
- Bus service is absolutely needed. It's amazing that so-called 3rd world countries have mastered public transportation and we have not.

In addition to the matrix responses, one questionnaire comment was received regarding transit:

- I strongly support transportation via bus from Corvallis to downtown Philomath.

Other Open House Comments

Other comments on draft TSP system (TSM/TDM) measures include:

- Appreciate the early turn off at the “y” towards north Corvallis.
- I like the Alsea Highway to West Hills Road bypass.
- Why not use Chapel as a by-pass?
- I live on North 13th so I don't like #13 (Extend 13th and construct a new road between Industrial Way and 13th Street).
- I very much like #11 (Extend West Hills Road to the US Highway 20/ Alsea Highway Intersection).
- #11 would be very expensive, and would not result in improving east-west traffic for Benton County.
- I like #14 (Construct new roads connecting 26th Street to West Hills Road and Chapel Drive).
- Don't like #12 (Extend Applegate Street with a new bridge over Newton Creek) – this creates more high speed traffic near the park.

Other miscellaneous questionnaire comments include:

- Make Cardwell Hill Road go through to relieve congestion in Philomath.
- Please warn residents to wear protective helmets when walking on the new sidewalks. If they should (heaven forbid) glance at a pretty tree or a beautiful flower – they might splatter themselves on a telephone pole, mailbox or other rigid object planted squarely in the cement.

VIII. Access Management Strategies – Open House Comments

Lastly, open house participants reviewed a variety of access management strategies being considered. These measures are proposed to ensure existing roadways can accommodate growth and increased traffic while maintaining safe operations without capital intensive improvements. Participants voted with colored dots on the five strategies that they felt were the most important for the city to pursue.

Strategies that participants agree with more often than they disagree follow, listed in priority of agreement:

1. Optimize traffic signal installation, spacing, and coordination.
2. Install curbs, fences, plantings, etc. to prevent uncontrolled access along property frontages and to better define access.
3. Install or expand one-way operations on the highway.
4. Consolidate access for adjacent properties.
5. Require adequate internal design and circulation plan.
6. Encourage connections between adjacent properties.
7. Regulate maximum number of driveways per property frontages.
8. Provide direct access on lower functional class side streets when available.

Participants strongly disagreed on the following strategy more often than they strongly agreed:

1. Install raised median divider with left-turn lanes at key intersections.
2. Regulate the width of driveways (also total driveway widths per property frontage).
3. Restrict parking on roadway adjacent to driveways to increase driveway turning speeds.
4. Regulate minimum spacing of driveways.

There were no comments on the strategy, “improve the vertical geometrics of the driveway”.

CHAPTER 3: TRANSPORTATION SYSTEM INVENTORY

As part of the planning process, an inventory was conducted of the existing transportation system in the City of Philomath. The City of Philomath Public Works staff assisted the consultant in providing information and data for the inventory. This inventory included the street system as well as the bicycle, pedestrian, public transportation, rail, air, water, and pipeline systems.

STREET SYSTEM

An existing street system inventory was conducted for all arterials, collector streets, and other key local streets within Philomath. Inventory elements include:

- Street classification and jurisdiction;
- Speed limits;
- Street width and right-of-way;
- Number of travel lanes;
- Presence of on-street parking, sidewalks, or bikeways;
- Presence of street shoulders or curbs; and
- General pavement conditions.

Figure 3-1 illustrates the roadway functional classification, as well as the location of traffic signals. Appendix D lists a complete inventory.

State Highways

Discussion of the Philomath street system must include the state highways that traverse the planning area. Although the City of Philomath has no direct control over the state highways, adjacent development, as well as traffic patterns, are heavily influenced by the highways. Philomath is served primarily by two state highways: US 20 and OR Highway 34. These two highway routes join together west of town to form Highway 20/34, which traverses through the heart of the city on Main Street, continuing northeast to the City of Corvallis.

The *1991 Oregon Highway Plan* (OHP) classifies the state highway system into four levels of importance (LOI): interstate, statewide, regional, and district. ODOT has established primary and secondary functions for each type of highway and objectives for managing the operations of each one.

Within the Philomath planning area, US 20 and its continuance as Highway 20/34 through the city is designated as a highway of statewide importance. According to the OHP, the primary function of a statewide highway is to “provide connections and links to larger urban areas, ports, and major recreation areas that are not served directly by interstate highways.” A secondary function is to “provide links and connections for intra-urban and intra-regional trips.” The emphasis on this type of highway is to “provide for safe and efficient high-speed continuous-flow operation in rural areas and high- to moderate-speed operations with limited interruptions of flow in urban and urbanizing areas.” This means that design factors such as controlling access and facilitating the movement of highway traffic efficiently are of primary importance.

OR Highway 34 between Philomath and Waldport is designated as a district level highway. The primary function of a district level highway, according to the OHP, is to “serve local traffic and land access,” with emphasis on

providing “high-speed continuous-flow operation in rural areas” and “moderate- to low-speed operation in urban or urbanizing areas with a moderate to high level of interruptions to traffic flow.” Both of these highways are important routes for through as well as local truck trips. The truck routing and movement of freight are important transportation elements in this TSP.

STREET CLASSIFICATION

The City of Philomath has classified their street system at four levels: major and minor arterials, major collector streets, and local streets. The classification includes state, county, and city roadways.

Arterial Streets

Arterial streets form the primary roadway network within and through a region. They provide a continuous road system, which distributes traffic between regions, districts, and neighborhoods. Generally, arterial streets are high capacity roadways that carry high traffic volumes with minimal localized activity.

In Philomath, Highway 20/34 (Main Street) is classified as a major arterial. Most of the commercial development in the city occurs along this arterial. It is a three-lane facility with a continuous left-turn lane and intermittent on-street parking between the western city limits and 19th Street. Outside this area the highway is a rural two-lane roadway with no on-street parking. OR Highway 34 (Alsea Highway) is a rural two-lane roadway with no on street parking and is classified as a minor arterial in the Benton County draft TSP.

Collector Streets

Collector streets connect local neighborhoods or districts to the arterial network. Within the UGB, Philomath has only six designated collector streets. They are as follows:

- North 9th Street
- 19th Street
- West Hills Road
- Chapel Drive
- Bellfountain Road (Between Chapel Drive and Plymouth Drive)
- 13th Street

Other collector roads outside the UGB, which have direct transportation impacts for the city, are:

- Reservoir Avenue
- West Hills Road (East of Reservoir Avenue)
- Plymouth Drive
- Grange Hall Road

Local Streets

Local streets form the majority of the street system in Philomath. They are designed to carry low traffic volumes, which are associated with the local uses that abut them. In Philomath, the local streets help form part of the street grid system.

STREET LAYOUT

The majority of the Philomath streets are positioned in a grid system. Block sizes vary but are typically 380 feet square. The only area where the street system does not follow a grid-like pattern is in the two residential neighborhoods in the southeastern sector of the city. The placement of winding turns and cul-de-sacs in these neighborhoods is due to natural features such as a creek and hilly terrain.

Highway 20/34 passes through the heart of the city along Main Street in an east-west direction, with intersecting north-south collector streets at 9th Street, 13th Street, and 19th Street.

ROADWAY SAFETY

Accident data within the Philomath city limits were reviewed to identify a select list of locations with potential accident patterns and associated safety concerns. The three sources of accident data reviewed included:

- Accident-specific summaries generated by ODOT's Transportation Development Branch for the three-year period from January 1, 1994 to December 31, 1996; and
- Accident summaries generated from the ODOT Accident Summary Database for locations along OR Highway 34 in Philomath.
- Philomath Police Department traffic crash data from January 14, 1985, to November 10, 1997.

ODOT's Accident Summary Database calculates two useful factors for comparison with statewide statistics based on accident information over the three-year period studied. The first factor is a computed average three-year accident rate, which compares the number of accidents with the average daily traffic (ADT) volume and the length of the segment analyzed. The second factor is the Safety Priority Index System (SPIS) value. This factor evaluates accident frequency, severity, and traffic volumes to create an index for prioritizing state highway locations with safety concerns.

Summary

Table 3-1 lists the four locations that were identified as Philomath high SPIS and/or high-number accident locations based on ODOT accident summary data.

**TABLE 3-1
PHILOMATH ACCIDENT SUMMARY**

Intersection Location	High Accident Number Location¹	High SPIS Location²
Main Street & 19th Street	Yes	Yes
Main Street & 21st Street	Yes	
Main Street & Newton Street	Yes	
Applegate Street & 13th Street	Yes	

¹Based on ODOT Accident Summaries Database - locations with four or more reported accidents during 1994-1996 period.

²Based on ODOT Accident Summary Database 1997 SPIS cutoff value of 42.67 for state highway locations.

Pedestrian Accidents

No ODOT recorded pedestrian accidents occurred in Philomath during the three-year period considered.

Historic Accident Rates

Table 3-2 shows the historic accident rates for US 20 in Philomath as well as the Oregon statewide average for urban non-freeway primary state highways from January 1, 1994 to December 31, 1996. The accident rate for US Highway 20 was well below the statewide average for similar highways in 1994 and 1995 but was about the statewide average in 1996.

**TABLE 3-2
HISTORIC ACCIDENT RATES FOR STATE HIGHWAYS IN PHILOMATH
(Accidents Per Million Vehicle Miles Traveled)**

Highway	1996	1995	1994
US Highway 20			
Philomath urban area (MP 50.11 to MP 52.09)	3.73	2.64	2.75
Average for all Urban Non-freeway Primary State Highways	3.63	3.98	3.45

Source: Oregon Department of Transportation Accident Rate Tables.

Accident Locations (ODOT Records)

Philomath high-number accident locations were chosen based on a review of ODOT-generated accident summaries. All accident locations within the Philomath city limits were considered. Those locations experiencing four or more reported accidents during the three-year period from January 1, 1994 to December 31, 1996, were identified as Philomath high-number accident locations and were further analyzed to determine if accident patterns or other safety-related issues were represented by the data. The four Philomath high-number accident locations,

along with summary information provided from the ODOT accident summaries, are presented in Table 3-3. Supplementary accident information is presented for each location.

**TABLE 3-3
HIGH-ACCIDENT LOCATION SUMMARY
(January 1, 1994 To December 31, 1996)**

Intersection Location	Fatalities	Injuries	Property Damage Only	Total Accidents
Main Street (MP 51.04) & 19th Street	0	14	7	15 ¹
Main Street (MP 51.18) & 21st Street	0	10	1	6
Main Street (MP 51.82) & Newton Street	0	3	2	4
Applegate Street & 13th Street	0	3	2	4
Total	0	30	12	29

¹ Three of the 15 accidents were rear-end type accidents that were coded as occurring approximately 50 feet west of the intersection but were considered related to the operations of this intersection.

Source: Oregon Department of Transportation *Accident Summary Database Investigative Report*.

Main Street (US Highway 20) and 19th Street

Fifteen accidents were reported at this signalized intersection during the three-year period considered, resulting in fourteen injuries. Most accidents (11) occurred during daylight hours and four occurred under wet or icy pavement conditions. Accident types were divided among angle (1), turning (3), rear-end (10), and other maneuver (1) accidents. The primary accident type involved rear-end accidents--six eastbound and four westbound along Main Street. In each rear-end accident, the driver error involved drivers either following too close or traveling too fast to properly stop. The ODOT Accident Summary Database lists this intersection as a high SPIS location (top ten percent of some 14,000 SPIS locations statewide). Its SPIS value of 46.45 for the 1994 to 1996 period exceeds the 1997 cutoff value of 42.67.

Potential Solutions: Short-term improvements to help reduce rear-end accidents could include improved advance signing to caution drivers of an upcoming intersection/traffic signal and/or adjustment of clearance intervals (yellow signal) to reduce abrupt stops.

Main Street (US Highway 20) and 21st Street

Six accidents were reported at this unsignalized T-intersection during the three-year period considered, resulting in ten injuries. Most accidents (5) occurred during daylight hours and one occurred under wet or icy pavement conditions. Accident types were divided among turn (2) and rear-end (4) accidents. The primary accident type involved rear-end accidents; two eastbound and two westbound along Main Street. In each accident, the error involved drivers either following too close or traveling too fast to properly stop. The accident summaries provided no definitive patterns in accident characteristics to suggest that specific intersection operations (signing, striping, etc.) were a contributing factor in any of the accidents. Although driver sight distance for vehicles properly stopped at the existing stop line (measured 21 feet back from the highway edge line) on 21st Street is adequate to the west, it is only approximately 350 feet to the east. Existing street name signs with black lettering on a white background can be difficult to read, except when very near the sign. Changing to white lettering on a green background (Section 2D-39, MUTCD) could improve driver recognition from further distances, which would

likely reduce abrupt stops. This would also provide better notification through the busy intersection used as a route to schools.

Potential Solutions: Since the inventory was done a left turn refuge has been installed for westbound traffic and the intersection has been restricted with a new stop line. A short-term improvement to help reduce rear-end accidents could include enlarged and/or relocated street name signing to improve visibility to drivers.

Main Street (US Highway 20) and Newton Street

Four accidents were reported at this unsignalized T-intersection during the three-year period considered, resulting in three injuries. Most accidents (3) occurred during daylight hours and one occurred under wet or icy pavement conditions. Accident types were divided among turn (1), fixed-object (1), and rear-end (2) accidents. The primary accident type involved rear-end accidents; two eastbound and two westbound along Main Street. In each accident, the error involved drivers either following too close or traveling too fast to properly stop. The accident summaries provided no definitive patterns in accident characteristics to suggest that specific intersection operations (signing, striping, etc.) were a contributing factor in any of the accidents. Obscured sight may have contributed to at least one accident. Sight distance for properly stopped vehicles at the current stop line location, measuring 20 feet back from the highway edge line on Newton Street, is limited. Current westbound sight distance (approximately 350-foot) is diminished by bermed landscaping and a large evergreen tree along Main Street. Current eastbound sight distance (approximately 250 feet) is impeded by a large tree.

Existing street name signs with black lettering on a white background can be difficult to read except when very near the sign. Changing to white lettering on a green background (Section 2D-39, MUTCD) could improve driver recognition from further distances, which would likely reduce abrupt stops.

Potential Solutions: A short-term improvement could include movement of the Newton Street stop line nearer the intersection to increase sight distance to approximately 1,000 feet in each direction. Another short-term improvement to help reduce rear-end accidents could include enlarged and/or relocated white and green street name signing to improve visibility to drivers and/or warning signs of an upcoming side street intersection. A longer term site improvement could involve adding a left-turn refuge lane for westbound traffic.

Applegate Street and 13th Street

Four accidents were reported at this intersection during the three-year period considered, resulting in three injuries. All accidents occurred during daylight hours and two occurred under wet or icy pavement conditions. All accidents involved angle-type maneuvers where drivers "failure to properly yield the right-of-way." The accident summaries provided no definitive patterns in accident characteristics to suggest that specific intersection operations (signals, signing, striping, etc.) were a contributing factor in any of the accidents.

Potential Solutions: Short-term improvements could include raising or relocating stop signs to improve driver visibility. Additional improvements could include movement of stop lines nearer the intersection and/or restriction of on-street parking near the intersection to improve driver sight distance.

Philomath Police Department Traffic Crash Locations

Traffic crash statistics provided by the city of Philomath for the time period between January 14, 1985 and November 10, 1997, were also reviewed. In addition to the ODOT high-number accident intersections, there were three more intersections from the Philomath Police Department traffic crash statistics that had ten or more crashes in the approximately 13 years covered.

Applegate Street and 19th Street

This intersection had 15 traffic crashes recorded in the police records. It currently is stop-controlled with "STOP" signs on the east and west Applegate Street approaches.

Potential Solutions: A short term solution would be to reinstall the STO: signs at this intersection at a higher elevation (seven feet to the bottom of the signs). This would improve visibility of the signs particularly when there are cars parked on the Applegate Street approaches.

Main Street and 13th Street

This intersection had 11 traffic crashes recorded and is controlled by a traffic signal. The traffic signal has left-turn arrows and separate left-turn phases for left turning traffic on US Highway 20. The ODOT records showed no reported accidents in 1994, 1995, or 1996. Based on this information, it appears that this intersection may have a better safety record in recent years.

Potential Solution: A short term improvement would be to install new more visible street name signing.

Main Street and 24th Street

This intersection had 13 traffic crashes recorded and is controlled by a "STOP" sign on 24th Street. This intersection is part of Main Street that has been mentioned as a safety concern area by former Police Chief Richard Raleigh. The traffic safety statistics substantiate the concern for the section from 24th Street to Clemens Mill Road. Traffic volumes are expected to grow on the side streets due to development occurring.

Potential Solution: The addition of a left-turn lane on Main Street (Highway 20/34) would be an appropriate project to improve safety in this section.

GENERAL PAVEMENT CONDITIONS

The OHP requires that pavements be improved and maintained to fair or better condition. The two state highways in the City of Philomath were rated by the Pavement Services Unit of ODOT in 1997. The Corvallis-Newport Highway (US Highway 20), being part of the National Highway System (NHS), was rated using the NHS Objective Rating procedure, while the Alsea Highway, a non-NHS highway, was rated using the more subjective Good-Fair-Poor (GFP) Rating procedure.

According to ODOT's 1997 *Pavement Condition Report*, the Objective Rating procedure rates highways using index values to represent pavement conditions. These index values are based on distress type, severity, and extent present in the pavement surface. Data on distress are collected frequently along the roadways (roughly every 0.1-

mile). For non-interstate highways, data are collected in one direction only, with the assumption that the other direction mirrors the measured pavement condition. Index values range from zero to 100, with larger index values indicating better pavement conditions, and are broken into five descriptive categories: Very Good (99-100), Good (76-98), Fair (46-75), Poor (11-45), and Very Poor (0-10).

The GFP Rating method used for non-NHS highways involves driving highways, conducting a visual survey, and scoring pavement sections with a subjective value. The five rating categories and associated range of values are: Very Good (1.0-1.9), Good (2.0-2.9), Fair (3.0-3.9), Poor (4.0-4.9), and Very Poor (5.0). A brief definition of the GFP pavement condition categories used by ODOT for both asphalt and Portland cement concrete pavements is provided below.

Very Good – Asphalt pavements in this category are stable; display no cracking, patching, or deformation; and provide excellent riding quality. No pavement surfacing improvements are needed.

Concrete pavements in this category provide good ride quality, display original surface texture, and show no signs of faulting (vertical displacement of one slab in relation to another). Jointed reinforced pavements display no mid-slab cracks and continuously reinforced pavements may have tight transverse cracks with no evidence of spalling (or chipping away).

Good – Asphalt pavements in this category are stable and may display minor cracking (generally hairline and hard to detect), minor patching, and possibly some minor deformation. These pavements appear dry or light colored, provide good ride quality, and display rutting less than 1/2 inch deep.

Concrete pavements in this category provide good ride quality. Original surface texture is worn in wheel tracks exposing coarse aggregate. Jointed reinforced pavements may display tight, mid-slab transverse cracks and continuously reinforced pavements may show evidence of minor spalling. Pavements may have an occasional longitudinal crack but no faulting is evident.

Fair – Asphalt pavements in this category are generally stable displaying minor areas of structural weakness. Cracking is easier to detect, patching is more evident (although not excessive) and deformation is more pronounced and easily noticed. Ride quality is good to acceptable.

Concrete pavements in this category provide good ride quality. Jointed reinforced pavements may display some spalling at cracks and joint edges with longitudinal cracks appearing at less than 20 percent of the joints. A few areas may require a minor level of repair. Continuously reinforced pavements may show evidence of spalling with longitudinal cracks appearing in the wheel paths on less than 20 percent of the rated section. Shoulder joints may show evidence of deterioration and loss of slab support and faulting may be evident.

Poor – Asphalt pavements in this category are marked by areas of instability, structural deficiency, large crack patterns (alligatoring), heavy and numerous patches, and visible deformation. Ride quality ranges from acceptable to poor.

Concrete pavements in this category may continue to provide acceptable ride quality. Both jointed and continually reinforced pavements display cracking patterns with longitudinal cracks connecting joints and transverse cracks occurring more frequently. Occasional punchout (or pothole) repair is evident. Some joints and cracks show loss of base support.

Very Poor – Asphalt pavements in this category are in extremely deteriorated condition marked by numerous areas of instability and structural deficiency. Ride quality is unacceptable.

Concrete pavements in this category display a rate of deterioration that is rapidly accelerating.

State Highways

According to the 1997 ODOT *Pavement Condition Report*, the section of US Highway 20 (Main Street) within the Philomath urban area between the western city limits and Newton Creek Bridge (MP 50.11 to MP 51.31) is in poor condition. The section of US Highway 20 (Main Street) from the Newton Creek Bridge to the eastern city limits (MP 51.31 to MP 52.09) is in fair condition. The Alsea Highway from Grange Hall Road to US Highway 20 (MP 58.03 to MP 58.56) is in fair condition.

Collectors

The ODOT Pavements Unit published a 1994 report entitled, *Pavement Rating Workshop, Non-National Highway System*. This report thoroughly defines the characteristics that pavements must display to be categorized under the GFP system. The report also provides color photographs of roadways that display these characteristics, which aids in field investigation and pavement condition rating. These established guidelines were used in conducting a subjective evaluation of pavement condition for all collector streets within Philomath during January 1998.

Nearly all of Philomath's collector streets were found to be in fair or better pavement condition. Approximately 24 percent of the roughly seven miles of collectors were in good condition, another 74 percent were in fair condition, and the remaining two percent were in poor condition. The worst pavement condition was found along Mt. Union Avenue, which was in poor condition.

Other Roadways

Other roadways of local interest were rated in Philomath using the subjective GFP rating system, including Applegate Street, College Street, Grange Hall Road, and Fern Road, representing nearly three and one half miles of roadway. Of these roadways, roughly 12 percent were found to be in good condition, another 29 percent were in fair condition, and the remaining 59 percent were found to be in poor pavement condition. College Street and Grange Hall Road accounted for all of the poor condition pavement.

BRIDGES

The Oregon Department of Transportation maintains an up-to-date inventory and appraisal of Oregon bridges. Part of this inventory involves the evaluation of three mutually exclusive elements of bridges. One element identifies which bridges are structurally deficient. This is determined based on the condition rating for the deck, superstructure, substructure, or culvert and retaining walls. It may also be based on the appraisal rating of the structural condition or waterway adequacy. Another element identifies which bridges are functionally obsolete. This element is determined based on the appraisal rating for the deck geometry, underclearances, approach roadway alignment, structural condition, or waterway adequacy. The third element summarizes the sufficiency ratings for all bridges. The sufficiency rating is a complex formula which takes into account four separate factors to obtain a numeric value rating the ability of a bridge to service demand. The scale ranges from zero to 100 with

higher ratings indicating optimal conditions and lower ratings indicating insufficiency. Bridges with ratings under 55 may be nearing a structurally deficient condition.

ODOT maintains bridge inventory data for one bridge within the City of Philomath. It is located along Highway 20/34 (Corvallis-Newport Highway) crossing over Newton Creek and is state-owned and maintained. The ODOT bridge inventory information indicates that this bridge (ODOT Bridge No. 01186) is functionally obsolete, however, no bridge improvements are scheduled under ODOT's 1998-2001 Statewide Transportation Improvement Program (STIP). The only other bridge in Philomath is the pedestrian bridge across Newton Creek at Applegate Street and it is in good condition.

BICYCLE FACILITIES

The *Oregon Bicycle and Pedestrian Plan* (OBPP) recognizes four bicycle design treatments: multi-use paths, bike lanes, shoulder bikeways, and shared roadways. Philomath's existing bicycle network, although limited, incorporates all four types of bicycle facilities. These existing bike facilities are shown in Figure 3-2. A description from the OBPP of each of the four types of bicycle facilities is necessary:

- A multi-use path is a path physically separated from motor vehicle traffic used by bicyclists, pedestrians, joggers, skaters and other non-motorized travelers.
- A bike lane is officially designated through signing and striping to create an exclusive or preferential travel lane for bicyclists.
- A shoulder bikeway accommodates bicyclists on a hard shoulder of the road typically at least four feet wide (six feet or more preferred). This provides better and safer separation of cyclists from motorists.
- A shared roadway facility is one where motorists and cyclists occupy the same roadway and typically includes roadways without bike lanes or shoulder accommodations. This can be a problem on roads with heavy traffic, high speeds (generally >25 mph), or hills.

It should also be noted that four bicycle facilities connect Philomath and Corvallis. They are as follows:

- Country Club Road (Corvallis) to US Highway 20 to Philomath (multi-use path);
- North 53rd Street to Reservoir Road to West Hills Road to 19th Street ending at College Street (bicycle lanes);
- US Highway 20 from Corvallis to 19th Street in Philomath (shoulder bikeway); and
- Plymouth Road from 53rd Street to Bellfountain Road, south along Bellfountain beyond Chapel Road (shoulder bikeway).

PEDESTRIAN FACILITIES

The city of Philomath lacks sidewalk connectivity along one or both sides of many roadways maintained by the city, county, and state. As a result, pedestrians must frequently share the road with cars. Many sidewalk segments also lack curb cuts for wheelchair access. The city has developed, and is in the second year of implementing, a comprehensive ten-year sidewalk development plan to address these deficiencies along roadways under their jurisdiction. Under the plan, all city streets with curb and gutter will be retrofitted with sidewalks.

A pedestrian bridge along Applegate Street at 23rd Street provides a direct connection between neighborhoods currently bisected by Newton Creek. The bridge provides access for residents in the developing southeastern quadrant of town to community resources including the city park and Philomath's schools. A multi-use path connects Philomath residents with community resources in Corvallis such as Avery Park. The existing western terminus of the path in Philomath is located along Applegate Street just west of 27th Street.

TRANSIT SERVICE

Intercity transit service in Philomath is provided by the Valley Retriever, which makes three round trips per day between Newport, Philomath, Corvallis and Albany. Greyhound bus service is available in Corvallis and Albany. There is no regularly scheduled service for local trips in the Corvallis/Philomath area. Dial A Bus service is available in addition to several other on demand transportation services for the disadvantaged in Benton County.

RAIL SERVICE

The freight rail service in Philomath is provided by the Willamette & Pacific Railroad, which is a private provider. The rail infrastructure (tracks) is shown on Figure 3-1 as the Southern Pacific Company Railroad (prior operation). Currently, there is no regularly scheduled passenger rail service to and from Philomath.

As a grade crossing safety measure, three crossings have recently been closed (8th, 10th, and 12th Streets). This will result in more traffic crossing the railroad at 7th, 9th and 13th Streets with street improvements and signalization. There is only one crossing on Highway 20/34 at the railroad spur to the Boise Cascade mill.

AIR SERVICE

Air service is provided at the Corvallis Municipal Airport, which is outside the Philomath UGB area however there are no regularly scheduled commercial flights. The nearest regular commercial air service is at Eugene. The Corvallis Municipal Airport is located approximately 5 miles southeast from Philomath. According to the "1997 Transportation Volume Tables" by ODOT the Corvallis Municipal Airport has an estimated 83,000 operations (take offs and landings) per year.

WATERBORNE TRANSPORTATION

There is no water transportation in the City of Philomath.

PIPELINES

There are no major transportation pipelines in the City of Philomath.

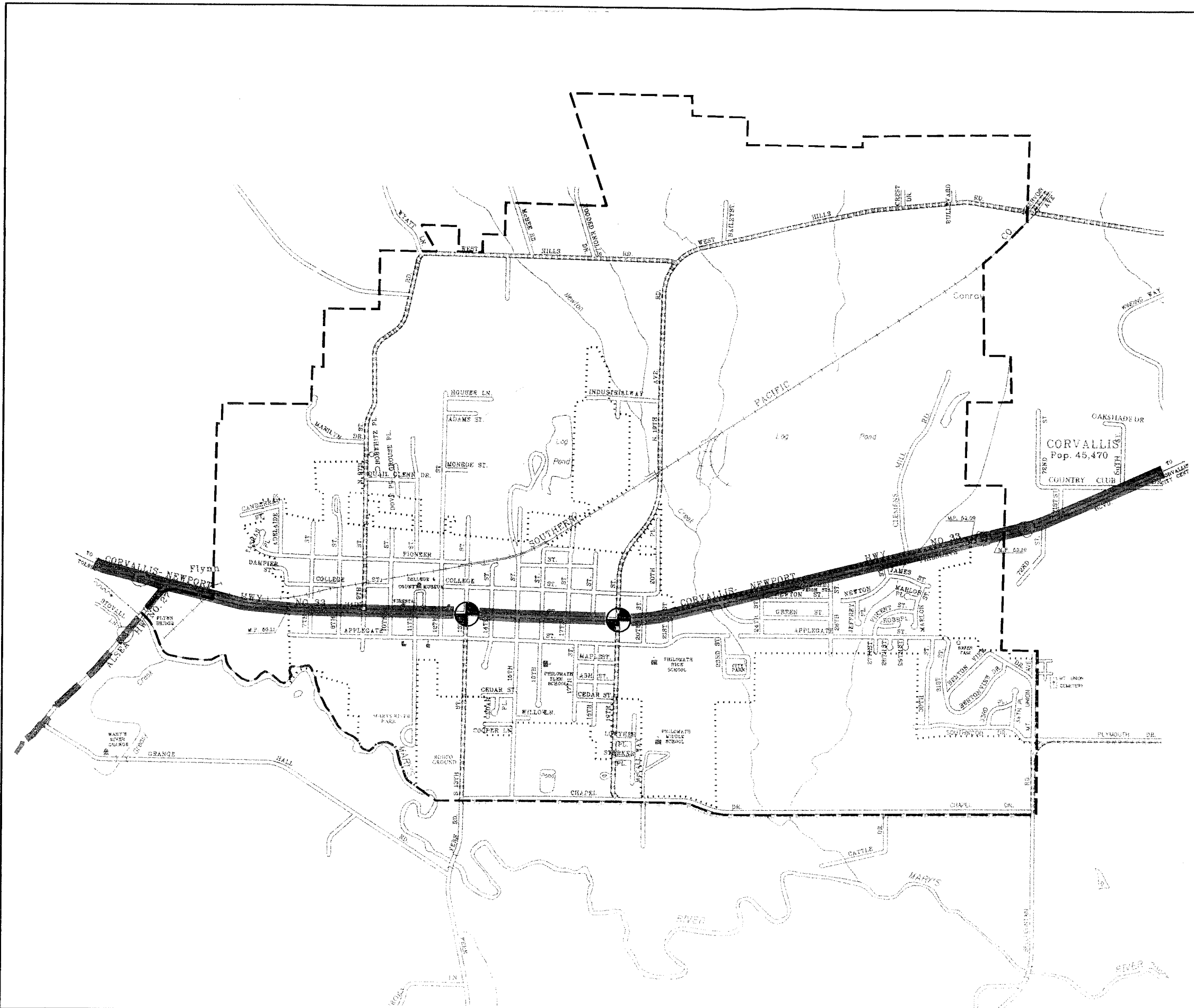

(NOT TO SCALE)

LEGEND:

- URBAN GROWTH BOUNDARY
- CITY LIMITS
- == MAJOR ARTERIAL
- == MINOR ARTERIAL
- COLLECTOR STREET
- LOCAL ROAD
- ⊕ EXISTING TRAFFIC SIGNAL

FIGURE 3-1

Existing Street Classifications and Traffic Signals

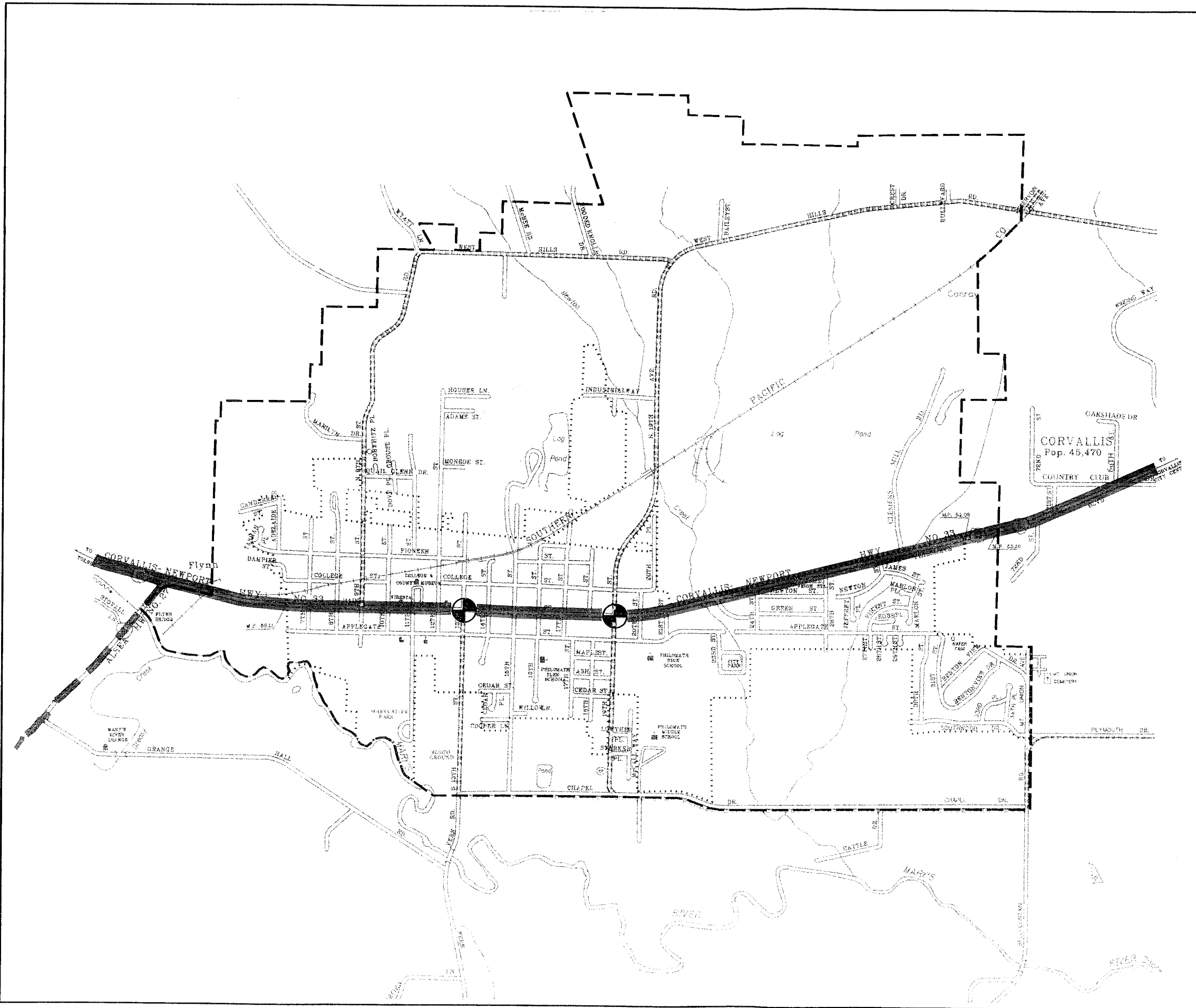

(NOT TO SCALE)

LEGEND:

- URBAN GROWTH BOUNDARY
- CITY LIMITS
- ▬ MAJOR ARTERIAL
- ▬ MINOR ARTERIAL
- ▬ COLLECTOR STREET
- ▬ LOCAL ROAD
- ⊕ EXISTING TRAFFIC SIGNAL

FIGURE 3-1

Existing Street Classifications and Traffic Signals



(NOT TO SCALE)

LEGEND:

- URBAN GROWTH BOUNDARY
- CITY LIMITS
- ▬ BIKE LANE *STRIPED AND SIGNED*
- ▬ SHOULDER BIKEWAY
- SHARED ROADWAY
- ▬ MULTI-USE PATH

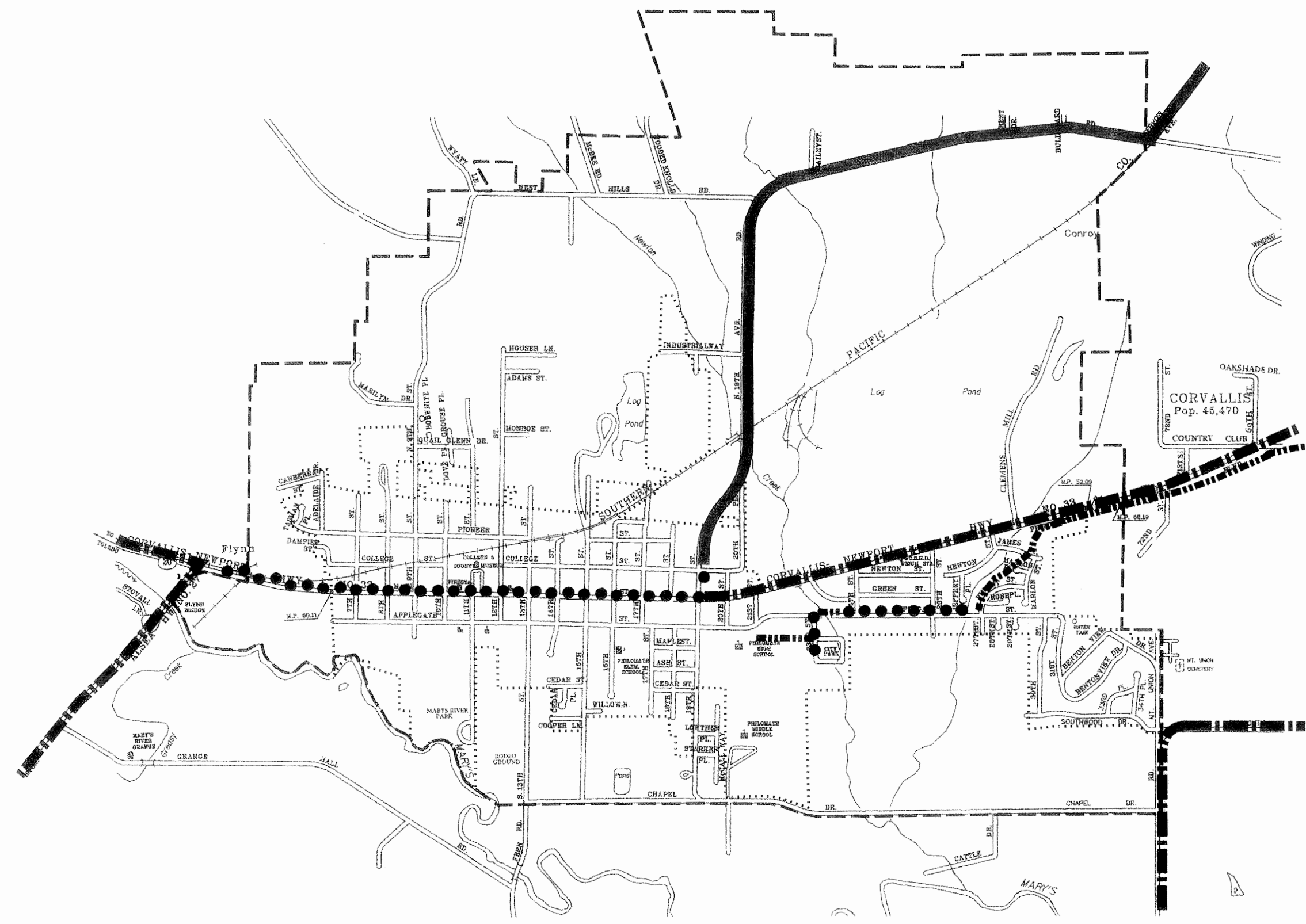

ODOT0254/FIG3-2.DGN/TNT/08-20-96

FIGURE 3-2

Existing Bicycle Facilities

CHAPTER 4: CURRENT TRAFFIC CONDITIONS

As part of the planning process, the current operating conditions for the Philomath transportation system were evaluated.

TRAFFIC VOLUMES

Existing 1996 traffic volumes were determined along all arterial and collector streets as well as critical local streets in the Philomath area. This was done by collecting current and recent traffic volume information. Such information includes the 1991 Corvallis/Philomath traffic model (both ADT and PM peak hour model output), traffic volume information from the *1994 Neabeck Development Traffic Impact Study*, 1995 ADT volumes collected by Benton County, ODOT's 1996 *Daily Traffic Volume Tables*, daily road tube counts performed by the Philomath Department of Public Works in September 1997, and turning movement counts performed by the Philomath Department of Public Works at various intersections in April 1998.

Average Daily Traffic

The 1996 average daily traffic (ADT) volumes on the major streets in Philomath are illustrated in Figure 4-1.

Highway 20/34 (Main Street) is the major traffic facility in Philomath, with ADT volumes ranging between 12,000 vehicles per day (vpd) and 14,900 vpd within the city limits. Over the two years after 1994, this section of highway has experienced moderate growth as volumes increased by about 3.7 percent each year.

West of the city limits, US Highway 20 and OR Highway 34 separate where ADT volumes reached 9,000 vehicles on US Highway 20 to the west and 3,700 vehicles on OR Highway 34 to the southwest.

Nineteenth Street, north of Main Street, is classified as a major collector, with ADT volumes between 4,000 and 4,500 vehicles.

Other streets, which parallel Main Street (such as Applegate Street and College Street) or intersect at Main Street reached ADT volumes up to around 3,000 vehicles.

Hourly Traffic Patterns

Generally, traffic volumes on Philomath roadways peak twice each day, with an AM peak around 7:00 to 8:00 a.m. and a PM peak in the late afternoon around 4:30 to 5:30 p.m.

The hourly traffic patterns at the key intersection of US Highway 20 at OR Highway 34 in Philomath are shown in Figure 4-2. These patterns are based on the 12-hour turning movement count performed by City of Philomath employees in April 1998. This intersection has been identified as one of the high traffic activity spots in the Philomath area.

**FIGURE 4-2
HOURLY TRAFFIC PATTERNS
US Highway 20 at OR Highway 34
(April 1998)**

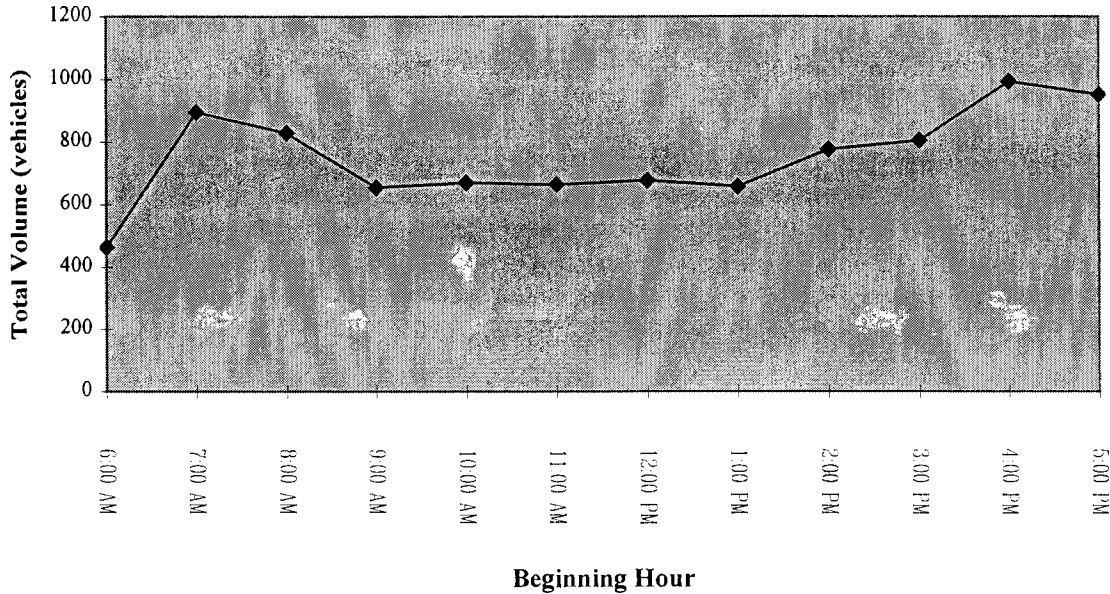

Analysis of this intersection revealed that traffic volumes increase sharply in the morning, peaking at about 900 vehicles per hour (vph) around 7:00 a.m., then dropping down to 650 vph until increasing again to around 1,000 vph around 4:00 p.m.

Weekday PM Peak Hour Volumes

Observing the hourly traffic patterns from the manual turning movement counts taken at all key intersections, the period of highest activity for an average weekday in Philomath seems to occur between 3:00 and 6:00 p.m.; therefore, testing and evaluating the street system was based on the PM peak hour in this time interval.

Directional PM peak hour volumes for 1996 are shown on Figure 4-3.

Many of the traffic volumes displayed in the figure have been taken directly from the 1991 Corvallis/Philomath EMME/2 traffic model as the traffic volumes for this period more accurately represent conditions for 1996. These volumes were checked against more recent available traffic volume information and traffic counts by city staff.

However, the traffic volumes along two sections of state highways have been manually adjusted to reflect more accurate volumes for 1996. These sections are located along US Highway 20 west of the Alsea Highway intersection, and Highway 20/34 east of the Alsea Highway intersection. A comparison between the 1991 model output and existing 1996 ADT volumes at these two locations showed that the 1991 model volumes were overestimated. These volumes were, therefore, adjusted to represent more reasonable numbers, using a peak hour percentage of ten percent of the ADT.

The traffic pattern for the PM peak hour is similar to the daily traffic patterns. Traffic volumes are highest on the two state highways and North 19th Street. Volumes on these roadways steadily increase as the roadways approach the downtown core from the outlying area.

TRAFFIC OPERATIONS

Transportation engineers have established various standards for measuring the traffic operations of intersections and roadways. Each standard is associated with a particular level of service (LOS). The LOS concept requires consideration of factors that include traffic demand, capacity of the intersection or street, delay, frequency of interruptions in traffic flow, relative freedom for traffic maneuvers, driving comfort, convenience, and operating cost. Six standards have been established ranging from LOS "A" where traffic flow is relatively free flowing to LOS "F" where the street system is totally saturated with traffic and movement is very difficult.

The minimum operating standards for streets and intersections in most city jurisdictions in Oregon require a LOS standard of D or better. This standard represents conditions where delays may be long, but not excessive, and only occur temporarily during peak periods. Highway 20/34 in Philomath is also designated as a highway of statewide importance in the OHP. For this type of highway to be located in an "Urban" or "Part of a Metropolitan Area," the OHP requires a design standard of LOS D or better. Some speculation may be made about the urban characteristics of the Philomath area, but the city does have an urban growth boundary and is expected to be a part of the Corvallis Metropolitan Planning Organization (MPO) area well within the 20 year planning period of this study. Therefore, acceptable standards for minimal levels of service should be LOS of D or better along all roads and at all intersections in the Philomath area.

Existing traffic operations were determined along key roadway sections and at critical signalized and unsignalized intersections in Philomath to determine if this minimal level-of-service standard is met.

Roadway Capacity

An analysis was performed to determine if any capacity deficiencies currently exist along key streets in the Philomath area. One way to assess this is to observe the volume-to-capacity (v/c) ratios along sections of the roadway in question. The v/c ratio is a measure of a roadway's capacity to the traffic demand on that road. It can be determined by dividing the PM peak hour traffic demand for a given roadway segment by the roadway's hourly capacity. The capacity of a roadway is based on geometrical characteristics such as the number of travel lanes, the presence of left-turn lanes, and design speed. It is also based on the amount of delay expected due to congestion or its location within a rural or urban environment. A description of the hourly capacities used and the traffic model plots are included in Appendix E.

Roadway Operations

One area of particular concern in Philomath is along Highway 20/34 (Main Street) between the Alsea Highway and 19th Street where traffic volumes and congestion are higher than in any other part of the city.

Analysis of existing traffic volumes and v/c ratios from the EMME/2 model reveal that a section of Highway 20/34, from the Alsea Highway to 19th Street, is currently experiencing heavy traffic flow and congestion during the PM peak hour. Between the Alsea Highway and 13th Street, actual v/c ratios range between 0.62 and 0.87

during the PM peak hour. Traffic operations along this section of highway are expected to be at LOS C to D during this period. Between 13th Street and 19th Street, v/c ratios range between 0.79 and 0.97, indicating that traffic operations are worse, most likely at a LOS E or F.

The draft of the *Benton County Transportation System Plan*¹ indicates that a LOS C exists for the highway between the Alsea Highway and 13th Street and a LOS E exists between 13th Street and 19th Street, which indicates conditions are slightly better than the v/c ratio analysis indicates.

East of 19th Street and inside the city limits, v/c ratios range between 0.60 and 0.88, indicating a moderate level of congestion (LOS C to D).

Intersection Operations

The existing traffic operations were determined at several key signalized and unsignalized intersections in the Philomath area. A total of seven key intersections have been identified for operations analysis. These intersections include:

- US Highway 20 at OR Highway 34
- Highway 20/34 (Main Street) at 13th Street
- Highway 20/34 (Main Street) at 19th Street
- Applegate Street at 13th Street
- Applegate Street at 19th Street
- Highway 20/34 (Main Street) at 9th Street
- Highway 20/34 (Main Street) at 26th Street

Turning movement counts were performed at the first five intersections by City of Philomath personnel in April 1998. The manual turning movement count performed at the first intersection (US Highway 20 at OR Highway 34) was taken over a 12-hour period from 6:00 a.m. to 6:00 p.m. The next four intersections were observed during their PM peak period, which occurs between 3:00 p.m. and 6:00 p.m. The remaining two intersections were not counted, but PM peak hour volumes at these intersections were estimated using the turning movement counts at adjacent intersections and the 1996 PM peak hour traffic volume estimates from the EMME/2 model.

Detailed results of the operations analyses for all key intersections are located in Appendix E. .

Signalized Intersections

Traffic operations at selected signalized intersections were analyzed using ODOT's SIGCAP-2 software. SIGCAP-2 is a capacity analysis program designed to calculate the Level-of-Service, and the level of saturation, or volume-to-capacity ratio, for individual movements based on traffic demand. A technical summary of the methodology used to determine these factors is located in Appendix E.

Currently, there are only two signalized intersections in the Philomath area: Main Street at 13th Street and Main Street at 19th Street. Table 4-1 displays the current operations at these intersections. Conditions are for the PM peak hour for an average weekday.

¹ *Benton County Transportation System Plan Draft Report*, published June 1998, Kittelson and Associates., Inc..

**TABLE 4-1
CURRENT LEVEL OF SERVICE AT
SIGNALIZED INTERSECTIONS**

Location	LOS
<i>Main Street (Hwy 20/34)</i>	
at 13th Street	B
at 19th Street	C

Overall, both signalized intersections currently operate at a LOS of C or better, which is acceptable.

Unsignalized Intersections

The remaining five intersections are unsignalized. Current operations at these intersections were analyzed using ODOT's UNSIG10 software. The level-of-service criteria used in this program for unsignalized intersections can be found in Appendix E. Table 4-2 displays the results of the analysis. LOS is shown for all critical movements.

**TABLE 4-2
CURRENT LEVEL OF SERVICE
AT SELECTED UNSIGNALIZED INTERSECTIONS**

Location	Critical Movement	LOS
Hwy 20 and Hwy 34	Northbound; Left	C
	Northbound; Right	A
	Westbound; Left	A
Main Street and 9th Street	Eastbound; Left	A
	Westbound; Left	A
	Southbound; All	D
	Northbound; All	D
Main Street and 26th Street	Westbound; Left	A
	Northbound; All	D
Applegate Street and 13th Street	All Movements	A
Applegate Street and 19th Street	All Movements	A

EXISTING SIGNAL WARRANTS

A concern has been raised about the necessity for additional traffic signals along Main Street (Highway 20/34) throughout the city, to improve access from intersecting side streets and to provide for pedestrian crossings. Inspection of current traffic volumes, intersection operations, and probable locations of new traffic signals indicates three likely locations: the intersection of US Highway 20 at OR Highway 34, Main Street at 9th Street, and Main Street at 26th Street. Each of these intersections has the highest amount of traffic accessing Main Street (Highway 20/34) at unsignalized intersections. These intersections are also the most likely locations for future traffic signals since the traffic signals would be approximately equidistant from each other. This would allow for favorable traffic signal progression with two-way traffic along the highway. The spacing between signals would not be a determining factor for one-way street operations.

To determine where traffic signal warrants could be met at this time, a signal warrant analysis was performed at each intersection. This analysis was based on existing traffic count information.

The signal warrant analyses were performed using *The Manual on Uniform Traffic Control Devices*, 1988 (MUTCD). The MUTCD states that "Traffic control signals should not be installed unless one or more of the signal warrants in this manual are met." ODOT typically only installs traffic signals when the Minimum Vehicular Volume Warrant, Interruption of Continuous Traffic Warrant or Accident Warrant is met. A detailed description of each signal warrant analysis is located in Appendix E.

Results from the analysis including which warrants were met, are summarized below in Table 4-3.

**TABLE 4-3
SIGNAL WARRANT ANALYSIS
AT SELECTED UNSIGNALIZED INTERSECTIONS**

Intersection Location	Warrants Satisfied
Hwy 20 at Hwy 34	11 - Peak Hour Volume
Main Street and 9th Street	11 - Peak Hour Volume
Main Street and 26th Street	None at this time.

EXISTING TRUCK ROUTES AND TRAFFIC

The main trucking route in the City of Philomath is along state Highway 20/34 on Main Street. This route provides the most direct east-west connection between the larger cities of Corvallis and Albany to the east along Highway 20/34 and the coastal cities of Newport along Highway 20 and Waldport along Highway 34 to the west. Between 19th Street and the Alsea Highway west of town, Highway 20/34 is the only east-west connection for truck traffic in Philomath. There are other partial east-west truck routes which are less direct and less traveled than Highway 20/34. These routes include West Hills Road/Reservoir Road to North 19th Street providing access to the western portions of Corvallis, and Plymouth Drive/Bellfountain Road to South 19th Street serving the southern portion of Corvallis and Pacific Highway to the southeast. East of Philomath in the City of Corvallis, the north-south road of 53rd Street intersects Reservoir Road, West Hills Road, Highway 20/34, and Plymouth Drive providing truckers with a choice of multiple routes.

Weight limits and other restrictions prevent truck traffic on several major roads in the Philomath area. They include:

- Grange Hall Road: Weight limits on the Greasy Creek Bridge prevent most trucks from using Grange Hall Road between the Alsea Highway and Fern Road. (Weight limits are as follows: three-axle [24 tons], five-axle [37 tons], and six-axle [34 tons].)
- 13th Street: A 12-ton weight limit exists on this road exist between Chapel Road and Main Street.
- Applegate Street: A four-ton weight limit exists along most of this road.
- College Street: A four-ton weight limit exists along this road.

- 15th Street: This road is used by local truck traffic only and passes through a residential area between Chapel Street and Main Street.
- 9th Street: North of Main Street, this road passes through a residential area and has a series of extreme horizontal and vertical curves making this route an unlikely route for trucks. Currently, there is a four-ton weight limit.

Figure 4-4 identifies the existing routes, not restricted by weight limits for trucks, in the Philomath area and the truck volumes on these routes. Truck volumes shown for the PM peak hour were obtained from turning movement counts performed at three key intersections along Highway 20/34, at the Alsea Highway, 13th Street, and 19th Street. Daily truck volumes shown in the figure were determined from the 12-hour count (6 a.m. to 6 p.m.) performed at the US Highway 20 and Alsea Highway intersection. Applying an adjustment factor of 1.25 to account for 24-hour truck traffic, it was determined that daily truck volumes represent approximately 11 percent of the overall ADT volumes. This factor was then applied to the ADT volumes along other sections of Highway 20/34 (Main Street) through town to obtain estimates for daily truck volumes.



(NOT TO SCALE)

LEGEND:

--- URBAN GROWTH BOUNDARY

..... CITY LIMITS

2,000 ADT VOLUMES

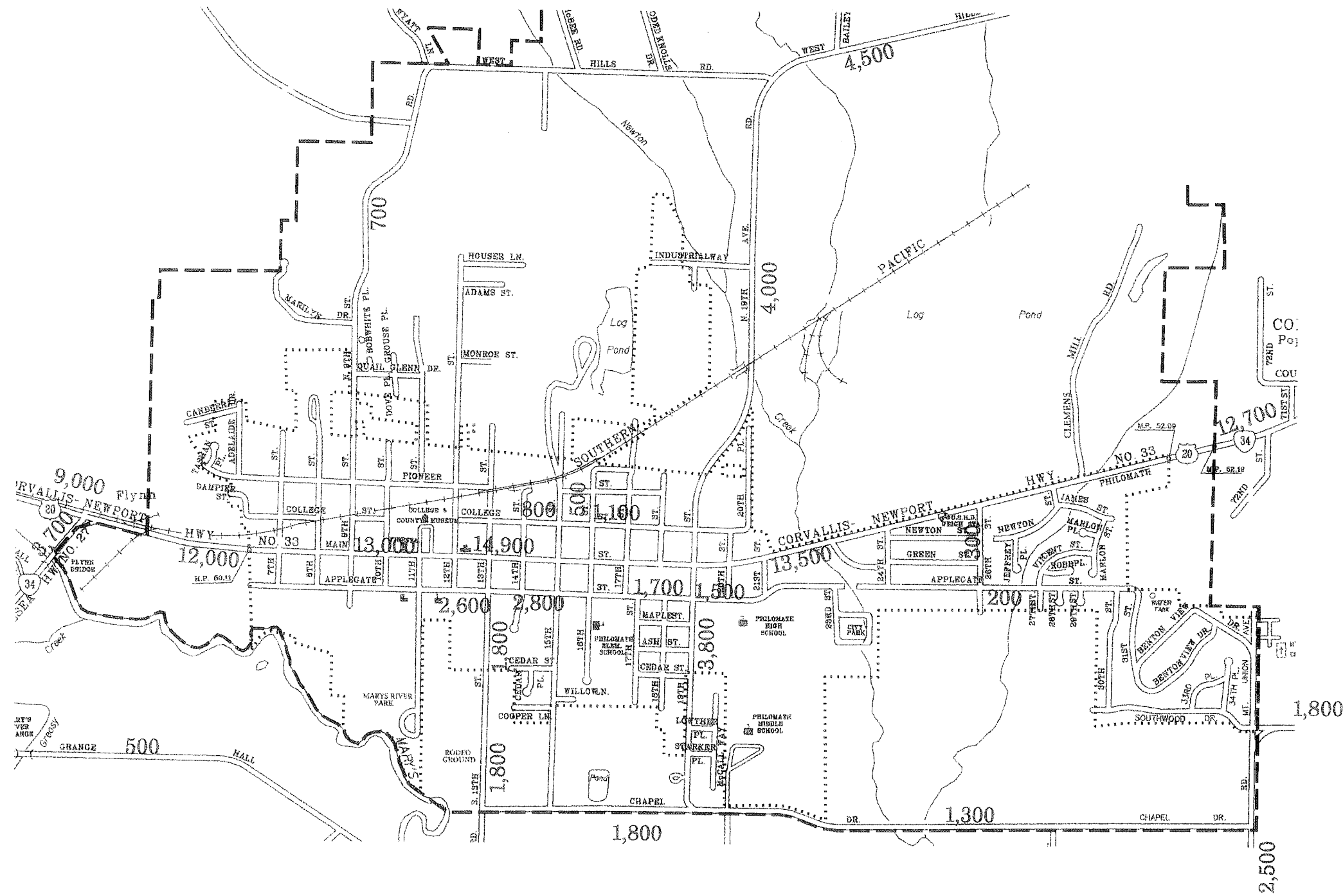

ODOT0254/FIG4-1.DGN/TNT/06-16-98

FIGURE 4-1

1996 ADT Volumes



(NOT TO SCALE)

LEGEND:

- URBAN GROWTH BOUNDARY
- CITY LIMITS
- 450 WESTBOUND VOLUME
- 500 EASTBOUND VOLUME
- 450 SOUTHBOUND VOLUME
- 500 NORTHBOUND VOLUME

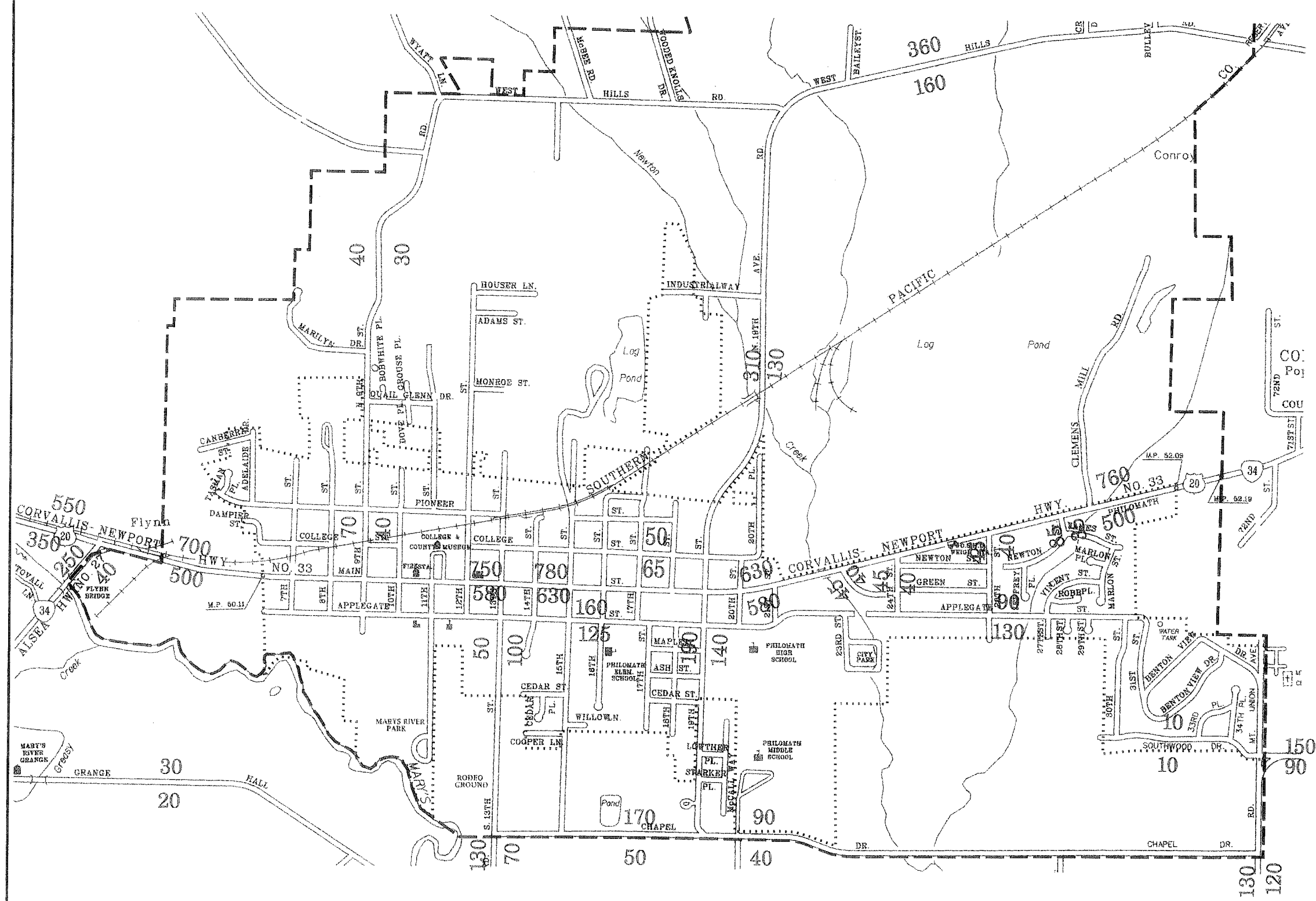

ODOT0254/FIG4-3.DGN/TNT/06-16-98

FIGURE 4-3

1996 PM Peak Hour Traffic Volumes



(NOT TO SCALE)

LEGEND:

- U.G.B. LINE
- CITY LIMITS
- █ EXISTING TRUCK ROUTE
- (470) ADT
- 19 PM Peak Hour
- 39

FIGURE 4-4

Existing Truck Route System & Truck Volumes

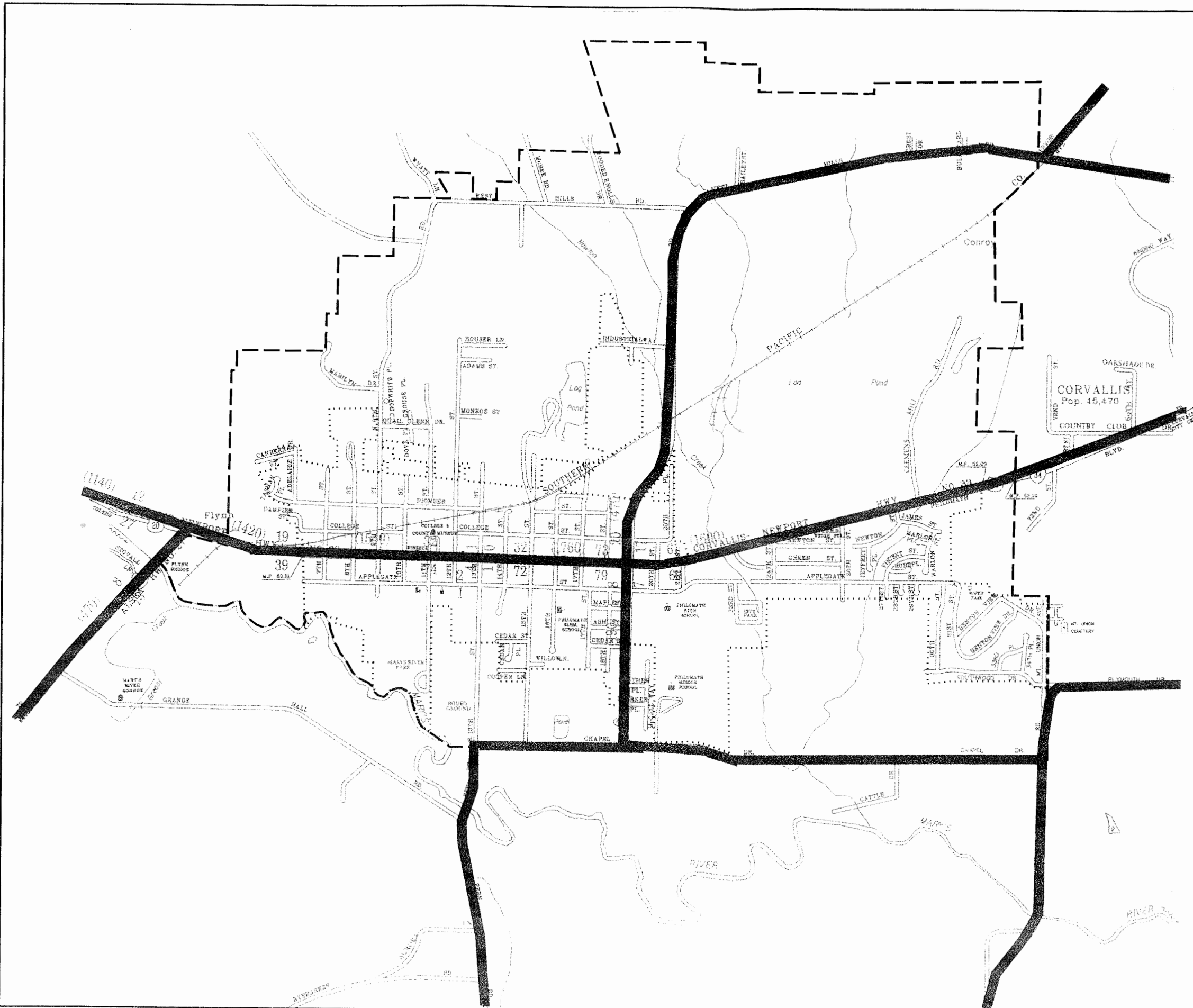

CHAPTER 5: TRAVEL FORECASTS

DEFINITION

Travel demand forecasting is a method used to predict future traffic conditions in an area, city, or region. This is done to identify where problems will exist in the future along streets and at intersections. One tool used to perform a travel demand forecast is a traffic model.

TRAFFIC MODEL

A travel forecasting model was developed in 1991 for the City of Corvallis and the surrounding metropolitan area. Philomath was included in this model because it was estimated that the Corvallis/Philomath area will be designated as an urban area by the year 2000. A computer modeling program known as EMME/2 was used to simulate traffic on the regional street network for existing (1991) and future year (2016) conditions. This traffic model was used as a tool in projecting traffic volumes for various street improvement alternatives identified in the Philomath TSP.

Two time periods were analyzed in the original model: the average daily traffic (ADT) and the PM peak hour. Average daily traffic includes the total traffic over a 24-hour period for a typical weekday. The PM peak hour is a one-hour period that usually occurs between 4:00 and 6:00 p.m. for an average weekday. This is also the time period when traffic volumes on the local street system are usually the highest. The PM peak hour was selected as the critical period for analysis in the Philomath TSP.

It should be noted that the City of Corvallis/Philomath area EMME/2 traffic model has been updated twice since its inception. The first update was performed in December 1994,¹ by DKS Associates, Inc. The second update, which included only minor changes in land uses in Corvallis, was performed in 1996 by Kittelson and Associates, Inc. The second update to the Corvallis/Philomath EMME/2 model (containing the most current information) was used to aid in the Philomath travel forecast. A check was made with ODOT, the City of Corvallis, and Kittelson and Associates, Inc. to ensure the integrity of the most recent model update. This version of the model was compared to existing traffic and adjusted to provide data to closely match the existing traffic (calibrated).

Information on the development of this model such as a description of the traffic modeling process can be found in the *Corvallis Model Update Travel Model User's Guide*, prepared for ODOT and the City of Corvallis by DKS Associates, Inc., December 1994.

FUTURE TRAFFIC FORECASTS

Once the Corvallis/Philomath traffic model was developed to represent the 1991 traffic conditions for the existing population, future traffic volumes were estimated based on the population increasing to 62,500 in the region including approximately 5,200 in Philomath. It is expected that the population will reach this number by the year 2016, which is also the forecast year selected in the Philomath TSP.

Traffic for the year 2016 was first assigned in the EMME/2 model to the existing major street system to determine which portions of the Philomath street system would be deficient within the next 20 years. This was established as the No-Build scenario. The model was then used to evaluate the effects of alternative roadway configurations on traffic assignment such as the potential one-way couplet in the downtown area. These alternatives are described in Chapter 6.

NO-BUILD SCENARIO

The No-Build scenario establishes the baseline for all other analyses. This scenario assumes that no major changes will be made to the existing transportation system during the next 20 years. By comparing the future traffic demand with the unchanged transportation system, we can determine where future traffic problems are likely to occur.

Traffic Volumes

The results of the "No-Build" PM peak hour forecast traffic for the year 2016 are shown in Figure 5-1. It is important to note that most of the PM peak hour volumes illustrated in this figure were taken directly from the 2016 "No-Build" EMME/2 model run output. It was explained earlier in this report (Existing Traffic Volumes - Chapter 4) that in most areas the 1991 EMME/2 model traffic volumes resembled 1996 volumes. The 2016 traffic projections essentially represent existing 1996 volumes combined with future additional traffic from increased population and employment over the next 20 years. The "No Build" year 2016 Average Daily Traffic volumes are shown in Figure 5-2.

Two locations were manually adjusted to reflect more accurate traffic projections: US Highway 20 west of the Alsea Highway intersection and Highway 20/34 east of the Alsea Highway intersection. It was explained earlier in this report how the existing 1996 volumes in these two areas were adjusted. Future traffic at these two locations was estimated by applying future additional traffic to the adjusted 1996 volumes.

Changes in Traffic Patterns

Without changes to the existing street system, delays are expected to become exceedingly long during the PM peak hour along Highway 20/34 through Philomath, particularly between the Alsea Highway intersection and 19th Street. The model results show that traffic volumes between the Alsea Highway intersection and 19th Street will increase over 50% by the year 2016. As a result, drivers will use alternative routes, which parallel Highway 20/34 (Main Street), in an attempt to bypass as much of the downtown area as possible. Soon routes like Green Road to 19th Street, West Hills Road to 9th Street, and Chapel Drive to Fern Road/13th Street will experience significantly higher traffic volumes.

Future Traffic Operations

Once future traffic volumes were projected, the operations of key streets and intersections were analyzed.

Streets

Based on the EMME/2 traffic model, increased traffic along Highway 20/34, between the Alsea Highway and 19th Street, are estimated to push PM peak hour v/c ratios well over 1.0 (over capacity) in many areas for westbound traffic and just over 1.0 for eastbound traffic. A v/c ratio over 1.0 indicates the roadway's capacity has been exceeded by traffic demand. This also means that traffic would be expected to be stop and go during the peak hours with considerable delay. In the area between the Alsea Highway and 9th Street intersections, the v/c ratio is estimated to reach around 1.52 for westbound traffic. Further to the east between 9th Street and 13th Street, v/c ratios are expected to reach 1.28 for westbound traffic. Between 13th Street and 19th Street, v/c ratios are

expected to be just over 1.0 for both directions of travel. With a current v/c close to 1.0 and LOS of F for this area, operations will deteriorate more as traffic volumes increase in the future.

With most of the additional traffic, between the current and future year, projected to use the other alternative parallel routes previously mentioned, additional increases in traffic along Highway 20/34 east of 19th Street, will be minimal. However, v/c ratios are still projected to reach just under 1.0 (capacity) in this area east of 19th Street.

Intersections

Future traffic operations at the two key signalized intersections and five key unsignalized intersections are described in Tables 5-1 and 5-2 along with their current operations.

For the five intersections counted in April 1998, future traffic volumes were determined by applying increased traffic between the 1991 model, which in most areas of Philomath represents current (1996) traffic conditions, and the 2016 "No-Build" scenario added to existing traffic volumes. Adding increased traffic to actual existing traffic reflects a more realistic estimate. As for the remaining two intersections not counted, traffic operations were determined directly from year 2016 model output.

**TABLE 5-1
YEAR 2016 NO-BUILD
LEVEL OF SERVICE AND SATURATION VALUES (X)
AT SELECTED SIGNALIZED INTERSECTIONS**

Location	Current LOS (Sat. Value X)	2016 No-Build LOS (Sat. Value X)
Hwy 20/34 (Main Street)		
at 13th Street	B (59%)	D-E (84%)
at 19th Street	C (63%)	E (95%)

Results indicate a deterioration from LOS B to D/E at the intersection of Main Street and 13th Street, and a deterioration from LOS C to E at Main Street and 19th Street, which exceeds the minimum requirement of LOS D along the highway¹.

¹ This is the minimum level of service standard from the 1991 Oregon Highway Plan assuming that the area is part of a Corvallis/Philomath Metropolitan Planning Organization (MPO).

TABLE 5-2
2016 NO-BUILD LEVEL OF SERVICE
AT SELECTED UNSIGNALIZED INTERSECTIONS

Location	Traffic Movement	Current LOS	2016 No-Build LOS
Hwy 20 at Hwy 34	Northbound; Left	C	E*
	Northbound; Right	A	C
	Westbound; Left	A	D
Main Street at 9th Street	Eastbound; Left	A	D
	Westbound; Left	A	A
	Southbound; All	D	F*
	Northbound; All	D	F*
Main Street at 26th Street	Westbound; Left	A	A
	Northbound; All	D	D
Applegate Street at 13th Street	All Movements	A	A
Applegate Street at 19th Street	All Movements	A	A

*Below minimal operating standard

Applying the same minimal operating standard of LOS D, two unsignalized intersections are expected to fall below this standard: Highway 20/34 at OR Highway 34 and Main Street at 9th Street.

The 2016 No-Build (no transportation system improvements) option results in a large increase in traffic on local streets and additional delay on Highway 20/34 in Philomath. Highway 20/34 east of 19th Street has a small increase in PM peak hour traffic while the PM peak hour traffic on West Hills Road increases approximately three times. Minimum standards for acceptable levels of service are expected to be exceeded as previously shown. Major transportation system improvements are necessary to mitigate the future expected deficiencies, which would result from the No-Build scenario in Philomath. The next Chapter includes evaluations of the improvement options.



(NOT TO SCALE)

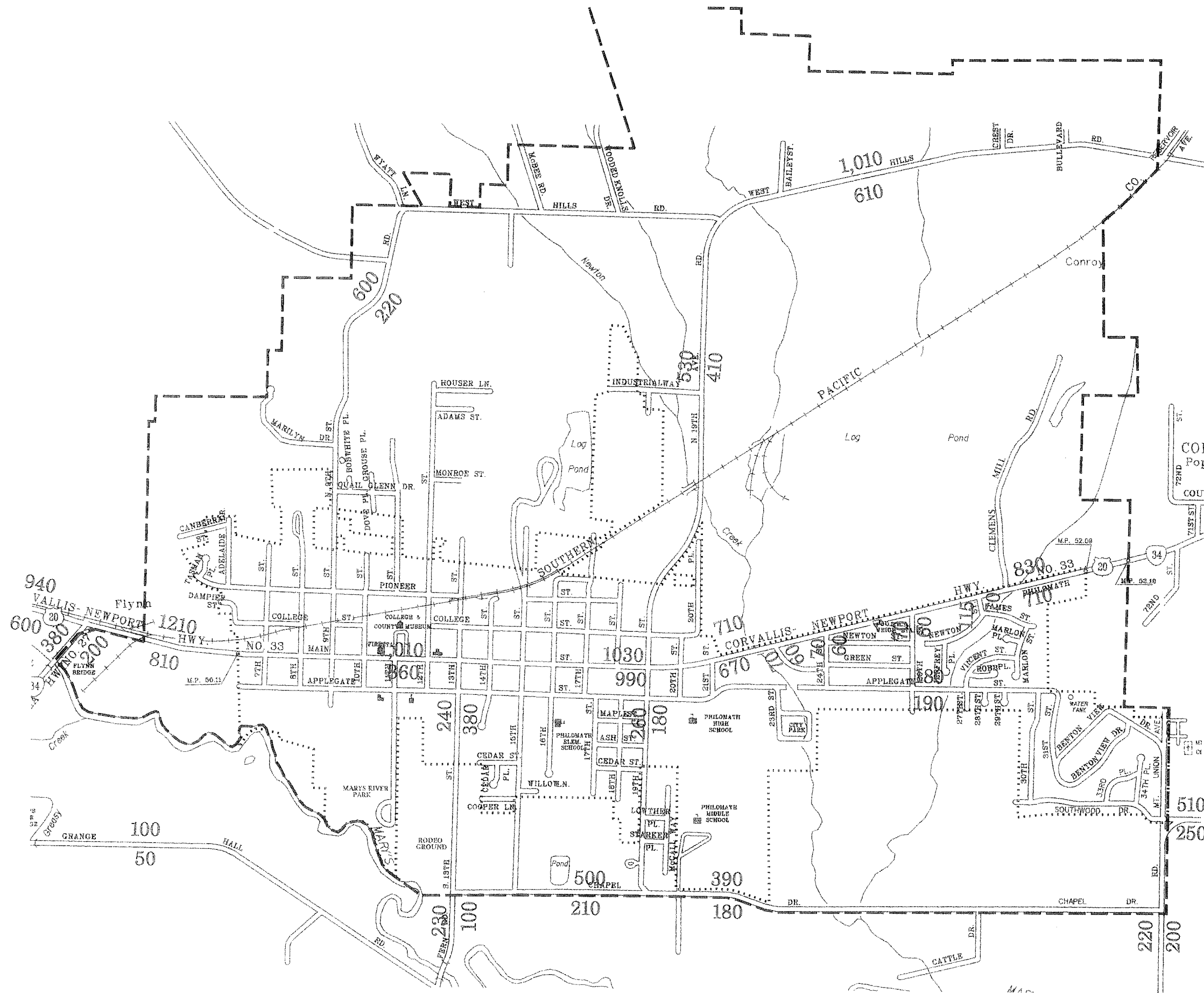

LEGEND:

- URBAN GROWTH BOUNDARY
- CITY LIMITS
- 450 WESTBOUND VOLUME
- 450 EASTBOUND VOLUME
- 450 SOUTHBOUND VOLUME
- 450 NORTHBOUND VOLUME

FIGURE 5-1

**2016 No Build PM
Peak Hour Traffic Volumes**



(NOT TO SCALE)

LEGEND:

--- URBAN GROWTH BOUNDARY

..... CITY LIMITS

4,200 2016 ADT VOLUMES

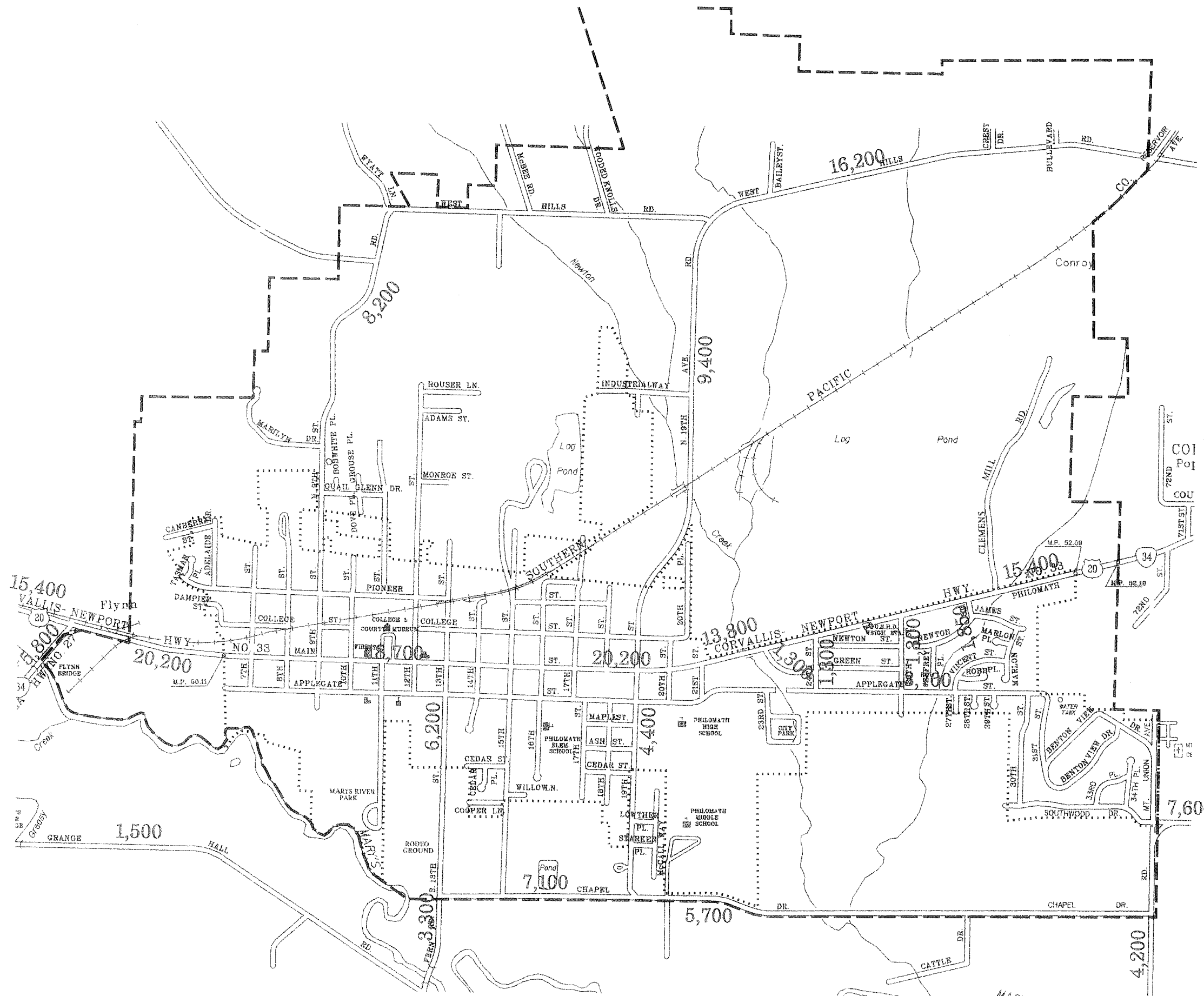

FIGURE 5-2

2016 No Build Average Daily Traffic Volumes

000T0254/FIG5-2.DGN/TNT/08-20-98

CHAPTER 6: EVALUATION OF TRANSPORTATION SYSTEM IMPROVEMENT OPTIONS

This chapter of the Philomath TSP provides an evaluation of identified potential transportation system improvement options for the Philomath area over the 20-year planning period. The evaluation includes an analysis of land use and transportation demand management strategies, transportation system management options, major street improvement projects, new bicycle and pedestrian facilities, and potential projects for other modes of travel in the city including transit service, and rail, air, water, and pipeline facilities. The evaluation for a future No-Build option is summarized in Chapter 5. A summary listing of the options discussed in this chapter and the recommendation for each option is included at the end of the chapter.

The transportation needs and alternatives for Philomath were identified with the help of the public through an open house and the Transportation and Traffic Safety Commission (TTSC), and address the concerns specified in the goals and objectives of Chapter 2. Except for the No-Build option the transportation improvement options considered are described and discussed with the evaluations later in this chapter.

Based on the analysis of all transportation system improvements, a detailed list of improvements to be incorporated into the TSP is recommended in Chapter 7. As discussed in the remaining sections of this chapter, not all of the considered improvement options were recommended. These recommendations were based on public opinion, environmental considerations, project costs, and benefits relative to traffic operations, the transportation system, and community livability including land use.

EVALUATION CRITERIA

The evaluation of all potential transportation improvements was based on a quantitative analysis of traffic projections and street system operations, and a qualitative review of safety, environmental, socioeconomic, and land use impacts, as well as estimated project costs.

The quantitative analysis of each improvement considered different factors such as overall traffic volume flows, changes in travel patterns, and the impact to operations of critical streets and intersections.

In addition to the quantitative traffic analysis, three factors were evaluated qualitatively: 1) safety; 2) environmental factors such as historic impacts, wetlands impacts and threatened or endangered species impacts; and 3) socioeconomic and land use impacts such as right-of-way (ROW) requirements, community livability, existing land use and impacts to any adjacent homes or businesses. The existing land use and wetlands distribution maps are shown in Figures 1-1 and 1-2 in Chapter 1.

The final factor in the evaluation of the potential transportation improvements was project cost. Costs were estimated in 1998 dollars based on the project limits of each potential transportation system improvement. A matrix was prepared and included later in this chapter showing positive and negative factors for the major transportation infrastructure alternatives.

EVALUATION OF POTENTIAL TRANSPORTATION IMPROVEMENT OPTIONS

Land Use Strategy - Revise Zoning and Development Codes

Overview: This strategy could result in amending the City of Philomath Comprehensive Plan and zoning and development codes to permit mixed-use developments and increase density in certain areas. Specific amendments include allowing neighborhood commercial uses within residential zones and allowing residential uses within commercial zones. The existing land use is shown in Figure 1. in Chapter 1.

Traffic Projections: Such code amendments can encourage residents to walk and bicycle throughout the community by providing shorter travel distances between land uses. A shift in travel mode would reduce reliance on the automobile, a goal of the state Transportation Planning Rule (TPR).

Operations: These changes combined with the construction of new street, bicycle and pedestrian facilities can help reduce traffic congestion and improve the livability in Philomath.

Impacts: Maintaining the livability of the community encourages new residents and businesses to locate in Philomath, helping to maintain the area's economic vitality.

Costs: No direct costs are associated with making comprehensive plan policy zoning code amendments.

Recommendations: Permitting mixed-use developments and increased density is encouraged within the city limits of Philomath. Appropriate changes in land use should be considered as part of any major street improvement project, which makes substantial changes in traffic routing. Implementation of these measures and changes to the comprehensive plan and zoning ordinances should be at the discretion of city officials.

Transportation Demand Management Strategy

The TPR recommends that a city evaluate Transportation Demand Management (TDM) measures as part of their TSP. TDM strategies are intended to change the demand on the transportation system by providing facilities for alternative modes of transportation, implementing carpooling programs, and applying other transportation measures such as staggered work schedules. Generally, these strategies would be more effective in larger cities but some strategies can still be useful in cities the size of Philomath. Provisions for alternative modes of transportation such as sidewalks for pedestrians and bicycle lanes for bicyclists will be beneficial. Even though carpool lots were discussed by the TTSC, it does not appear that the expected use is high enough to justify carpool lot costs at the present time. Other TDM measures such as staggered work hours or carpools are not expected to be effective enough to justify the costs of implementation within the City of Philomath due to the small business, employer and population sizes.

However there are efforts to implement TDM measures for Corvallis. With major employers such as Oregon State University and Hewlett Packard employees from Philomath could be involved in Corvallis TDM implementation. The Cascades West Council of Governments is working on implementing TDM projects for the Corvallis area.

Impacts: Providing adequate pedestrian/bicycle facilities will increase the livability and transportation safety in Philomath.

Costs: The estimated construction cost for concrete sidewalks and asphalt bicycle lanes on both sides of a street is approximately \$100 per linear foot. This cost does not include right-of-way or drainage costs that may need to be included. Cost estimates were not made for the carpooling and Corvallis TDM strategies.

Recommendation: Implementing TDM would provide needed facilities for pedestrians and bicyclists, improve safety and enhance quality of life in Philomath. Therefore TDM strategies as previously discussed are recommended.

Transportation System Management Options

Transportation System Management (TSM) options are designed to increase the capacity, or improve access and safety, along roadways and at intersections while maintaining and preserving the existing transportation system. TSM improvements usually include smaller scale or smaller cost projects such as improved traffic control at an intersection but may also include larger projects to improve management of the transportation system.

The TSM options for the Philomath area were identified from the TTSC and public meetings, as well as the analyses of existing and future No-Build traffic conditions (Chapters 3, 4 and 5). The locations of the TSM options are illustrated in Figure 6-1 with complete descriptions and evaluations found later in this chapter.

1. Install traffic signal at the intersection of US Highway 20 and OR Highway 34.
2. Install traffic signal at the intersection of Main Street and 9th Street.
3. Install traffic signal at the intersection of Main Street and 26th Street.
4. Bridge and intersection improvements along Grange Hall Road.
5. Truck route improvements:
 - a. Grange Hall Road (options 4 above and 7c below).
 - b. 13th Street – Main Street to Chapel Drive.
6. Access improvements for Clemens Mill Road and Newton Street along Highway 20/34.
7. Extend Newton Street to 26th Street.
8. Street overlays for poor conditioned roads:
 - a. Highway 20/34 - West city limits to Newton Creek Bridge.
 - b. College Street - 12th Street to 20th Street.
 - c. Grange Hall Road - Alsea Highway to Fern Road.
 - d. Mt. Union Avenue - Benton View Drive to Plymouth Drive.
9. Improved street signing in the city.

It is important to note that several TSM projects interrelate with other Major Street Improvement Options as indicated in each evaluation.

Major Street Improvement Options

The street improvements listed in this section are larger scale projects designed to dramatically enhance the local street system in Philomath. They address specific major capacity, operations, and accessibility issues that currently exist or are expected to exist in the future.

The following list includes the major street improvement options considered. Each project has been numbered in consecutive order after the TSM options. Options 10, 11 and 12 are illustrated in Figure 6-2, with options 13 through 17 illustrated in Figure 6-3.

10. Improve College Street, Applegate Street and Main Street maintaining two way traffic.
11. Establish a one-way couplet along Highway 20/34 using College Street and or Applegate Street.
 - a. College/Main/Applegate one-way couplet (between the railroad crossing and Green Street)
 - b. Main/applegate one-way couplet (between the railroad crossing and Green Street)
 - b. One-way couplet with additional capacity improvements
 - c. Extended one-way couplet to the west (west of Alsea Highway to Green Street)
12. Widen Highway 20/34 to five lanes (between railroad crossing and Green Street).
13. Bypass Option - extend West Hills Road to the US Highway 20/Alsea Highway intersection.
14. Extend Applegate Street over Newton Creek (Newton Creek Bridge).
15. Extend 13th Street and construct a new road between Industrial Way and 13th Street
16. Construct new roads connecting 26th Street to West Hills Road and Chapel Drive.
17. Construct new roads connecting 72nd Street to West Hills Road and Plymouth Drive (Bellfountain Extension).

The following table, which was presented at the second Open House, summarized the positive and negative considerations for the No Build scenario described in Chapter 5 and the major Highway 20/34 Improvement Options 10, 11 and 12, described in more detail later in this Chapter.

**TABLE 6-1
MAJOR HIGHWAY IMPROVEMENT ALTERNATIVES**

TRANSPORTATION IMPROVEMENT CHOICE	EST. COSTS \$Million *	EST. YEAR 2016 LEVEL OF SERVICE	IDENTIFIED POSITIVE CONSIDERATIONS	IDENTIFIED NEGATIVE CONSIDERATIONS
No Build: Maintains the highway through most of town as a 3-lane facility	\$0	F	<ul style="list-style-type: none"> + Maintains existing features + No additional cost + Continues two-way traffic on all streets 	<ul style="list-style-type: none"> - Doesn't address congestion - May not be acceptable by stakeholders - US HW 20/34 is a significant freight route; this option would increase travel time for freight movement - Doesn't address bicycle or pedestrian needs as well as other alternatives - Truck traffic would continue through downtown - Increases traffic on 9th Street and West Hills
College, Main, Applegate Two-way streets (Improvement Option 10)	\$4.6***	E or better	<ul style="list-style-type: none"> + Cost less than couplet and five-lane option + Some traffic still routed by all businesses + Continues two-way traffic on all streets + This option fits as Phase 1 of option 11A 	<ul style="list-style-type: none"> - Increases traffic on College and Applegate streets by schools and residences while decreasing traffic by most businesses - Level of service will not be acceptable without major intersection improvement at the west end of Applegate
Applegate/College/Main St. Couplet Alignment (Improvement Option 11A)	\$10.5*	D or better **	<ul style="list-style-type: none"> + Improves traffic flows through community + Doesn't directly impact schools + Consistent with City's Comprehensive Plan + Would allow the City to expand business district along College Ave. + There is adequate road right of way (ROW) width except at crossovers + This couplet option was identified as a "preferred" option in 1992 and is in the City's comprehensive plan + Allows for more accesses and traffic signals + Easier to cross for pedestrians, bicycles and vehicles + Allows for a townsquare development if desired + Doesn't directly impact schools 	<ul style="list-style-type: none"> - Proposed crossover near 14th - 15th streets would require property acquisition and may require relocation of a business and demolition or moving 3 to 5 houses - Would require a bridge crossing for College Street to connect back into the highway (environmental impacts?) - Residents along College Street would have to deal with increased traffic, including trucks - At least two blocks in the downtown would not longer have highway frontage - West-bound through traffic would be on College Street rather than on Main St., which some downtown business owners have expressed objections to - May have environmental impacts on stream natural areas
Couplet Alignment (Improvement Option 11B)		**	<ul style="list-style-type: none"> + Requires two less cross-overs + There is adequate ROW except at crossover + Would not appear to displace any residences or businesses + Keeps west-bound traffic moving through the downtown, which some downtown business owners strongly prefer + Allow for accesses and traffic signals + Easier to cross for pedestrian, bicycles and vehicles 	<ul style="list-style-type: none"> - leg of the couplet would pass by the school - May have environmental impacts on stream/natural area - Residents along Applegate St. would have to deal with increased traffic, including trucks - Impacts schools
Expanding Main Street to Five Lanes (Improvement Option 12)	\$14*	D or better **	<ul style="list-style-type: none"> + Keeps tourist traffic moving both east and west through downtown + Does not require any crossovers + Doesn't directly impact schools + Doesn't add traffic on residential streets 	<ul style="list-style-type: none"> - There is insufficient width to put in this type of facility through downtown without building demolition - Five-lane roadways are not pedestrian-friendly, with long crossing distances and delays - Extensive right-of-way required, including building demolitions through the Central Business District - Less traffic signals and access allowed

* Needed highway 20/34 widening east and west from these projects are estimated to cost \$4.4 Million.

** (This is the current standard for metropolitan areas) It is planned that Philomath will be part of a metropolitan area before 2016

*** This doesn't include crossovers



(NOT TO SCALE)

LEGEND:

- U.G.B. LINE
- CITY LIMITS
- ① STREET OR INTERSECTION IMPROVEMENT OPTION NUMBER
- PROJECT LOCATION FOR STREET OR INTERSECTION IMPROVEMENT

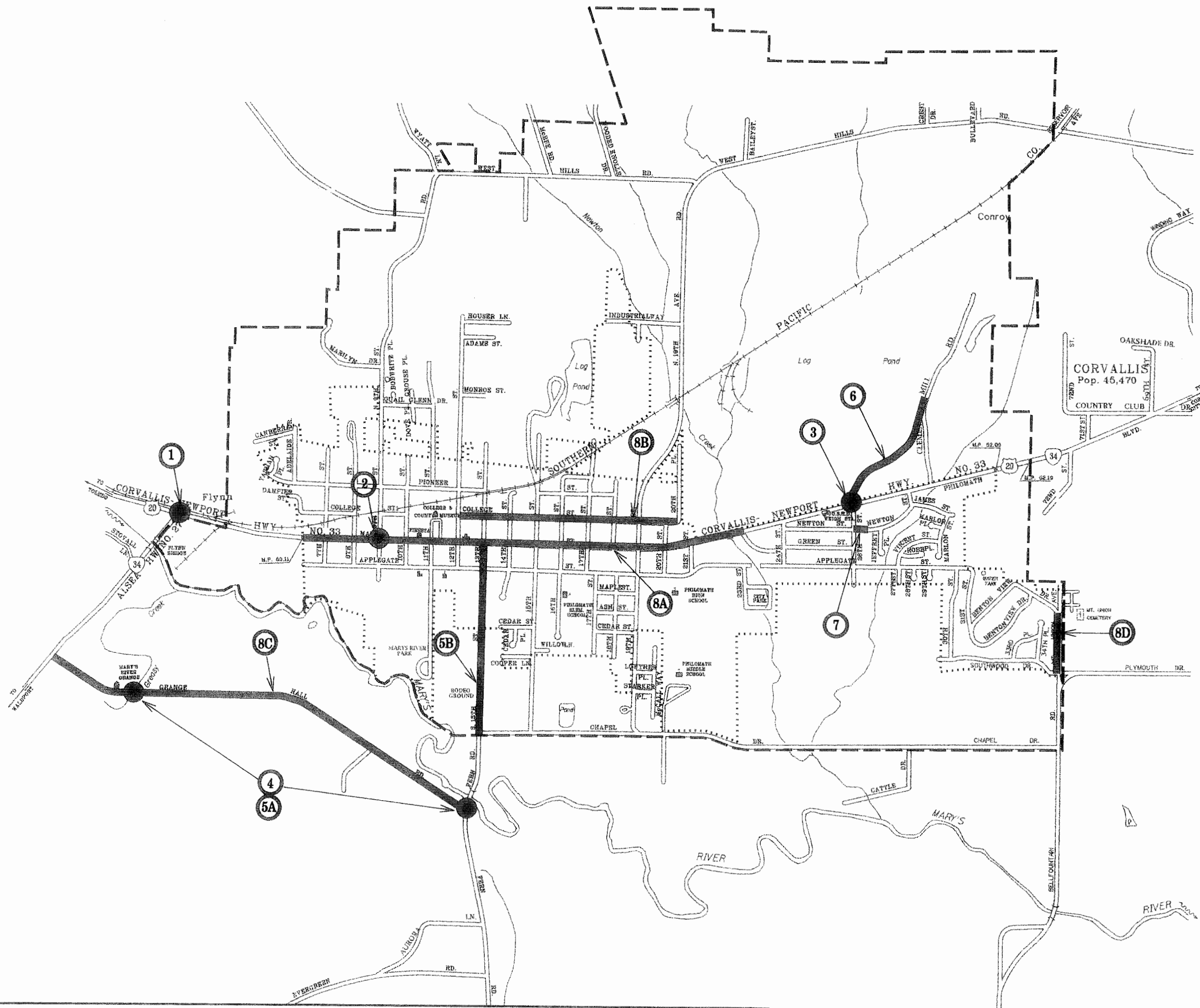

ODOT0254/FIG6-1.DGN/TNT/07-08-98

FIGURE 6-1

TSM Improvement Options

ODOT0254/FIG6-3.DGN/BJD/06-30-98

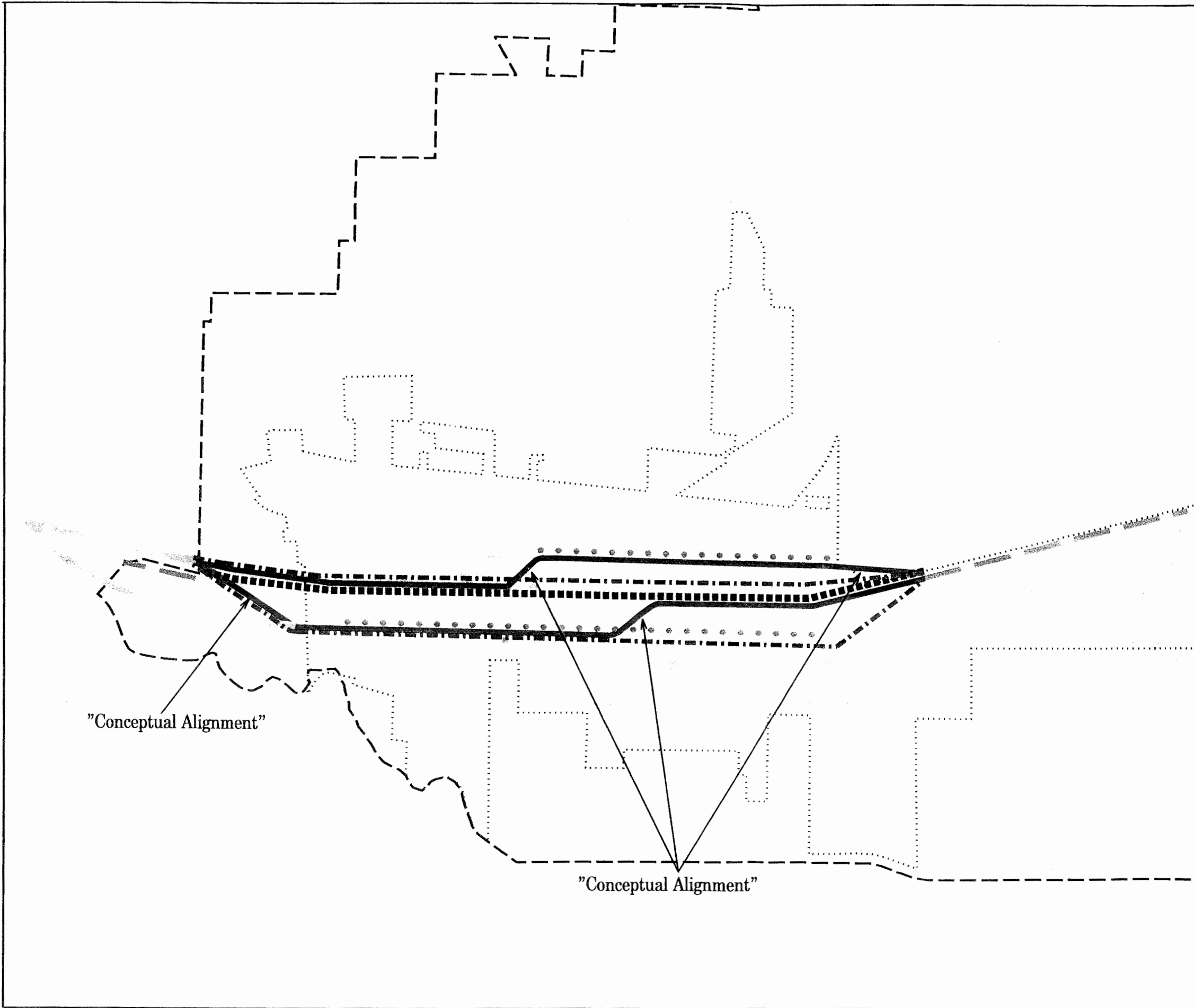

(NOT TO SCALE)

LEGEND:

- U.G.B. LINE
- CITY LIMITS

OPTION

- 10- TWO-WAY STREETS
- 11A-ONE-WAY COUPLET (COLLEGE/APPLEGATE)
- · - · - 11B-ONE-WAY COUPLET (MAIN/APPLEGATE)
- ===== 11C-ONE-WAY COUPLET WITH ADD'L CAPACITY IMPROVEMENTS
- ===== 11D-EXTENDED ONE-WAY COUPLET
- 12- WIDEN MAIN ST. TO FIVE LANES

FIGURE 6-2

Major Street Improvement Options - Highway 20 /34

ODOT0254/FIG6-4.DGN/TNT/08-20-98

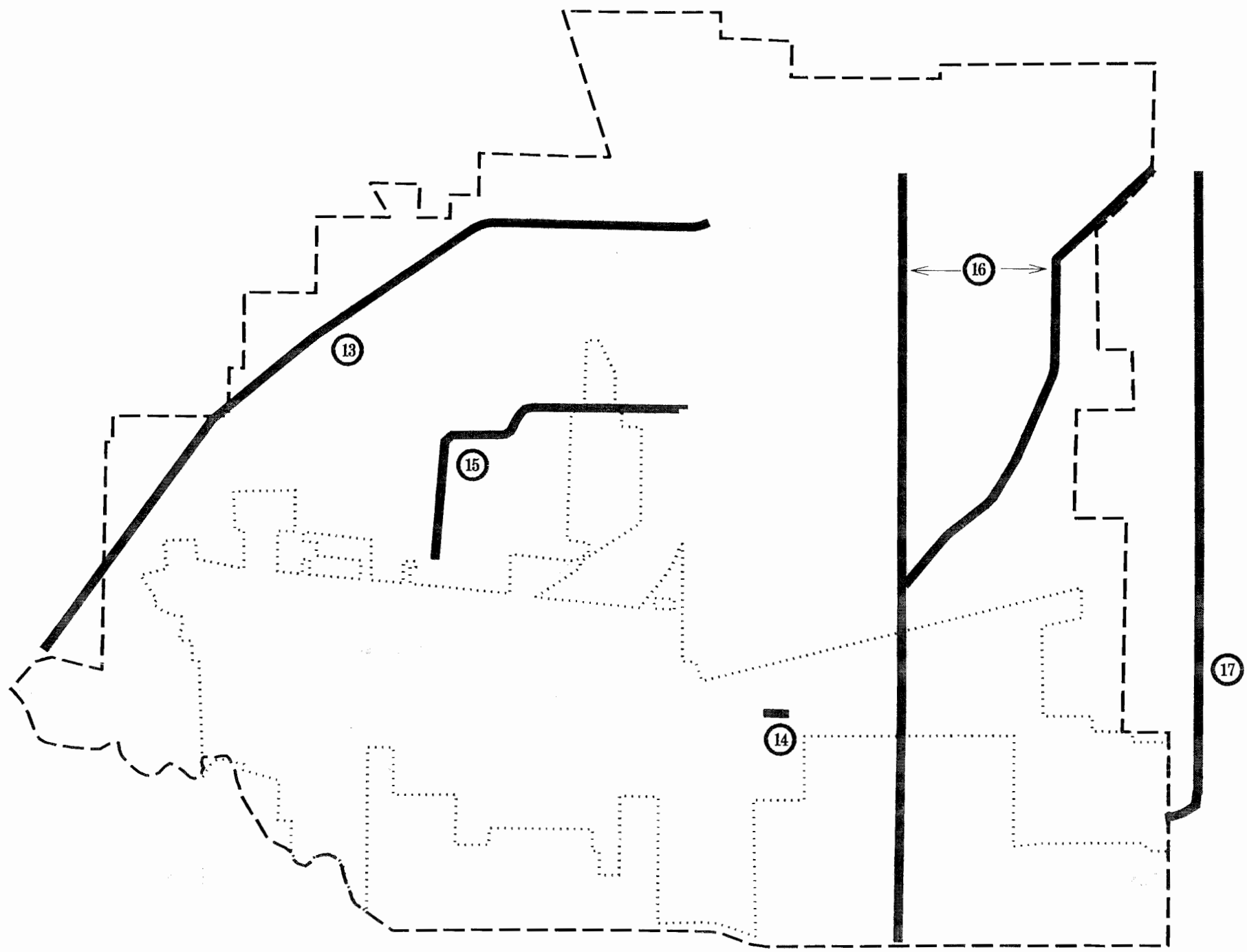

(NOT TO SCALE)

LEGEND:

- U.G.B. LINE
- CITY LIMITS
- ① NEW STREET CONSTRUCTION OPTION NUMBER
- PROJECT LOCATION FOR STREET CONSTRUCTION

FIGURE 6-3

Potential New Street Construction Options

The following Table 6-2 summarized the recommendations for all of the project improvement options. Detailed discussions of the project improvement options evaluations follow the table.

**TABLE 6-2
SUMMARIZED RECOMMENDATIONS
FOR ALL PROJECT IMPROVEMENT OPTIONS**

Option	Description	Proj. No.	Recommendation
	Revise Zoning and Development Codes		Implement as transportation system change opportunities occur.
TDM Strategy			
	None evaluated at this time.		Implement as opportunities occur.
TSM Options			
1	Install Traffic Signal at Intersection of US HIGHWAY 20 and OR 34.	1.	Implement as a long-range project.
2	Install Traffic Signal at the Intersection of Main St. at 9th St..	2.	Implement as part of Option 11C.
3	Install Traffic Signal at the Intersection of Main St. at 26th St..	3.	Implement as a long-range project (after or part of Option 6).
4	Bridge Improvement on Grange Hall Rd. (Greasy Creek Bridge)	4.	Implement as a short-range project (Benton County TSP project).
5	Truck Route Improvements.	5A. 5B.	Implement Option 5A as a short-range project. Implement Option 5B as an intermediate-range project.
6	Access Improvements for Clemens Mill Rd. and Newton St. along Highway 20/34.	10.	Implement Option 6 as a long-range project.
7	Extend (connect) Newton Street to 26 th Street	7.	Implement Option 7 as a short-range project.
8	Street Overlays For Poor Pavement Condition rated Roads.	8A. 8B. 8C. 8D.	Implement Option 8A as an intermediate-range project. Implement Option 8B as part of Project 10. Implement Option 8C as a intermediate-range project. Implement Option 8D as a short-range project.
9	Improved street signing in the city.	9.	Implement as a short-term project.
Major Street Improvement Options			
10	College/Main/Applegate Two-Way Streets	10.	Implement as a short-term project.
11	Establish a One-Way Couplet Along Highway 20/34 Using College St. and Applegate St.	11A. 11B. 11C. 11D.	Implement project 11A as an intermediate-range project. Project 11B is not recommended. Implement project 11C as an intermediate-range project. Project 11D is not recommended.
12	Widen Highway 20/34 to Five Lanes (Railroad Crossing to Green St.).	12.	Not recommended.
13	Bypass Option- Extend West Hills Rd. to the US Highway 20/Aalsea Highway Intersection.	13.	Identify as a potential project occurring beyond the 20-year planning horizon.
14	Extend Applegate St. over Newton Creek.	14.	Implement as a short-range project.

TABLE 6-2, Cont.
SUMMARIZED RECOMMENDATIONS
FOR ALL PROJECT IMPROVEMENT OPTIONS

Option	Description	Proj. No.	Recommendation
15	Construct a New Road Between Industrial Way and 13th St.	15.	Identify as a potential project dependent on development of adjacent parcels, probably occurring beyond the 20-year planning horizon.
16	Construct New Roads Connecting 26th St. to West Hills Rd. and Chapel Dr.	1.	Identify as potential project dependent on development of adjacent parcels, probably occurring beyond the 20-year planning horizon of this TSP.
17	Construct New Roads Connecting 72nd St. to West Hills Rd. and Plymouth Dr. (Bellfountain extension).	2.	Identify as a potential project dependent on development of adjacent parcels, probably occurring beyond the 20-year planning horizon of this TSP.
Bicycle Improvement Options			
	Add bike lanes along 13th St. extension to 19th St. Add bike lanes to US HIGHWAY 20/OR 34 along couplet alignment. Add bike lanes along 72nd St. (Bellfountain) extension. Add bike lanes along West Hills Rd. extension. Add bike lanes along 26th St. extension.	B8.	Develop in conjunction with project #15 above, probably occurring beyond the 20-year planning horizon. Implement in conjunction with project #11 above as an intermediate-range project. Develop in conjunction with project #16 above, probably occurring beyond the 20-year planning horizon. Develop in conjunction with project #12 above, probably occurring beyond the 20-year planning horizon. Develop in conjunction with project #15 above, probably occurring beyond the 20-year planning horizon.
B1	Extend bike lanes along S. 19th St. from College St. to Chapel Dr.	B1.	Implement as a short-term project.
B2	Extend route from Plymouth Dr. to central bike path.	B2.	Implement as a short-term project.
B3	Add multi-use paths along Chapel Dr. from 13th to Bellfountain Rd.	B3.	Implement in conjunction with Benton Co. TSP timeline (to be determined), probably occurring as an intermediate-term project.
B4	Add bike lanes along S. 13th St. from Main St. to Chapel Dr.	B4	Implement as an intermediate-term project.
B5	Add bike lanes along Applegate St. from couplet to 26th St.	B5.	Implement in conjunction with project #11A above as an intermediate-term project.
B6	Add bike lanes along N. 9th St. from Main St. to West Hills Rd.		Identify as a potential project in conjunction with development or resurfacing probably occurring beyond the 20-year planning horizon.
B7	Add bike lanes along West Hills Rd. from Wyatt Ln. to 19th St.	B7.	Implement as a long-term project.
Pedestrian Improvement Options			
P1	Develop multi-use path from 13th to Mary's River across rodeo grounds.	P1.	Implement as an intermediate-term project.
P2	Develop multi-use path from Fern Rd. along Mary's River.	P2.	Implement as a long-term project.
P3	Develop multi-use path from West Hills Rd. to Benton Co. Park.		Identify as a potential project, probably occurring beyond the 20-year planning horizon.
P4	Extend central bike path to 19th St.	P4.	Implement in conjunction with project #1 above as a short-term project, alternatively implement in conjunction with project #11A above as an intermediate-term project.
Transit, Rail, Air, Water, and Pipeline Options			
R1	Rail Siding and Spur.	R1.	Implement as a short term project.

Evaluation TSM and Major Street Improvement Options

Option 1. Install Traffic Signal at the Intersection of US Highway 20 and OR Highway 34 (Recommended in 10 - 20 years)

Overview: This project includes the installation of a traffic signal to maintain future acceptable levels of service and also to improve safety. Without a signal, traffic operations for the left-turn movement on the south approach of OR Highway 34 (Aalsea Highway) are expected to deteriorate from a current LOS C to a LOS E by the year 2016. Traffic operations for the left-turn movement from the east approach on Highway 20/34 will also deteriorate from LOS A to LOS D for the same time period. Driver safety will become worse as traffic volumes entering this intersection increase over time and left turns become more difficult.

Under current traffic conditions, this intersection only meets one signal warrant (Warrant 11 – Peak Hour Warrant) and it is not expected that a traffic signal will be required at this intersection until nearly the year 2016. As a result this is currently expected to be a long term project (10 –20 years)

Traffic Projections: With US Highway 20 and OR Highway 34 providing the only primary routes leading west from Corvallis, Albany, and Philomath, traffic flow through this intersection is expected to increase significantly over the next 20 years. The 2016 No-Build scenario indicates that the volume of PM peak hour traffic entering the intersection will increase by 73 percent (514 vehicles) on the east approach, 70 percent (245 vehicles) on the west approach, and 43 percent (59 vehicles) on the south approach.

Operations: Without a signal, future traffic operations at this intersection will reach a LOS E for the northbound left turn and LOS D for the westbound left turn. With a traffic signal, operations for the same movements would improve to LOS A and LOS C to D, respectively. Overall, the intersection is expected to operate at a LOS C to D. However, the delay for the eastbound and westbound through movements, which have the greatest amount of traffic, will increase from installing a signal. Details of the operations analysis at this intersection can be found in Appendix E.

Impacts: As traffic volumes increase over time, left-turn movements will be more difficult to perform as gaps in conflicting traffic will be less prevalent. A future traffic signal when required, would improve safety by controlling conflicting traffic to provide gaps as needed.

Costs: The cost of installing a traffic signal is approximately \$200,000.

Recommendations: A future traffic signal installation is recommended at this intersection. The timing of the installation should be dependent upon several factors: 1) ongoing operations of the northbound left-turn and westbound left-turn movements, 2) ongoing analysis of signal warrants, and 3) implementation of the Major Street Improvement Options 10B, 10C, 11, and 12, where each of these options includes a future traffic signal at this location. It is not expected that the traffic signal will be required until near the year 2016 and this is recommended as long term project when intersection widening is also required on Highway 20.

**Option 2. Install Traffic Signal at the Intersection of Main Street and 9th Street
(Recommend in 5 - 10 years as part of the one-way couplet project 10B)**

Overview: This project includes the installation of a traffic signal to maintain future acceptable levels of service and also to improve safety on the minor approaches to 9th Street. Without a signal, traffic operations for the north and south approaches to 9th Street are expected to deteriorate from a current LOS D to a LOS F by the year 2016. Even with the center left-turn lane along Main Street, traffic operations for the eastbound and westbound left-turn movements will also deteriorate from a LOS A to LOS F because of increased traffic flow in opposing directions.

The signal warrant analysis performed at this intersection for existing traffic conditions indicates only one traffic signal warrant is met (Warrant 11 - Peak Hour Volume). As the total traffic entering this intersection increases, more warrants will be met.

Traffic Projections: Without street improvements, traffic volumes are expected to increase significantly along North 9th Street. As congestion increases along Main Street over the next 20 years, drivers will soon look for alternative routes; one such route being North 9th Street to West Hills Road. The 2016 No-Build scenario indicates PM peak hour traffic volumes at this intersection will increase along North 9th Street by about 245 northbound vehicles and 480 southbound vehicles. A majority of this additional traffic will be vehicles traveling west between 9th Street and Main Street in an effort to avoid the congested downtown area.

Operations: It is estimated that the installation of a traffic signal will only improve the operations from LOS F to LOS E in the future. The LOS for unsignalized and signalized intersection operations is not directly comparable. For the unsignalized intersection the side street through and left turn traffic have lower levels of service that are improved by installing a traffic signal. After the traffic signal is installed the operations for the side street approaches is improved at the expense of lowering the LOS on the main street approaches. Traffic operations cannot be improved to meet the required minimum standard for this intersection without widening because of the capacity limitations created by current lane geometry, particularly for the eastbound and westbound through movements along Main Street where there is only one through lane for both approaches.

Impacts: The installation of a traffic signal at this intersection will provide better access for vehicles on 9th Street but will increase delays along Main Street. Also, the city has closed the street accesses at the railroad crossings located on 8th, 10th, and 12th Street. These crossing closures will shift more traffic onto 9th Street as well as 13th Street.

Costs: The cost of installing a traffic signal is approximately \$200,000.

Recommendations: A traffic signal is not recommended at the present time. However, as the total traffic entering this intersection increases, more warrants will be met and it is expected that a traffic signal will be required.

A traffic signal alone should not be installed at this intersection unless other major street improvement projects, such as Options 10, 11, and 12, are implemented to accommodate future east-west traffic demand in Philomath. Under the No-Build scenario, installing a traffic signal at this intersection would be futile, since the minimum required standard LOS D cannot be reached. However, the LOS would be acceptable if a traffic signal was installed along with either constructing the one-way couplet (Option 10) or widening Main Street to five lanes (Option 11.), or constructing a new connector between West Hills Road and the Alsea Highway (Option 12). A traffic signal at 9th Street with Option 11 would not provide for good two-way traffic progression and may not be acceptable as a result of the impacts from the additional stopping of traffic on Highway 20/34. Traffic LOS operations on the 9th Street approach at this intersection would remain unacceptable in the future without a traffic signal, even with any of these major capacity improvements.

**Option 3. Install Traffic Signal at the Intersection of Main Street and 26th Street
(Recommend in 10 - 20 years)**

Overview: This project includes the installation of a traffic signal to ensure acceptable levels of service in the future and improve safety. Another goal is to make access to and from Highway 20/34 at this location more efficient than the other multiple access points that exist in the vicinity of Green Street, 24th Street, Newton Street and Clemens Mill Road.

Results from a signal warrant analysis revealed that a traffic signal is not warranted under current traffic conditions. However, future traffic volumes may warrant a signal.

Traffic Projections: Traffic projections for the year 2016 indicate a 10 to 20 percent increase in traffic flow during the PM peak hour along Highway 20/34 in the vicinity of 26th Street, with an increase of 60 vph westbound and 100 vph eastbound. Increases over the next 20 years would be much higher along the highway if it were not for the capacity restraints of Highway 20/34. Traffic projections also show a combined increase of 90 vehicles northbound and 114 vehicles southbound during the PM peak hour for those roads intersecting the highway in the area (Green Street, 24th Street, 26th Street, and Newton Street).

Operations: Without a signal, traffic operations are expected to remain unchanged at LOS D at the 26th Street approach and a LOS A for the westbound left-turn from the highway. The analysis of future traffic operations at this intersection was based on two assumptions: 1) no other street improvements will occur in the city and 2) the future increases in traffic accessing and egressing the highway will be spread out over the four roads which intersect the highway from the south.

Although the operations for left-turn maneuvers from the highway at these four intersections are projected to remain at LOS A, the combined effect of cars making these left turns along with stopping westbound through traffic will create additional delays on the highway. A traffic signal with a left-turn storage bay would separate those left-turning vehicles from the through traffic providing more efficient traffic progression.

A traffic signal installed at 26th Street may also help to create platooning of vehicles along the highway as they enter the city and pass through the other two existing signalized intersections on Main Street at 19th Street and 13th Street.

Impacts: A traffic signal installed at 26th Street would have a more positive impact than any of the three other locations in the immediate area. This location would provide efficient circulation of neighborhood traffic, and create safe conditions for pedestrians who need to cross the highway. There would be increased overall delay but the level of accident severity should be decreased.

Costs: The cost of installing a traffic signal and providing the necessary left-turn storage bays is approximately \$300,000.

Recommendation: A future traffic signal installation is recommended at this intersection. The timing of the installation should be dependent upon several factors: 1) ongoing analysis of operations and safety of the northbound left-turn and westbound left-turn movements; 2) ongoing analysis of signal warrants; 3) implementation of Options 10B, 11 and 15, which would attract more traffic along either Highway 20/34 or 26th Street and would necessitate the installation of a traffic signal; 4) implementation of Option 6 which would attract Clemens Mill Road traffic and 4) implementation of Options 12 and 13, which may delay the installation.

Option 4. Bridge and Intersection Improvements Along Grange Hall Road in Benton County (Recommended in 0-5 years)

Overview: This project involves planned structural improvements to one bridge and potential sight distance improvements at one intersection along Grange Hall Road, outside the city limits and the urban growth boundary.

Benton County is planning to make structural improvements at the Greasy Creek Bridge near the western end of Grange Hall Road. Currently, there are weight restrictions posted on this bridge that prevent specific types of trucks with specific payloads from traveling along this road. Posted truck weight restrictions are as follows: three-axle (24 tons), five-axle (37 tons), and six-axle (34 tons). The goal of strengthening this bridge is to allow heavier trucks to access Grange Hall Road. This improvement, in conjunction with integrating Grange Hall Road into a future truck route system, could help to reduce future truck traffic levels along Main Street through Philomath.

The second improvement is to realign a section of Fern Road including its intersection with Grange Hall Road. Currently, there is some sight distance concerns along Fern Road, just south of the bridge over Mary's River. Fern Road has a sharp turn before the bridge crossing and the intersection at Grange Hall Road is just along this turn. Relocating the curve along Fern Road to the south would improve sight distance at the intersection.

Traffic Projections: An additional traffic forecast was performed with the EMME/2 model for the year 2016 with the inclusion of Grange Hall Road.

It should be noted that the 1991 and 2016 No-Build scenarios did not include Grange Hall Road in the major street network of the model. Reasons for not including this road in the model include its present location outside the city limits and urban growth boundary, the streets' classification as a county minor collector street, and the presence of low traffic volumes (currently about 50 vph in each direction).

Results from adding Grange Hall Road indicate a sizable number of vehicles will potentially use this route in the future, particularly during peak travel periods. The model indicates some traffic will be directed away from Highway 20/34 in downtown Philomath, where traffic congestion along the highway is expected to be heavy. It also indicates driver demand will increase along the Plymouth Drive/Chapel Drive route from or to 53rd Street in Corvallis, as these drivers will find a quicker route to US Highway 20 along Grange Hall Road.

Traffic Operations: Traffic operations along critical streets and at key intersections along Highway 20/34 in Philomath will not change as a result of the proposed improvements, relative to the No-Build scenario. The improvements proposed along Grange Hall Road are for allowing truck usage and improving driver safety and not for increasing capacity.

Impacts: The improvements to the Greasy Creek Bridge would allow more trucks to use Grange Hall Road and bypass Main Street downtown. Less trucks in the downtown area would improve community livability and reduce noise levels.

The realignment of the Fern Road and Grange Hall Road intersection would improve safety for drivers.

Costs: The estimated costs, which including design and engineering expenses, are approximately \$620,000 for the bridge improvement and approximately \$200,000 for the intersection realignment, for a total project cost of \$820,000.

Recommendations: The improvement along Fern Road was identified in the draft *Benton County Transportation System Plan*. Implementation of this project and the Greasy Creek Bridge project fall under county jurisdiction,

since the county owns and maintains Grange Hall Road and Fern Road. These improvements would provide an alternative route for trucks and is discussed as part of Option 5A in the following section.

Option 5. Truck Route Improvements (Recommended in 0-10 years)

Overview: Both projects identified here will enable Grange Hall Road and 13th Street to become part of the existing truck route system through the Philomath area.

- A. The first project includes the street improvements identified along Grange Hall Road (Option 4 and 8C). This project is outside the Urban Growth Boundary for Philomath but impacts traffic in Philomath.
- B. The second involves improvements along 13th Street, between Chapel Drive and Main Street. Complete reconstruction of this road is required to provide the structural integrity needed to support heavier truck loads. Also assumed as part of this upgrade are sidewalks and bicycle lanes along the entire length. On-street parking is assumed along both sides of the road between Applegate Street and Main Street.

Traffic Projections: Project A traffic projections were discussed in the previous section for Option 4. Based on the traffic model results it is expected that a number of trucks will use this route as an alternative to Highway 20/34 through the downtown part of Philomath. Project B is also expected to attract truck traffic off from Highway 20/34 to avoid the downtown area between 13th and 19th Streets.

Traffic Operations: Traffic operations levels of service are not expected to change as a result of the truck traffic attracted by projects A and B.

Impacts: Both projects will improve the connectivity of the regional and local truck route system.

Costs:

- A. Grange Hall Road Improvements
(included in the draft Benton County TSP) \$ 820,000
- B. 13th Street Improvements \$2,000,000

Recommendations: These improvement projects are recommended to provide for alternative routing for trucks south of the downtown Philomath area.

Option 6. Access Improvements for Clemens Mill Road and Newton Street Along Highway 20/34 (Recommended in 10-20 years)

Overview: Concerns have been expressed about the conflict between left-turning vehicles accessing Clemens Mill Road and Newton Street along Highway 20/34. The access points to these two roads are located only 350 feet apart on opposite sides of the highway. Twenty-sixth Street is located approximately 1000 feet west of Newton Street. These three intersections are too close together to install more than one traffic signal and allow for acceptable two-way traffic progression.

Several alternatives were considered in the public involvement process and by the TAC/TTSC. In the Newton Creek – Neer Street Environmental Assessment a new connection south of the highway to James/Newton Street was proposed at Clemens Mill Road. However this connection would go through East Newton Creek Park. A new connection on the north side of Highway 20/34 between Newton Street and Clemens Mill Road was also

discussed. This location would require some building removal. Twenty-sixth Street is located approximately half way between Bell Fountain Road and 19th Street, which are major north/south roads. Based on traffic operations the best location for a new traffic signal would be at 26th Street. However there are some wetland areas north of the highway that will need to be considered in determining the alignment for a connection between 26th Street and Clemens Mill Road. After discussing the alternatives the TTSC decided to include a project for a new connection north of Highway between 26th Street and Clemens Mill Road as part of this plan. Newton Street should also be connected to the east side of 26th Street south of Highway 20/34 (Option 7).

Impacts: Construction of a new connection north of Highway 20/34 directly across from 26th Street to Clemens Mill Road would create a common four-way intersection and remove the conflict of left-turning movements at staggered intersections. This new connection would also provide for better local access to Highway 20/34 and safety would be improved.

Costs: \$975,000

Recommendation: The previously discussed new connection project north of Highway 20/34 from Clemens Mill Road to 26th Street is recommended to provide safe highway access. This project will also provide for better connectivity in the local areas north of Highway 20/34.

Option 7. Extend Newton Street to 26th Street (Recommended in 5-10 years)

Overview: Newton Street ends east of 26th Street and is connected to the west side of 26th Street leaving a gap in Newton Street. This gap in Newton Street has been mentioned as a concern by local residents of Philomath. The connection of Newton Street also would complement project Option 6 on the south side of Highway 20/34.

Impacts: Extending and connecting Newton Street would provide an alternate east/west street on the south of Highway 20/34. The new connection of Newton Street would provide for better local access south of Highway 20/34. The City of Philomath owns the right-of-way (ROW) needed to construct the street.

Costs: \$125,000

Recommendation: This project will provide for better connectivity in the local area south of the Highway 20/34 and is recommended to improve local access.

Option 8. Street Overlays for Poor Pavement Condition Rated Roads (Recommended in 0-10 years)

Overview: The following is a list of streets identified in the existing street inventory as having poor pavement conditions:

- Highway 20/34 - West City Limits to Newton Creek Bridge.
- College Street - 12th Street to 20th Street.
- Grange Hall Road - Alsea Highway to Fern Road.
- Mt. Union Avenue - Benton View Drive to Plymouth Drive.

This project involves excavating (grinding) the old pavement in some cases and overlaying with new pavement on the roads listed above.

Impacts: Overlaying these roads will improve overall safety for drivers and bicyclists. It will also help to reduce road noise and improve street aesthetics.

Costs: Cost estimates for excavating and resurfacing are about \$2.35 per square foot of pavement area. This includes a 40 percent Engineering Contingency fee. The estimated costs for the pavement overlay projects are as follows:

A. Highway 20/34 - West City Limits to Newton Creek Bridge.	\$730,000
B. College Street - 12th Street to 20th Street.	\$690,000
C. Grange Hall Road - Alsea Highway to Fern Road.	\$300,000
D. Mt. Union Avenue - Benton View Drive to Plymouth Drive.	\$60,000

Recommendations: Resurfacing Highway 20/34 should take into consideration the implementation of any of the one-way couplet alternatives (Option 11), or widening Main Street to five lanes (Option 12). The resurfacing of College Street should take into consideration and be part of the two-way street project Option 10. Resurfacing Grange Hall Road and Mt. Union Avenue is recommended with the timing of these projects to be decided by county or city officials.

Option 9. Improved Street Signing in the City (Recommended in 0-5 years)

Overview: This project involves replacing all street name signs within the city limits with newer signs and was identified during the safety analysis. The existing city street signs are old and faded and in need of replacement.

Impacts: It is expected that traffic operations will be improved as a result of drivers being able to identify streets further in advance. More visible street signs at night are also expected to make night driving easier.

Costs: Costs to replace each sign are estimated at \$25 per sign for high intensity (high reflectivity) signs. Assuming that four signs are needed with two posts located at each of the 113 street intersections in the city, placed back to back for all lines of sight, a total cost of \$40,000 is estimated.

Recommendations: This project is recommended as a short range project to improve traffic safety and to also help bicyclists and pedestrians identify their locations.

A summary matrix comparing positive and negative considerations for the no build scenario and the next 3 options is shown in Table 6-1. Detailed discussions of the potential improvement options follow Table 6-1.

Option 10. College, Main, Applegate Two-way Streets (Recommended in 0-5 years)

Overview: This option was proposed as an alternative to developing a one-way couplet system along Highway 20/34 through Philomath, by providing optional travel routes along the existing roadway sections of College Street and Applegate Street, which parallel Main Street.

The proposed parallel alignment along College Street extends from 20th Street to 12th Street, creating an alternative route north of Main Street, which extends over half the length of the downtown grid. The second alignment along Applegate Street, extends from 21st Street to 7th Street, south of Main Street, and covers the entire length of the downtown grid system. Both College and Applegate Street were assumed to maintain a 25 mph speed with a street capacity of 700 vph, which is representative of a two-way street with one lane for each direction of travel.

Some major roadway improvements will be necessary to implement this option, particularly the widening and repaving of College Street. Applegate Street will also need subgrade improvements and new pavement, between 11th Street and 21st Street. Other improvements include two traffic signal installations at Main Street and 7th

Street, and at College Street and 19th Street. Traffic signals will be necessary at these two locations to handle future traffic demand.

Traffic Projections: Two important observations were made when comparing the 2015 p.m. peak hour traffic projections of this option with the No-Build alternative. One observation was the establishment of the parallel routes north and south of Main Street reduced the overall travel time through the downtown area. This, in turn, enticed more vehicles to use the major routes along Highway 20/34 and 19th Street, east and northeast of the city, instead of bypassing most of the downtown area by way of the West Hills Road and 9th Street route. Comparison of the traffic model output for both scenarios showed that a total of 400 westbound and 225 eastbound p.m. peak hour vehicles heading into and out of Philomath were diverted from the West Hills Road and 9th Street route, and rerouted onto Highway 20/34 and 19th Street.

With more traffic flowing through the downtown area, a second observation was noted. As congestion increased along Main Street, many vehicles shifted over to the parallel routes along College Street and Applegate Street. The magnitude of this shift was checked at two locations in the downtown area. The first location was between 20th Street and 12th Street, where both parallel routes are provided, and the second location was between 12th Street and 7th Street, where only one parallel route is provided along Applegate Street. In the first area, an average of 1,050, 1000, and 750 vehicles used College Street, Main Street, and Applegate Street, respectively.

These traffic volumes represent about 37%, 36%, and 27% of the total traffic moving through this section of the downtown area. In the second area, an average of 1,500 and 900 vehicles used Main Street and Applegate Street, respectively. These traffic volumes represent about 63% and 37% of the total traffic moving through this section of the downtown area.

Operations: Analyses of the traffic operations for existing signalized intersections and other critical unsignalized intersections were performed for this alternative. Results indicate the signalized intersections along Main Street, at 13th Street and 19th Street, will function sufficiently at LOS C and D, respectively. However, the operations of minor street movements at several unsignalized intersections will be insufficient with LOS E to F. These intersections include Main Street at 7th Street, Main Street at 9th Street, and 19th Street at College Street. It is possible to reach an acceptable LOS D at the intersection of 19th Street at College Street. This condition is also possible for the intersection of Main Street at 9th Street. However, the uneven spacing between this intersection and the existing signalized intersections at 13th Street and 19th Street, and the planned traffic signal at the Alsea Highway intersection, would inhibit good traffic signal progression along the highway. The estimated traffic operation for the intersection of Main Street at 7th Street with a traffic signal, is LOS E. The poor level-of-service can be attributed to the estimated high volume of left-turn movements on the south approach of 7th Street.

Traffic operations for those remaining unsignalized intersections along Main Street, at 12th Street, 20th Street, and 21st Street, where the parallel routes of College Street and Applegate Street diverge from or merge into Main Street, are expected to be adequate (LOS D or better).

The V/C ratios along all sections of Main Street were analyzed for this alternative to determine resulting roadway operations. V/C ratios in excess of 0.85 are indications of a substandard level-of-service (LOS E to F). The analysis indicates a moderate but tolerable amount of congestion will exist between 12th Street and 19th Street, where V/C ratios will reach up to a maximum of 0.72. However, congestion will be considerably high, east and west of this area. The corresponding V/C ratios along Main Street, or Highway 20/34, from west of 12th Street continuing past the Alsea Highway, and from east of 19th Street continuing east of Philomath, exceed 0.85, representing a LOS of E to F.

Impacts: This alternative adds considerable amounts of traffic to both College Street and Applegate Street through residential areas. The two way street alternative utilizes the capacity of the existing local street system and requires no additional right-of-way to be secured. However, this alternative cannot solve all the future congestion issues identified along Main Street (Highway 20/34), particularly east of 19th Street and west of 13th Street. This is due to the shortness in length and discontinuity of the proposed parallel routes of College Street and Applegate Street. These routes may divert some of the traffic off of Main Street for a distance of a few blocks, but where they reconnect into Main Street, bottleneaking of traffic will occur.

Future traffic operations at the unsignalized intersection of Main Street at 9th Street will be substandard, as will be the intersection of Main Street at 7th Street, even with a traffic signal installation.

Costs: The total estimated cost for this option is \$4.6 million. This includes roadway improvement costs of \$2.2 million and \$2.0 million along College Street and Applegate Street, respectively. It also includes costs associated with two traffic signal installations at Main Street at 7th Street and at 19th Street at College Street, each at an estimated cost of \$200,000 per signal. No right-of-way acquisition is necessary.

Recommendations: Since this option will not solve the future traffic congestion issues projected for Main Street (Highway 20/34), this option is not recommended as a permanent solution. However this option fits as phase 1 of the Applegate/College/Main one-way couplet and as such is recommended. As a result a traffic signal is recommended at 9th Street instead of 7th Street as discussed in the following option.

Option 11. Establish a One-Way Couplet along Highway 20/34 Using College Street and or Applegate Street (Recommended in 5 to 10 years)

This option involves establishing a one-way couplet through the city center of Philomath along Highway 20/34 (Main Street). The overall focus of this project is to mitigate the current and projected capacity deficiencies along the highway through town. A specific focus is to utilize the capacity of existing parallel roads such as College Street and Applegate Street, and to minimize the costs associated with major capacity improvements.

Both directions of travel along the one-way couplet would include two lanes of traffic: a striped bicycle lane on one side of the street and on street parking on both sides. A 25-mph design/operating speed was assumed along the proposed couplet alignment between 9th Street and 19th Street. Currently, the posted speed along the highway is 25 mph between 12th Street and 19th Street. Maintaining and extending this 25-mph design/operating speed to include an area between 9th Street and 19th Street may be desirable for several reasons.

First, the proposed couplet alignment will continue to traverse the central business district of the city where pedestrian activity is the highest. Slower travel speeds result in safer conditions for pedestrians. Second, as the city grows, more traffic will be accessing the highway from intersecting streets and driveways. Third, the couplet will traverse areas zoned for office and residential uses where 25 mph is an appropriate speed. Outside this area, a 35-mph design/operating speed was assumed between the western end of the couplet and 9th Street and between 19th Street and the eastern end of the couplet. These areas will have little traffic demand on minor intersecting streets and driveways, which would enable traffic on the highway to move safely at higher speeds.

Four potential one-way couplet improvements have been identified by the TTSC for analysis. Factors taken into consideration when selecting couplet route alignments include utilizing the reserve capacity of existing roads; minimizing the impacts to existing land usage; minimizing overall project costs; traffic circulation and street connectivity; and community safety and livability. The four potential one-way couplet improvements are described and evaluated in the following paragraphs (Couplet Improvements 11A, 11B, 11C and 11D).

Improvement 11A. College/Main/Applegate One-Way Couplet (Between the Railroad Crossing and Green Street)

Overview: This alternative establishes a one-way couplet beginning east of the railroad crossing on Highway 20/34 and ending at approximately Green Street. The description of connection locations may vary during the project development process as the designs are refined. In the eastbound direction, the one-way couplet includes a new roadway connection beginning east of the highway railroad crossing and proceeding to the west end of Applegate Street. The couplet then utilizes the existing alignment of Applegate Street up to about 200 feet east of 14th Street, where a new crossover roadway would proceed in a northeasterly direction and reconnect back into Main Street, about 200 feet east of 15th Street. From there, the couplet continues along Main Street, ending at Green Street. In the westbound direction, the couplet includes a new roadway connection between the highway at Green Street, and proceeds to the east end of College Street. It then follows along College Street to about 150 feet west of 13th Street, where it proceeds southwest along a new road to Main Street, about 150 feet west of 12th Street. From there, the alignment continues along Main Street to the west end of the couplet (see Figure 6-3).

Several factors were considered when determining the proposed locations for the two street connections which cross between Applegate Street and Main Street and between College Street and Main Street. One factor included maximizing the use of vacant land available in the area. This was done through discussion with local residents, the inspection of aerial photographs, and a cursory field review. Another factor included minimizing the impact to existing land uses (building removal). Another factor considered was the assumed curvature and length of the proposed couplet crossovers. With the proposed street cross-section and assumed design speed of 25 mph for the highway, a minimum length of less than 400 feet was assumed for each crossover, spanning a distance of less than one standard city block.

It should be noted that although the main goal of this potential couplet improvement is to use the existing alignments of College Street and Applegate Street, sections of these roads designated to be a part of the couplet would need to be redesigned and reconstructed to ODOT highway standards. This is due, in part, to an insufficient base and pavement strength of these city streets for the expected highway traffic.

The couplet project also includes the proposed installation of five new traffic signals: one on 9th Street at Main Street, two along 13th Street at College Street and Applegate Street, and two along 19th Street at College Street and Main Street. The existing signal at 19th Street and Main Street will have to be reconstructed to facilitate one-way travel for eastbound traffic.

Other improvements within the couplet area include adding two-way stop control at all minor streets and driveways intersecting the one-way couplet, except where a traffic signal exists or is proposed. Stop-control may be used at the intersections on Main Street where it is not part of the couplet, including the current signalized intersection at 13th Street. Also included in this project will be signing and striping for the one-way couplet. Bus stops and street lighting should be considered as part of this project.

Traffic Projections: The one-way couplet will allow more traffic to flow freely through the city center along Highway 20/34 in the future. This will attract traffic away from other less attractive alternative routes, such as West Hills Road to 9th Street, which bypass the downtown area, and redirect it onto the couplet.

A direct comparison between traffic projections for the No-Build scenario and this couplet alternative indicates a significant portion of the PM peak hour traffic will change routes. Approximately 400 vehicles westbound and 220 vehicles eastbound during the PM peak hour will shift from the West Hills Road/9th Street route to the two, more direct routes along West Hills Road/19th Street and Highway 20/34 through the city.

Operations: Establishing a one-way couplet through the city center of Philomath will reduce congestion considerably along Highway 20/34, in the area bounded by the couplet. Assuming a capacity of 2,000 vph exists for the two-lane one-way couplet, prospective v/c ratios for the PM peak hour along the couplet range between 0.43 and 0.79, indicating a moderate but acceptable level of congestion (LOS C to D).

Future traffic operations at each of the five proposed signalized intersections are estimated to operate at an acceptable LOS of D or better. Results of the operations analysis for these intersections are located in Appendix E.

Based on future traffic projections, highway traffic operations west and east of the couplet will not, however, be adequate. Traffic demand will roughly double the street capacity on Highway 20/34 between the Alsea Highway and the west end of the proposed couplet. As a two-lane highway, this section of road will have a v/c ratio during the PM peak hour of 1.71 in the westbound direction and 1.08 in the eastbound direction, indicating a LOS F rating. East of the couplet, traffic demand will exceed the highway's capacity to the eastern city limits. Volume-to-capacity ratios in this area will reach as high as 1.09 for the westbound traffic and 0.96 for the eastbound direction, also indicating a LOS F rating.

Future traffic projections also indicate a heavy level of congestion may exist during the PM peak hour along 19th Street, between College Street and Industrial Way, for the southbound direction. With traffic demand expected to reach 757 vehicles, a v/c ratio of 1.09 was calculated for southbound traffic. Although such a high v/c ratio may indicate an unacceptable level of congestion, actual congestion is expected to be less due to the functional characteristics of this particular section of 19th Street. Traffic on this road is essentially free-flowing since 19th Street has a three-lane cross-section, with a continuous left-turn lane, and only one driveway over a distance of 2,000 feet. This suggests the assumed EMME/2 model capacity of 700 vph is actually higher, somewhere in the vicinity of 900 vph.

Impacts: The proposed alignment would require obtaining ROW in the two areas where the couplet is redirected onto another existing road, i.e., Applegate Street to Main Street and College Street to Main Street. This could include the removal and/or relocation of four historic homes for the connection between Applegate Street and Main Street, and one home for the connection between College Street and Main Street. ROW will also have to be acquired in the two vacant areas located at the west and east ends of the couplet. There may be environmental impacts on wetlands and the stream/natural area in the vicinity of Newton Creek near the east end of the couplet project.

The proposed alignment would also require closing and/or rerouting several streets along College Street, Main Street, and Applegate Street to provide good street connectivity, safe driving conditions, and efficient traffic flow.

Costs: The following table provides the estimated costs for constructing this one-way couplet.

**TABLE 6-3
ESTIMATED COSTS FOR
COLLEGE/MAIN/APPLEGATE ONE-WAY COUPLET**

Improvement	Length (feet)	Existing Pavement Width (feet)	Proposed Pavement Width (feet)	Existing Right- of-Way (feet)	Proposed Right-of- Way (feet)	Right-of- Way Costs	Construction Costs
<i>New Highway Connections</i>							
East end of Couplet to East end of College St.	1,200	0	46	0	60	\$700,000	\$1,600,000
College St. west of 13th St. to Main St. west of 12th St.	600	0	46	0	60	\$700,000	\$550,000
Main St. west of 15th St. to Applegate St. west of 14th St.	600	0	46	0	60	\$700,000	\$550,000
West end of Applegate St. to west end of couplet	1,200	0	46	0	60	\$700,000	\$1,100,000
<i>Upgrade Existing Streets to Highway Standards</i>							
East end of College St. to west of 13th St.	3,150	20	46	80	80*	\$0	\$2,200,000
West end of Applegate St. to west of 14th St.	2,900	42	46	60	60*	\$0	\$1,000,000
<i>Five Traffic Signal Installations</i>						\$750,000	
Subtotal						\$2,800,000	\$7,750,000
Total						\$10,550,000	

*The proposed ROW width for College Street maintains the existing 80-foot width. The City owns the right of way along both College and Applegate Streets. This right of way would be a substantial contribution from the City towards implementation of this project.

Recommendations: This project alone is not recommended because it would not correct all of the future capacity deficiencies identified along Highway 20/34 in Philomath. Additional improvements such as the ones identified in Alternative 11C must be implemented along with the proposed one-way couplet for the highway system to function at an acceptable level of service.

Improvement 11B. Main/Applegate One-Way Couplet (Between the Railroad Crossing and Green Street)

Overview: It should be noted that this one-way couplet route was proposed in 1959. The alignment of this couplet was designed to fully utilize Main Street for westbound traffic and Applegate Street for eastbound traffic. The west end terminus of the couplet is east of the railroad, with the east end near Green Street.

This alternative establishes a one-way couplet beginning east of the railroad crossing on Highway 20/34 and ending at approximately Green Street. The description of connection locations may vary during the project development process as the designs are refined. In the eastbound direction, the one-way couplet includes a new roadway connection beginning east of the highway railroad crossing and proceeding to the west end of Applegate Street. The couplet then utilizes the existing alignment of Applegate Street to approximately Green Street, where a new crossover roadway would proceed in a northeasterly direction and reconnect back into Main Street. In the westbound direction, the couplet follows the existing Highway 20/34 (Main Street) alignment.

It should be noted that although the main goal of this potential couplet improvement is to use the existing alignments of Main Street and Applegate Street, sections of Applegate Street designated to be a part of the couplet

would need to be redesigned and reconstructed to ODOT highway standards. This is due, in part, to an insufficient base and pavement strength of this city street for the expected highway traffic.

The couplet project also includes the proposed installation of six new traffic signals: one on 9th Street at Main Street, two along 13th Street at Main Street and Applegate Street, one along Applegate Street at 15th Street and two along 19th Street at Main Street and Applegate Street. The existing signal at 19th Street and Main Street will have to be reconstructed to facilitate one-way travel for eastbound traffic. The traffic signal on Applegate at 15th Street would be expected to be needed to provide for school crossings with this couplet project.

Other improvements within the couplet area include adding two-way stop control at all minor streets and driveways intersecting the one-way couplet, except where a traffic signal exists or is proposed. Also included in this project will be signing and striping for the one-way couplet.

Traffic Projections: The one-way couplet will allow more traffic to flow freely through the city center along Highway 20/34 in the future. This will attract traffic away from other less attractive alternative routes, such as West Hills Road to 9th Street, which bypass the downtown area, and redirect it onto the couplet.

A direct comparison between traffic projections for the No-Build scenario and this couplet alternative indicates a significant portion of the PM peak hour traffic will change routes. Approximately 400 vehicles westbound and 220 vehicles eastbound during the PM peak hour will shift from the West Hills Road/9th Street route to the two, more direct routes along West Hills Road/19th Street and Highway 20/34 through the city.

Operations: Establishing a one-way couplet through the city center of Philomath will reduce congestion considerably along Highway 20/34, in the area bounded by the couplet. Assuming a capacity of 2,000 vph exists for the two-lane one-way couplet, prospective v/c ratios for the PM peak hour along the couplet range between 0.43 and 0.79, indicating a moderate but acceptable level of congestion (LOS C to D).

Future traffic operations at the proposed signalized intersections are estimated to operate at an acceptable LOS of D or better. Results of the operations analysis for these intersections are located in Appendix E.

Based on future traffic projections, highway traffic operations west and east of the couplet will not, however, be adequate. Traffic demands will roughly double the street capacity on Highway 20/34 between the Alsea Highway and the west end of the proposed couplet. As a two-lane highway, this section of road will have a v/c ratio during the PM peak hour of 1.71 in the westbound direction and 1.08 in the eastbound direction, indicating a LOS F rating. East of the couplet, traffic demand will exceed the highway's capacity to the eastern city limits. Volume-to-capacity ratios in this area will reach as high as 1.09 for the westbound traffic and 0.96 for the eastbound direction, also indicating a LOS F rating.

Future traffic projections also indicate a heavy level of congestion may exist during the PM peak hour along 19th Street, between Main Street and Industrial Way, for the southbound direction. With traffic demand expected to reach 757 vehicles, a v/c ratio of 1.09 was calculated for southbound traffic. Although such a high v/c ratio may indicate an unacceptable level of congestion, actual congestion is expected to be less due to the functional characteristics of this particular section of 19th Street. Traffic on this road is essentially free-flowing since 19th Street has a three-lane cross-section, with a continuous left-turn lane and only one driveway over a distance of 2,000 feet. This suggests the assumed EMME/2 model capacity of 700 vph is actually higher, somewhere in the vicinity of 900 vph.

Impacts: ROW will have to be acquired in the two vacant areas located at the west and east ends of the couplet where the eastbound traffic is redirected to and from Applegate Street. There may be environmental impacts on wetlands and the stream/natural area in the vicinity of Newton Creek near the east end of the couplet project.

This one-way couplet project was mentioned at both community open houses but there was little support for it. Residents along Applegate don't want the additional traffic including trucks. The TTSC also discussed this option and decided it was not a viable couplet project. The TTSC does not want additional highway traffic passing by the schools as it would create safety concerns for students at the elementary and high schools. There would also be other compatibility concerns with the schools such as additional noise and the other impacts of large vehicles adjacent to the schools.

Costs: The following table provides the estimated costs for constructing this one-way couplet project.

**TABLE 6-4
ESTIMATED COSTS FOR
APPLEGATE/MAIN ONE-WAY COUPLET**

Improvement	Length (feet)	Existing Pavement Width (feet)	Proposed Pavement Width (feet)	Existing Right- of-Way (feet)	Proposed Right-of- Way (feet)	Right-of- Way Costs	Construction Costs
<i>New Highway Connections</i>							
East End of Couplet to Applegate St.	1,200	0	46	0	60	\$700,000	\$1,100,000
West End of Applegate St. to West End of Couplet	1,200	0	46	0	60	\$700,000	\$1,100,000
<i>Upgrade Existing Streets to Highway Standards</i>							
West End of Applegate St. to east end Couplet Connection.	6,000	42	46	60	60	\$0	\$2,200,000
Main St. Improvements	2,800	42	46	80	80	\$0	\$1,000,000
<i>Six Traffic Signal Installations</i>							\$1,000,000
Subtotal						\$1,400,000	\$6,400,000
Total							\$7,800,000

Recommendations: This project is not recommended based on the lack of public support and the impacts on schools.

Improvement 11C. One-Way Couplet With Additional Capacity Improvements

Overview: This project includes the proposed one-way couplet (Improvement 11A) plus additional capacity improvements along Highway 20/34 within and just outside the UGB of Philomath. The first additional capacity improvement includes widening Highway 20/34 to four lanes, between the Alsea Highway intersection and the west end of the proposed couplet, with left-turn bays. It will also include reconstructing and widening the current railroad crossing on the highway. The second additional improvement includes widening the highway to four lanes, between the east end of the proposed couplet and the east UGB, with left-turn bays at one or more intersections (possibly at 24th Street, 26th Street, Newton Street, or Clemens Mill Road). Raised medians may be installed with openings at the left turn bays. Both improvements include the addition of bicycle lanes.

These additional capacity improvements were designed to address future capacity deficiencies in the highway system west and east of the proposed couplet, as identified in Improvement 11A.

Traffic Projections: The street improvements identified in this alternative will facilitate the movement of more through traffic along Highway 20/34 in Philomath, with less traffic using other alternative east-west routes. A direct comparison of projected PM peak hour traffic volumes between the proposed original one-way couplet alternative (Improvement 11A) and this alternative for the section of highway near the east city limits indicates an increase of 400 vehicles in the westbound direction and 270 vehicles in the eastbound direction. Most of this traffic was diverted from the alternative east-west routes along West Hills Road to 9th Street and 19th Street, and Plymouth Drive to Chapel Drive and 26th Street. Traffic volumes west of the proposed couplet will not change as Highway 20/34 is the only primary connection to the west.

Traffic Operations: With the establishment of a one-way couplet and the additional capacity improvements east and west of the couplet, future traffic operations along Highway 20/34 through Philomath are expected to meet minimum operating standard requirements. Volume-to-capacity ratios for the PM peak hour along the highway are not expected to exceed 0.85, which is the threshold point between LOS D and E. It should be noted that the EMME/2 traffic model estimated a v/c ratio of 0.92 along a section of the couplet between 15th Street and 17th Street for the westbound direction. From close inspection of the EMME/2 model, it was determined that future traffic volumes along this section of road will actually be lower. This error was due to the limitations of the EMME/2 street network, where not all of the intersecting local roads could be represented in the model.

Traffic operations at the proposed signalized intersections will operate sufficiently at a LOS of C to D or better with the construction of a one-way couplet and the additional capacity improvements.

Future traffic projections also indicate a heavy level of congestion may exist during the PM peak hour along 19th Street, between College Street and Industrial Way, for the southbound direction. With traffic demand expected to reach 725 vehicles with an hourly capacity of 700 vph assumed in the EMME/2 traffic model, a v/c ratio of 1.04 was calculated for southbound traffic. Although such a high v/c ratio may indicate an unacceptable level of congestion, actual congestion is expected to be less due to the functional characteristics of this particular section of 19th Street. Traffic on this road is essentially free-flowing since 19th Street has a three-lane cross section, with a continuous left-turn lane, and only one driveway over a distance of 2,000 feet. This suggests the assumed model capacity of 700 vph is too low, and should be higher (somewhere in the vicinity of 900 vph).

Impacts: Most impacts related to the proposed additional capacity improvements with the one-way couplet are similar to those of Alternative 11A with a considerable amount of traffic shifted off of local streets. Exceptions are additional ROW will be necessary to widen Highway 20/34 between the Alsea Highway and the west end of the couplet. Also, the city must coordinate plans for this project with the county and ODOT, since a portion of this project falls outside the city's UGB (between the west UGB and Alsea Highway).

The existing rail line crossing Highway 20/34 is privately owned. The city would need to confer with ODOT officials and the private owner of the rail line about plans to reconstruct and widen the existing railroad crossing.

No additional ROW is needed for widening Highway 20/34 between the east end of the couplet and the east UGB. However there could be some wetlands impacts in this section.

Costs: The following table summarizes the estimated costs for development of the one-way couplet (Improvement 11A) with additional capacity improvements (Improvement 11C) along Highway 20/34.

**TABLE 6-5
ESTIMATED COSTS FOR ONE-WAY COUPLET IMPROVEMENT 11A
WITH ADDITIONAL CAPACITY IMPROVEMENTS 11C**

Improvement	Length (feet)	Existing Pavement Width (feet)	Proposed Pavement Width (feet)	Existing Right-of- Way (feet)	Proposed Right-of- Way (feet)	Right-of- Way Costs	Construction Costs
One-Way Couplet (10A)*						\$2,800,000	\$7,750,000
Additional Capacity Improvements (10C)							
<i>Widen Highway to Four Lanes and Median</i>							
From Alsea Highway to West End of Couplet	800	36 (used)	72	60	90	\$300,000	\$450,000
<i>Widen Highway to 4 Lanes & Median</i>							
From East End of Couplet to Country Club Rd.	4,000	36 (used)	72	80	100	\$800,000	\$2,150,000
Reconstruct Railroad Crossing							\$700,000
Subtotal						\$3,900,000	\$11,050,000
Total							\$14,950,000

*Cost estimates for the one-way couplet includes five proposed traffic signals.

Recommendations: This street improvement project is recommended based on its ability to mitigate all future capacity deficiencies projected along Highway 20/34 in Philomath and to accommodate the travel demands.

Improvement 11D. Extended One-Way Couplet (West of Alsea Highway to Green Street)

Overview: This potential improvement is a variation of the proposed one-way couplets (Improvements 11A or 10B). It includes extending the one-way couplet west of the Alsea Highway before merging together at the existing US Highway 20. In the westbound direction, the extended couplet would follow the existing alignment of Highway 20/34. In the eastbound direction, traffic would follow a new highway connection beginning approximately 1,000 feet west of the Alsea Highway on US Highway 20. This connection would create a new intersection with the Alsea Highway and continue east to the west end of Applegate Street. A new railroad crossing would be necessary at one point along the new connection.

Traffic Projections: The traffic volumes projected for this couplet extension improvement are similar to the other one-way couplet improvements (11A & 11B). However, with the couplet extended further west, westbound traffic will now flow along the two existing lanes of Highway 20/34 with eastbound traffic flowing along the new highway connector.

Traffic Operations: Projected traffic operations along all major streets will be similar to conditions projected under the first one-way couplet improvement 10A except in the vicinity where the couplet extends further west. With westbound traffic now utilizing both existing lanes along Highway 20/34, v/c ratios in this area are expected to reach 0.67. Along the new highway connector for eastbound traffic, v/c ratios are estimated to reach 0.43.

The projected traffic operations for the signalized intersections proposed in the one-way couplet improvements 11A or 11B will not be affected by the couplet extension. Traffic operations at these intersections are expected to remain at a LOS D or better.

Additional operations analyses were performed at the two intersections where the extended couplet at US Highway 20 intersects the Alsea Highway. These intersections were analyzed using stop control on the minor approaches to Highway 20. The results indicate a LOS D would exist at the north intersection and a LOS E to F would exist at the south intersection for through movements.

Impacts: This improvement would have impacts similar to the one-way couplet improvements 11A or 11B with additional impacts related to the couplet extending further to the west. Additional ROW will be necessary along the new highway connection south of the existing Highway 20/34. Also, the proposed alignment for the new highway connection crosses over a rail line and traverses directly through a wood products mill on the southeast corner of the US Highway 20 and Alsea Highway intersection. As a result, it is expected that the adverse economic impacts of this alternative would not be acceptable.

Costs: The following table summarizes the estimated costs for development of the extended one-way couplet system.

**TABLE 6-6
ESTIMATED COSTS FOR EXTENDED ONE-WAY COUPLET**

Improvement	Length (feet)	Existing Pavement Width (feet)	Proposed Pavement Width (feet)	Existing Right- of-Way (feet)	Proposed Right-of- Way (feet)	Right-of- Way Costs	Construction Costs
<i>One-Way Couplet*</i>						\$2,800,000	\$7,750,000
<i>New Highway Connections</i>							
West End of Applegate St. to West End of Couplet	3,200	0	46	0	60	\$1,900,000	\$2,200,000
<i>Railroad Crossing</i>							\$700,000
Subtotal						\$4,700,000	\$10,650,000
Total							\$15,350,000

*The projected cost for the one-way couplet includes the five proposed traffic signals.

Recommendations: Based on the ROW costs, negative economic impacts and the difficult railroad crossing impacts (new crossing) this option is not recommended.

***Option 12. Widen Highway 20/34 to Five Lanes (Between Alsea Highway and Green Street)
(Not Recommended)***

Overview: This street improvement option was developed to address the current and future street capacity deficiencies identified along Highway 20/34 in Philomath with improvements made only to the existing highway. It includes widening the highway to five lanes, with a continuous left-turn lane between the Alsea Highway and the east end of the proposed one-way couplet near Green Street. Bicycle lanes and sidewalks are proposed along the entire project limits, and includes the addition of on-street parking on both sides of the highway from the west city limits to Green Street. A typical curb-to-curb street width for a highway such this one would be 72 feet without on-street parking and 88 feet with on-street parking. These widths are considerably larger than the existing street widths, which are 48 feet or less.

This project also assumes the installation of two new traffic signals along Highway 20/34 at the Alsea Highway and 9th Street. Good traffic progression in both directions would not be achievable with these signals on a two-way street. The evaluation of the 2016 No-Build scenario indicates that traffic signals are necessary at these two

locations due to increased traffic flow along the highway. With the highway widening, the two existing traffic signals at 13th Street and 19th Street would also have to be reconstructed.

Traffic Projections: A direct comparison of projected traffic volumes between this alternative and the No-Build scenario indicates more drivers will use the widened portion of Main Street through the center of town with less reliance on other alternative east-west routes such as West Hills Road to 9th Street and Chapel Drive to 13th Street. For the PM peak hour, traffic volumes are expected to increase along the highway east of 9th Street by 430 vehicles in the westbound direction and 200 vehicles in the eastbound direction. The most significant increases are expected west of 19th Street where traffic will increase by 530 and 320 vehicles for the same directions.

The traffic volume comparison does not show a significant increase in traffic along the highway east of 19th Street. Delays are expected to be heavy in this area as demand will exceed the highway's capacity (currently there is only one lane in each direction). Therefore, drivers will continue to rely heavily on the 19th Street/West Hills Road route to and from Corvallis, as in the No-Build scenario.

Traffic Operations: Traffic operations along the widened portion of Highway 20/34 are expected to be acceptable, with PM peak hour v/c ratios reaching a maximum value of 0.87 and 0.73 for the westbound and eastbound directions in the town center. Capacity deficiencies will still exist, however, east of the proposed improvement, near 26th Street, where v/c ratios are projected to reach 1.07 for westbound traffic and 0.95 for eastbound traffic.

PM peak hour traffic operations at the two proposed and two reconstructed traffic signals along Main Street are projected to maintain a LOS D or better. Analysis of these intersections assumed optimal lane configurations and signal phasing to achieve the best possible LOS. Impacts on 19th Street for this option are similar to the previously discussed options with southbound PM peak traffic volumes near capacity.

Impacts: Widening Highway 20/34 through Philomath would require the city and ODOT to secure additional ROW west of the city limits, where the existing ROW is 60 feet. In order to construct a five-lane road without parking and with bicycle lanes and sidewalks, a minimum ROW of 90 feet would be necessary. In the town center, between 7th Street and 19th Street, the existing ROW is 80 feet. If on-street parking, wide sidewalks (10 feet) and/or planting strips are desired in this area, which is typical for a main street arterial, a minimum ROW width of over 100 feet would be necessary. Such a ROW width may be difficult and prohibitively expensive (both monetary and livability impacts) to obtain along Main Street. At a minimum all existing buildings on one side of Main Street through the downtown would require removal.

Most of the commercial activity in Philomath is along or around Main Street, between 7th Street and 19th Street. There are on-street parking and planting strips in some areas providing a buffer between moving cars and pedestrians. By establishing a five-lane facility along Main Street, the environment would be less conducive to the needs of pedestrians. It may not be practical to maintain on-street parking and planting strips may with the wider ROWs associated with constructing five traffic lanes. Pedestrian safety may decline from the lack of these buffers as sidewalks may be placed adjacent to moving traffic. Also, crosswalk lengths will be longer as the number of travel lanes a pedestrian will have to cross increases from three to five along with the additional width from bike lanes and on-street parking. This distance may be unacceptable and unsafe for crossings at unsignalized intersections. These factors may be overly detrimental to the economy and livelihood of the town center.

Costs: The following table summarizes the estimated costs for widening Highway 20/34 to five lanes.

**TABLE 6-7
ESTIMATED COSTS TO WIDEN HIGHWAY 20/34
TO FIVE LANES IN PHILOMATH**

Improvement	Length (feet)	Existing Pavement Width (feet)	Proposed Pavement Width (feet)	Existing Right- of-Way (feet)	Proposed Right-of- Way (feet)	Right-of- Way Costs	Construction Costs
<i>Widen Highway to Five Lanes</i>							
Alsea Highway to West City Limits	1,900	36 (used)	72	60	90	\$600,000	\$1,100,000
West City Limits to 19th St.	5,000	48	88	80	100	\$4,000,000	\$5,600,000
19th St. to East End of Proposed Couplet	1,700	24 (used)	88	80	100	\$300,000	\$1,600,000
<i>Four Traffic Signal Installations</i>							\$800,000
Subtotal						\$4,900,000	\$9,100,000
Total							\$14,000,000

Recommendations: Although this project would mediate the capacity deficiencies identified along Main Street, this project is not recommended because of several negative impacts. Widening Main Street to five lanes (88 feet) would not be acceptable to pedestrians either to walk along the highway or to cross it. This would be detrimental to the economy and livelihood of the town center.

***Option 13. Extend West Hills Road to the US Highway 20/Alsea Highway Intersection
(Recommended beyond 20 year plan)***

Overview: Another possible solution to mitigate future capacity deficiencies identified along Main Street would be to extend West Hills Road to the US Highway 20/Alsea Highway intersection. This new road connection would be mostly in the City of Philomath and would allow traffic to bypass the city center. A similar road connection was shown in a draft of the Benton County TSP. It is expected that this road would be a collector street under city and or county jurisdiction. A bypass option identified but not evaluated as part of this TSP included a bypass north of Philomath providing a new connection between the City of Corvallis and US Highway 20/Kings Valley Highway near the City of Wren. This option was excluded under the assumption that the West Hills Road extension option would achieve results similar, if not better, than a bypass route further north of the city in terms of relieving congestion along Main Street in Philomath. The West Hills Road extension would also provide direct access to the Alsea Highway.

The West Hills Road option involves extending West Hills Road to the US Highway 20/Alsea Highway intersection, establishing a new route around the town center of Philomath. The goal of this roadway extension is to provide better road connectivity that will relieve future congestion along Highway 20/34 on Main Street while maximizing the utilization of existing roads, i.e., West Hills Road.

It was assumed that the West Hills Road extension would function as a major collector street for the city with a width of 40 feet to include two lanes of traffic and shoulders striped for bicycle lanes. A design/operations speed of 45 mph along with a directional peak hour capacity of 1,000 vph was assumed. These design characteristics

were selected to represent future urban controlled access conditions along this road when developments have been built along this road.

The project begins at the intersection of West Hills Road at 19th Street where the intersection will be realigned and a traffic signal installed. The proposed alignment then proceeds west along an existing section of West Hills Road, about 2,500 feet in length. This section of existing road will need to be widened from 20 feet to 40 feet. From this point, a new roadway will proceed to the southwest over open land for about 1,800 feet, where it will reconnect with and continue along another existing portion of West Hills Road, about 500 feet in length. Another new roadway, approximately 4,800 feet long, will extend further to the southwest where it will connect into the north side of the intersection of US Highway 20 and OR Highway 34. A traffic signal will also be necessary at this intersection.

Traffic Projections: Analysis between the future No-Build and West Hills Road extension scenarios indicates PM peak hour traffic will reduce along Highway 20/34 by about 49 percent east of the Alsea Highway, 20 percent east of 9th Street, and only two percent east of 19th Street. Future (2016) traffic volumes along the new West Hills Road extension are expected to range between 700 and 870 for the westbound direction and 380 and 460 in the eastbound direction.

Traffic Operations: Even with the proposed West Hills Road extension, traffic operations are expected to remain poor relative to the No-Build conditions along Highway 20/34, particularly in the downtown area. PM peak hour v/c ratios will still reach unacceptable levels in the future along the highway, i.e., east of 9th Street (0.94 westbound and 0.73 eastbound), west of 19th Street (1.14 westbound and 1.10 eastbound), and east of 26th Street (0.99 westbound and 0.83 eastbound). This means that there would be considerable traffic delay and traffic operations would not meet acceptable LOS standards.

Traffic operations at the proposed four-way traffic signal where West Hills Road will connect with the Alsea Highway and US Highway 20 are projected to reach LOS C. Traffic operations at the other two existing traffic signals in town along Main Street at 13th and 19th Street will be at LOS C to D, and D to E, respectively. Poor traffic operations will result at the existing unsignalized intersection of Main Street and 9th Street, particularly for the southbound and northbound movements (LOS F). A traffic signal would still be necessary at this intersection even with the proposed West Hills Road extension.

Impacts: Extending West Hills Road would require the cooperation between the city and county to secure the needed ROW along the proposed 1.8-mile alignment. Also, a portion of this project, about 30 percent, falls outside the city's UGB, which could require both jurisdictions to pursue an exception to the statewide planning goals when amending their comprehensive plans to include this project. Other impacts include possible environmental concerns where the southwestern section of the proposed alignment will traverse over hilly terrain. There are no expected historic property impacts.

Costs: The following table summarizes the estimated costs for extending West Hills Road to the US Highway 20/Alsea Highway 34 intersection.

**TABLE 6-8
ESTIMATED COSTS FOR THE
WEST HILLS ROAD EXTENSION**

Improvement	Length (feet)	Existing Pavement Width (feet)	Proposed Pavement Width (feet)	Existing Right- of-Way (feet)	Proposed Right-of- Way (feet)	Right-of- Way Costs	Construction Costs
New Roadway Connections	1,800	0	40	60	60	\$0	\$700,000
	4,800	0	40	0	60	\$1,450,000	\$1,900,000
Upgrade Existing Road	2,500	20	40	60	60	\$0	\$1,000,000
	500	20	40	40	60	\$50,000	\$250,000
Railroad Crossing							\$700,000
Two Traffic Signal Installations							\$400,000
Subtotal						\$1,500,000	\$4,950,000
Total							\$6,450,000

Recommendations: This option is not recommended for implementation as a road construction project within the 20-year planning period. The improvements identified and recommended in options 9, 10A and 10C are expected to delay the need for this collector road. However, the city and county should reserve the ROW along the proposed alignment and have portions of the road constructed as development occurs. The West Hills Road extension will be needed to provide for transportation beyond the 20-year planning period when traffic demands are again expected to exceed the capacity on Highway 20/34 in Philomath. This option is shown as part of the future street network in Philomath. It would serve as a future partial bypass and truck route and at the same time provide for better transportation system connectivity in Philomath. This option is also included to be consistent with the draft Benton County TSP.

***Option 14. Extend Applegate Street Over Newton Creek (Newton Creek Bridge)
(Recommended in 0-5 years)***

Overview: This project addresses the public's concern about a new roadway connecting Applegate Street between 23rd Street and 24th Street, over Newton Creek. Currently, drivers traveling between the city center and the residential neighborhoods south of Highway 20/34 and east of Newton Creek are limited to two routes; a somewhat indirect and short route along the highway or an indirect and long route along Chapel Drive. By providing a connection along Applegate Street, a more direct route between the two areas will be established.

This project would include the construction of a 75-foot-long bridge over Newton Creek with 50-foot connections at each end to connect with Applegate Street. The estimated width of this bridge is approximately 48 feet, which is wide enough to handle two lanes of traffic, bike lanes, and six-foot sidewalks. The estimated street width of the new approaches to the bridge is around 36 feet to allow two lanes of traffic and bike lanes. Five-foot sidewalks should also be provided on both sides of these approaches.

Traffic Projections: A direct comparison between the PM peak hour volumes projected for the Applegate Street extension and the No-Build scenario indicate that approximately 250 vehicles in the westbound direction and 300 vehicles in the eastbound direction will use the new Applegate Street bridge connection. Much of this traffic would otherwise use the highway to the north and some also would otherwise used Chapel Drive to the south.

Traffic Operations: With the Applegate Street connection in place, drivers making left turns from the minor street approaches along the highway at Green Street, 24th Street, 26th Street, and Newton Street would choose an easier

route along Applegate Street. Future PM peak hour traffic operations for left-turn movements at each of these intersections is estimated to be at LOS D with long delays.

Access management measures could be instituted at these intersections along the highway to encourage driver usage of Applegate Street, such as allowing only right-in and right-out movements.

Impacts: The new Applegate Street connection would improve the safety and convenience for local trip drivers that would otherwise access the highway. This connection is an important piece in linking the eastern residential neighborhoods to the rest of the city. It also improves the street connectivity and grid system of the city. There may be some natural area/wetland impacts near Newton Creek.

The city currently owns the right-of-way along the Applegate Street alignment.

Currently, a multi-use path crosses over Newton Creek in the vicinity of the proposed bridge. The new connection would include new bike lanes and sidewalks in place of this pathway.

Costs:

75' x 48' Bridge	\$450,000
Two Street Approaches @ 50' x 36'	\$150,000
<u>Total</u>	<u>\$600,000</u>

Cost estimates for this project assume a 40 percent engineering and contingencies fee. The estimate for the street approaches also includes costs for sidewalks.

Recommendations: This project is recommended to remove local intracity traffic along Highway 20/34 and to improve access between the residential neighborhoods in the eastern part of the city and the town center for Philomath residents.

Option 15. Extend 13th Street and Construct a New Road Between Industrial Way and 13th Street (Recommend do not include project in the current TSP)

Overview: This project would provide a connection between the east-west road of Industrial Way and the north-south road of 13th Street. The proposed alignment would extend Industrial Way about 1,600 feet to the west and extend 13th Street around 1,900 feet to the north, with possible connections at Houser Lane, Adams Street, and Monroe Street.

The existing dead end section of Industrial Way provides access to industrial land uses such as the lumberyard on the south side of Industrial Way and west of 19th Street. The existing dead end section of 13th Street provides access to a residential area. This new connector road would be constructed to collector street standards to serve both types of land uses.

Traffic Projections: Because of anticipated delays in the future along Main Street between 13th Street and 19th Street, the PM peak hour traffic projections indicate a considerable amount of traffic will use the new Industrial Way/13th Street connector. Traffic volume output shows a maximum of 410 vehicles heading west and south along the new road and 360 vehicles heading north and east. Most of this traffic would otherwise use 19th Street and Main Street to access or traverse the downtown area.

Traffic Operations: The traffic volume projections indicate that high levels of traffic accessing Industrial Way from 19th Street would necessitate a traffic signal installation at this intersection.

Impacts: The connection would allow residents from the neighborhoods north of Main Street and west of 13th better access to 19th Street. It would also enhance the existing grid system of the city and create good connections with existing local streets and other local roads planned for the future. Truck access would also be improved with this connector. The land for the new road sections is vacant.

Negative impacts would be expected for residences along the route due to increased traffic and noise, as well as taking truck traffic into the downtown commercial district.

Costs:

Roadway Cost	\$2,500,000
Right-of-Way Cost	\$1,000,000
Total	\$3,500,000

The total cost for this project is estimated at \$3,500,000. Project cost estimates assume a two-lane roadway around 3,500 feet in length and 48 feet wide, with bike lanes, on-street parking, and sidewalks on both sides of the street. The total roadway construction cost is estimated at \$2,500,000. The right-of-way cost is estimated at \$1,000,000 based on a 60-foot minimum width.

Recommendations: This project is expensive with no funding source and is not recommended as a project to be implemented as part of the current TSP. There are expected truck access benefits and some challenges with the negative residential impacts. It is recommended that the ROW be reserved and additional sections of this road network be constructed as development occurs. This road network should be included in the future street classification map for Philomath.

***Option 16. Construct New Roads Connecting 26th Street to West Hills Road and Chapel Drive.
(Recommend do not include project in the current Philomath TSP)***

Overview: This project includes two new roadway connections between West Hills Road and Chapel Drive along an alignment following 26th Street. The southern connection is between Chapel Drive and the south end of 26th Street (2,700 feet in length). There are two alternatives for the northern connection. Alternative A would extend 26th Street at the highway due north along the existing dirt road and between the two logging ponds maintained by one of the mills in Philomath to connect with West Hills Road west of a creek (5,400 feet in length). Alternative B would extend 26th Street at the highway north and then northeast to overlap Clemens Mill Road. It will end with a connection to West Hills Road directly across from Reservoir Avenue (6,100 feet in length).

Both options assume a two-lane roadway with bicycle lanes and sidewalks and a minimum ROW width of 60 feet. On-street parking on both sides of the street was assumed for the south connection but not for either of the north connections since the southern area is zoned for residential use and the northern area for industrial use.

Traffic Projections: The proposed street connection will essentially remove a minor amount of traffic (73 PM peak hour vehicles in the northbound direction and 147 vehicles in the southbound direction) that would otherwise use the West Hills Road/19th Street route to and from Philomath.

This project would not change the amount of traffic and congestion projected in the downtown area along Main Street in the future.

Operations: Traffic operations along Main Street and at critical intersections in the downtown area of Philomath are not expected to change relative to the No-Build scenario.

Impacts: Cooperation would be necessary between the city and the county to develop both the north and south street connections. The alignments for both connections pass over relatively open land outside the city limits but inside the UGB.

The south connection would serve as a primary connector to future residential developments. It also would expand the grid system of the city.

The first option of the north connection would pass over open land zoned for industrial use. Environmental considerations may be necessary in the vicinity of the logging ponds.

The proposed alignment of the second option for the north connection passes through the Pacific Softwoods Mill logging facility south of the railroad. The access to this facility would have to be retrofitted to the new street connector.

Both options for the north connection would provide an alternative access to Highway 20/34 from the industrial site located along Clemens Mill Road (see Option 6). These two north connection options may also have wetland impacts.

Costs: The following cost estimates for the south and north connections take into account the costs associated with drainage, curbs and sidewalks, signing, and a 40 percent engineering and contingencies fee.

South Connection

Roadway Cost	\$3,240,000
Right-of-Way Cost	\$810,000
Total	\$4,050,000

North Connection
(Alternative A)

Roadway Cost	\$4,590,000
Right-of-Way Cost	\$1,620,000
Total	\$6,210,000

(Alternative B)

Roadway Cost	\$5,185,000
Right-of-Way Cost	\$675,000
Total	\$2,970,000

Recommendations: There is no funding source identified and the projects are not a high enough priority to include as a TSP project. The expected traffic impacts were not substantial and wetlands may be impacted. However the project would provide for better local access and street connectivity. Based on the impacts it is recommended that the south connection of 26th Street to Chapel Road and Alternative B for the north connection along Clemens Mill Road be included on the future street classification map for Philomath. ROW should be reserved as development occurs.

Option 17. Construct New Roads Connecting 72nd Street to West Hills Road, Plymouth Drive and Bellfountain Road (Bellfountain Extension)
(Recommend do not include as a Philomath TSP project)

Overview: This project includes a new street connection east of Philomath along 72nd Street in Corvallis. Even though the road is outside of Philomath it would provide better connectivity for the area transportation system. The street connection would extend north from Plymouth Drive, east of Bellfountain Road, to West Hills Road, and is approximately 8,000 feet in length. Depending on the final alignment the project could create an additional crossing at Highway 20/34. The main goal for establishing a road at this location is to relieve future congestion along the highway by providing a route that links West Hills Road with Plymouth Drive, which are two alternative routes to using the highway. This would serve as an alternate route for truck traffic on Bellfountain Road. It was assumed this roadway would function as a rural collector and would be designed as a two-lane roadway, 36 feet wide, and have a design/operating speed of 45 mph.

Traffic Projections: The traffic forecast for this new connection indicates the north section of 72nd Street, from Highway 20/34 to West Hills Road, would not attract many drivers. PM peak hour volume projections for the year 2016 show only 170 vehicles in the southbound direction and 90 vehicles in the northbound direction. However, the southern section is expected to experience heavier traffic demand during the same time period at an estimated 300 vehicles in the southbound direction and 260 vehicles in the northbound direction.

Traffic Operations: This new connection would not improve the street or intersection deficiencies identified in the No-Build scenario.

Impacts: The proposed alignment is located primarily over open farmland and could utilize the ROW along several gravel roads. The proposed location of this roadway is outside the UGB of Philomath and partly inside the city limits of Corvallis. Therefore, this project would properly be addressed by City of Corvallis and Benton County officials in their TSPs. The proposed project has minimal traffic impacts in Philomath. It could attract some truck traffic away from the City.

It was determined by the TTSC that an extension of Mt. Union Avenue to Highway 20/34 would not be a feasible connection to Bellfountain Road because of the topographical features of the area and the current use of Mt. Union Avenue as a local neighborhood street. Also, the TTSC does not want to encroach on the cemetery located on the east side of Mt. Union Avenue with new road construction. Therefore, an alignment further to the east was propose, which is outside the city's UGB. The draft Benton County TSP also shows an alignment to the east outside the City of Philomath.

Costs: The following cost estimates for the 72nd Street connection take into account the costs associated with drainage, curbs and sidewalks, signing, and an engineering and contingencies fee.

Roadway Cost	\$6,000,000
Right-of-Way Cost	\$1,600,000
Total	\$7,600,000

Recommendations: This project is not recommended for the City of Philomath transportation project list during the next 20 years since traffic benefits for the City of Philomath are expected to be low on the north connection and the project cost is \$7,600,000. There would be some expected benefits for truck traffic on Bellfountain Road. This project lies outside the Philomath UGB and would be more appropriate for the City of Corvallis and or Benton County to include in their TSPs. However, since this project has future expected benefits and provides a

missing link in the street grid it is also recommended to be shown on the future Philomath street network to be consistent with the draft Benton County TSP.

Bicycle Improvement Options

The City of Philomath developed the *Master Philomath Bike Path and Trails Plan* in 1994 identifying 11 improvement projects aimed at increasing bicycle connectivity throughout the city. None of the improvement projects have been implemented to date. Some of the identified projects are associated with proposed roadway improvements or new roadways, while others involve improvements along existing roadways or involve new pathways. These and other projects were evaluated to develop a list of potential bike improvements. A total of 16 improvement options have been identified and are illustrated in Figure 6-4. Not all of these projects have been recommended over the 20-year planning period (See Chapter 7 - Bicycle Plan). The identified bicycle improvement options fall into three categories: (1) new roadway or roadway improvement options, (2) new or extended multi-use path improvement options, or (3) stand-alone bicycle improvement options not associated with identified roadway improvements.

According to the *Draft Benton County TSP*, all new roads, whether under state, county, or city jurisdiction, will include bike lanes. Roadway widening projects on state highways and county roadways will also provide for bicycle/pedestrian paths on shoulders.

Based on these guidelines, bicycle improvements (primarily bike lanes) were included in the new and improved roadway options evaluated previously in this chapter. Bicycle improvements associated with these roadway improvement options are listed, but not evaluated, in this section. Although multi-use path improvement options support bicycle use, these options are evaluated in the subsequent section on pedestrian improvement projects. Therefore, only those remaining bicycle improvement options not associated with identified roadway improvements are evaluated in this section.

Bicycle Improvements Associated with Identified New Roadway Projects

Overview: The street improvements listed previously in this chapter are larger scale projects designed to dramatically enhance the local street system in Philomath. They address specific major capacity, operations, and accessibility issues that currently exist or are expected to exist in the future. These roadway projects have provisions for developing bike and pedestrian facilities in the form of sidewalks, bike lanes and/or multi-use paths.

The following bicycle projects have been identified in association with potential roadway improvements that involve construction of new roads or major redevelopment of existing roads. Some of these projects have been identified in the *Master Philomath Bike Path and Trails Plan*.

All potential bicycle improvement options are shown graphically on Figure 6-4.

1. Add bike lanes to the proposed North 13th Street extension/Industrial Way connection from Main Street to 19th Street. Alternatively, improve 9th Street by adding bike lanes from Main Street to West Hills Road.
2. Add bike lanes to Highway 20/34, College Street, and Applegate Street within the city limits as part of the projects selected (Options 10, 11 and or 12).
3. Add bike lanes along potential 72nd Street (Bellfountain) extension from Plymouth Drive to West Hills Road (Benton County TSP).

4. Add bike lanes to potential West Hills Road extension westbound to Highway 20/34.
5. Add bike lanes to potential 26th Street extension between Chapel Drive and West Hills Road.

Impacts: Bike lanes provide an increased sense of safety and connectivity for users due to the provision of a clearly defined ROW that does not require weaving around parked cars or other impediments. Traffic capacity, if anything, may slightly improve since many motorists will not feel the need to unduly slow below the posted speed when passing bicyclists that are traveling in a separated and well-designed bike lane. This is not to say that motorists should not continue to pass bicyclists with caution, however they should feel more comfortable driving at the posted speed with bicyclists better separated from the traffic stream.

Costs: The cost of bicycle improvements along these potential roadway improvement projects was figured into the unit costs used to develop the overall project costs. However, a typical unit cost applied to construct six-foot asphalt bike lanes along an existing roadway, including ROW and engineering costs, is approximately \$130 per linear foot. This cost can be significantly reduced if bike lanes are included as part of planned roadway improvements.

Recommendation: Projects 1 and 2 are recommended as street improvement projects. Therefore, associated bicycle facilities are recommended for development with these two projects as well. Since Projects 3 through 5 are not recommended as new roadway projects, bicycle improvements will not occur as part of this TSP with these projects.

Bicycle Improvements Not Associated with Identified New Roadway Projects

All potential bicycle improvement options are shown graphically on Figure 6-4.

Option B1. Extend Existing Bike Lanes on North 19th from College Street to Chapel Drive (Recommended in 0-5 years)

Overview: This improvement option involves paving South 19th Street to accommodate six-foot bike lanes on both sides of the road. South 19th Street already has gravel shoulders allowing pavement of bike lanes.

Traffic Projections: According to the *Oregon Bicycle and Pedestrian Plan*, bike lanes are appropriate on minor collectors or arterials where speeds exceed 25 mph or average daily traffic (ADT) exceeds 3,000. Although the posted speed on this major collector is 25 mph, the 1996 ADT along South 19th Street was 3,800. Assuming a modest one percent per year increase over the next 20 years, the ADT would increase to over 4,500.

Impacts: Bike lanes provide an increased sense of safety and connectivity for users due to the provision of a clearly defined space to ride in that does not require weaving around parked cars or other impediments. Traffic capacity, if anything, may slightly improve since many motorists will not feel the need to unduly slow below the posted speed or weave across the roadway center-line when passing bicyclists that are traveling in a separated and well-designed bike lane. The middle school and a new grade school are also located off of South 19th Street.

South 19th Street is a county road and a coordinated street design standard and funding program between the jurisdictions would likely be needed. However, bike lanes along South 19th Street have also been identified as a proposed improvement option under the *Draft Benton County TSP*.

Costs: A cost estimate for this project was developed under the *Draft Benton County TSP* at a total cost of \$291,000 in 1996 dollars. Assuming a five percent per year increase, the 1998 estimated project cost is \$320,000.



(NOT TO SCALE)

LEGEND:

--- URBAN GROWTH BOUNDARY

..... CITY LIMITS

***** POTENTIAL BIKE LANES

..... POTENTIAL MULTI-USE PATH

(B1) BIKE OR PEDESTRIAN IMPROVEMENT PROJECT NUMBER

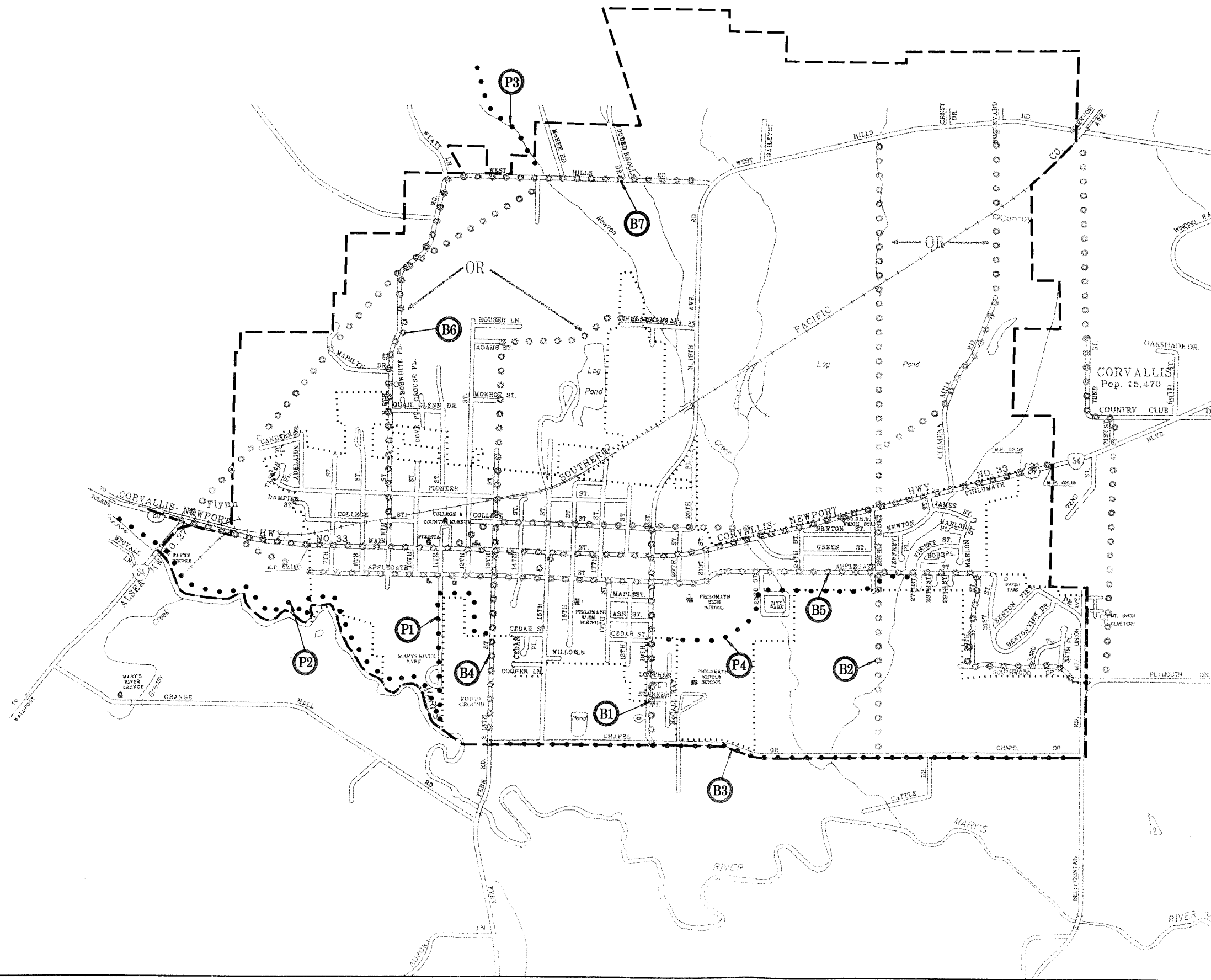

ODOT0254/FIG6-5.DGN/TNT/06-07-98

FIGURE 6-4

Potential Bicycle and Pedestrian Facilities

Recommendation: This project is recommended as a near-term project (0-5 years). However, Benton County funding availability will be a determining factor in the timing of this project and, as yet, the *Draft Benton County TSP* does not specify project timing.

***Option B2. Extend Bike Route From Plymouth Drive to Central Bike Path
(Recommended in 0-5 years)***

Overview: This improvement option involves signing for a bike route from Plymouth Drive along Southwood Drive, 30th Street, and Applegate Street to 26th Street. This route would also connect with the central bike path at the south tip of 26th Street. The city currently lacks a dedicated bicycle route connection between the downtown core and the increasing residential development in the southeast quadrant of the city near Plymouth Drive. This project would connect existing bike lanes along Plymouth Drive to the central bike path connecting Philomath and Corvallis.

Traffic Projections: It is not anticipated that Southwood Drive and 30th Street would experience ADTs of 3,000 or more in the year 2016, although traffic will increase subsequent to development of the Newton Creek Bridge. With a posted speed of 25 mph, these local streets will likely operate well as shared roadway facilities, not requiring dedicated bike lanes. However, it may be desirable to sign this as an on-street bike route connection between the established bike lanes on Plymouth Drive and the central bike path.

Impacts: Both Southwood Drive and 30th Street are approximately 32 feet wide and operate one lane in each travel direction, which would support an on street bike route.

Costs: The total cost to sign the bike route would be less than \$5,000.

Recommendation: This project is recommended as a near-term project (0-5 years).

***Option B3. Add Bike Lanes Along Chapel Drive Between 13th Street and Bellfountain Road
(Recommended in 5-10 years)***

Overview: This improvement option involves widening this rural section of Chapel Drive, which is under county jurisdiction, to accommodate 6-foot multi-use paths in each direction.

Traffic Projections: According to the *Oregon Bicycle and Pedestrian Plan*, bike lanes are appropriate on minor collectors or arterials where speeds exceed 25 mph or ADT exceeds 3,000. Based on EMME/2 model results assuming build conditions, the 2016 PM peak hour volume along Chapel Drive between South 13th Street and Bellfountain Road is expected to exceed 500 vph. Using the rule-of-thumb that PM peak hour volumes represent 10 percent of the ADT, the ADT is expected to be approximately 5,000. The posted speed along this major collector varies between 40 and 55 mph.

Impacts: As volumes continue to increase, bike lanes will provide an increased sense of safety and connectivity for users due to the provision of a clearly defined space to ride in that does not require weaving around parked cars or other impediments. Traffic capacity, if anything, may slightly improve since many motorists will not feel the need to unduly slow below the posted speed or weave across the roadway centerline when passing bicyclists that are traveling in a separated and well-designed bike lane.

Costs: A cost estimate was developed under the *Draft Benton County TSP* to widen Chapel Drive between South 19th Street and Bellfountain road at a total cost of \$744,000 in 1996 dollars. Assuming a five percent per year

increase, the 1998 estimated project cost is \$820,000. The total cost, including widening between South 13th Street and South 19th Street is estimated at \$1.1 million.

Recommendation: The project between South 19th Street and Bellfountain Road is recommended as an intermediate-term project (5-10 years). However, Benton County funding availability will be a determining factor in the timing of this project and, as yet, the *Draft Benton County TSP* does not specify project timing. If possible, the city should work with the county to extend the project limit westward to South 13th.

***Option B4. Add Bike Lanes Along South 13th Street from Main Street to Chapel Drive
(Recommended in 5-10 years)***

Overview: This improvement option involves widening South 13th Street to accommodate six-foot bike lanes in each direction. As a major collector, South 13th Street should be designed with bike lanes. This project would provide an additional north-south bikeway, in addition to potential bike lanes along South 19th Street, improving connectivity. Philomath is in the process of developing street design standards. In this evaluation, it was assumed that this collector roadway would consist of two 11-foot travel lanes, two six-foot bike lanes, two eight-foot parking lanes, and five-foot sidewalks on both sides. The overall pavement width would be 50 feet and the ROW width would be 60 feet, resulting in no necessary ROW purchase. This new design would be implemented south of Applegate Street only. North of Applegate, South 13th Street could be restriped to include bike lanes.

Traffic Projections: According to the *Oregon Bicycle and Pedestrian Plan*, bike lanes are appropriate on minor collectors or arterials where speeds exceed 25 mph or ADT exceeds 3,000. Based on EMME/2 model results assuming build conditions, the 2016 PM peak hour volume along South 13th Street between Chapel Drive and Main Street is expected to exceed 500 vph. Using the rule-of-thumb that PM peak hour volumes represent 10 percent of the ADT, the ADT is expected to be approximately 5,000. The posted speed along this major collector varies between 45 and 25 mph.

Impacts: As volumes continue to increase, bike lanes will provide an increased sense of safety and connectivity for users due to the provision of a clearly defined ROW that does not require weaving around parked cars or other impediments. Traffic capacity, if anything, may slightly improve since many motorists will not feel the need to unduly slow below the posted speed or weave across the roadway centerline when passing bicyclists that are traveling in a separated and well-designed bike lane. South 13th Street crosses from city jurisdiction to county jurisdiction near Cedar Street. A coordinated street design standard and funding program between the jurisdictions would likely be needed. No bike lane project along South 13th Street has been identified under the *Draft Benton County TSP*.

Costs: The unit cost used per linear foot in 1998 dollars, including engineering, was \$310. The total project cost is estimated at \$780,000.

Recommendation: This project is recommended as an intermediate-term project (5-10 years) to be completed in conjunction with identified future pavement rehabilitation work. Since the roadway is currently in fair to good pavement condition, this project most realistically would take place in five to ten years. The city should coordinate with Benton County for funding and project timing.

***Option B5. Add Bike Lanes Along Applegate Street Between Proposed Couplet and 26th Street
(Recommended in 5-10 years)***

Overview: Under the *Master Philomath Bike Path and Trails Plan*, the city has identified the need to add bike lanes along Applegate Street between 11th and 26th Streets. However, the couplet alignment would provide bike

lanes between approximately 7th and 15th Streets. Therefore, this improvement option completes the connection from 15th Street to the central bike path at 26th Street. Applegate Street is approximately 42 feet wide and operates one lane in each travel direction that would support restriping the roadway to include bike lanes. A street design including two 10-foot travel lanes with 4-foot bike lanes could be accommodated while allowing 7 feet on each side for on-street parking.

Traffic Projections: According to the *Oregon Bicycle and Pedestrian Plan*, bike lanes are appropriate on minor collectors or arterials where speeds exceed 25 mph or ADT exceeds 3,000. Based on EMME/2 model results assuming build conditions, the 2016 PM peak hour volume along Applegate Street at 26th Street is expected to exceed 370 vph. Using the rule-of-thumb that PM peak hour volumes represent ten percent of the ADT, the ADT is expected to exceed 3,700. The posted speed along this local street is 25 mph. With a posted speed of 25 mph, and relatively low projected traffic volumes, Applegate Street would probably continue to operate well in 2016 as a shared roadway facility, not requiring dedicated bike lanes. However, given the presence of schools which can generate a fair level of bicycle and pedestrian traffic, bike lanes would provide an increased sense of safety a formal bikeway connection between other potential bikeway facilities.

Impacts: As volumes continue to increase, bike lanes will provide an increased sense of safety and connectivity for users due to the provision of a clearly defined right-of-way that does not require weaving around parked cars or other impediments. Traffic capacity, if anything, may slightly improve since many motorists will not feel the need to unduly slow below the posted speed or weave across the roadway center-line when passing bicyclists that are traveling in a separated and well designed bike lane. One lane of on-street parking would need to be eliminated.

Costs: The unit cost per linear foot used for striping was \$0.50. Unit costs for roadway stencils and signs are \$30 and \$100 each, respectively. Assuming the need for approximately 16 stencils and eight signs, the total cost to stripe and sign bike lanes would be approximately \$5,000.

Recommendation: This project is recommended as an intermediate-term project (5-10 years) to be implemented in conjunction with couplet development and/or construction of the Newton Creek Bridge. Until such time as the Newton Creek Bridge is constructed, the eastern portion of Applegate Street should continue to operate effectively as a low-speed, low-volume shared roadway facility.

***Option B6. Add Bike Lanes Along North 9th Street Between Main Street and West Hills Road
(Not Recommended in this TSP)***

Overview: As an alternative to extending North 13th Street to West Hills Road, the city has identified the option to add bike lanes along North 9th Street between Main Street and West Hills Road. If North 13th Street is extended north to West Hills Road, it would be expected that bicycle lanes would be provided as part of that project. The north 13th Street extension could serve as an alternate route for bikes. North 9th Street converts from city to county jurisdiction about 1,000 feet north of Main Street. North 9th Street is fairly steep heading northbound, and sight distance could be a concern as bicyclists and motorists crest the hill. Within the city limits, 9th Street is approximately 40 feet wide and could be restriped to accommodate bike lanes and one lane of on-street parking. The majority of 9th Street is a 20-foot-wide rural road with no shoulders and narrow ROW.

Traffic Projections: According to the *Oregon Bicycle and Pedestrian Plan*, bike lanes are appropriate on minor collectors or arterials where speeds exceed 25 mph or ADT exceeds 3,000. Based on EMME/2 model results assuming build conditions, the 2016 PM peak hour volume along 9th Street/West Hills Road between Marilyn Drive and Wyatt Lane is expected to exceed 800 vph. Using the rule-of-thumb that PM peak hour volumes

represent 10 percent of the ADT, the ADT is expected to exceed 8,000. The posted speed along this major collector varies from 25 to 45 mph.

Impacts: As volumes continue to increase, bike lanes will provide an increased sense of safety and connectivity for users due to the provision of a clearly defined space to ride in that does not require weaving around parked cars or other impediments. Traffic capacity, if anything, may slightly improve since many motorists will not feel the need to unduly slow below the posted speed or weave across the roadway center-line when passing bicyclists that are traveling in a separated and well designed bike lane. One lane of on-street parking would need to be eliminated. Being fairly steep, the alignment of 9th Street would not work as well as the 13th Street extension and does not work as well as 19th Street. However, most older children and adults could ascend 9th Street by bicycle. The right-of-way along most of 9th Street/West Hills Road is between 40 to 50 feet. However, acquisition would not be required since providing on-street parking north of the city limits is not needed. North of the city limits, the potential alignment would consist of 12-foot lanes and six-foot bike lanes, resulting in a 36-foot pavement width.

Costs: The unit cost per linear foot used for striping was \$0.50. Unit costs for roadway stencils and signs are \$30 and \$100 each, respectively. Assuming the need for approximately eight stencils and four signs, the total cost to stripe and sign bike lanes would be approximately \$4,000. The unit cost per linear foot used to widen the roadway to 36-feet was \$160 including engineering and construction. Table 6-9 which follows shows the total estimated costs for this project.

**TABLE 6-9
ESTIMATED COSTS FOR WIDENING 9TH STREET/WEST HILLS ROAD FOR BIKE LANES**

Improvement	Length (feet)	Existing Pavement Width (feet)	Proposed Pavement Width (feet)	Existing Right- of-Way (feet)	Proposed Right-of- Way (feet)	Right-of- Way Costs	Construction Costs
Main St. to city limits (restriping only)	1,000	40	40	40	40	\$0	\$5,000
North of City limits to West Hills Road (widening)	4,500	19	36	40-50	40-50	\$0	\$765,000
Total						\$0	\$770,000

Recommendation: This project is recommended as a potential long-term project (beyond 20 years). However it is also recommended that this project be constructed as part of any development along 9th Street and any street resurfacing projects which occur before this proposed retrofit project can be implemented.

***Option B7. Add Bike Lanes Along West Hills Road Between Wyatt Lane and North 19th Street
(Recommended in 10-20 years)***

Overview: This option extends existing bike lanes along West Hills Road westward from North 19th Street to Wyatt Lane. This portion of West Hills Road is 20 feet wide with no shoulders and 60-foot ROW. It is all outside the City of Philomath and is a Benton County road inside the UGB. Extending these bike lanes to the west will provide for connections to other bicycle/pedestrian trails to the north in Benton County

Traffic Projections: According to the *Oregon Bicycle and Pedestrian Plan*, bike lanes are appropriate on minor collectors or arterials where speeds exceed 25 mph or ADT exceeds 3,000. Based on EMME/2 model results assuming build conditions, the 2016 PM peak hour volume along West Hills Road between Wyatt Lane and North 19th Street is expected to nearly reach 700 vph. Using the rule-of-thumb that PM peak hour volumes represent 10

percent of the ADT, the ADT is expected to nearly reach 7,000. The posted speed along this major collector is 45 mph.

Impacts: As volumes continue to increase, bike lanes will provide an increased sense of safety and connectivity for users due to the provision of a clearly defined right-of-way that does not require weaving around parked cars or other impediments. Traffic capacity, if anything, may slightly improve since many motorists will not feel the need to unduly slow below the posted speed or weave across the roadway centerline when passing bicyclists that are traveling in a separated and well-designed bike lane. The potential roadway cross section would consist of two 12-foot lanes and 6-foot bike lanes, resulting in a 36-foot pavement width.

Costs: The unit cost per linear foot used to widen the roadway to 36 feet was \$170 including engineering and construction. This unit cost results in an estimated total project cost of \$770,000.

Recommendation: This project is recommended as a potential long-term project (10-20 years).

Pedestrian Improvement Options

As discussed in Chapter 3, Transportation System Inventory, the City of Philomath lacks sidewalk connectivity along one or both sides of many roadways maintained by the city, county and state. As a result, pedestrians must frequently share the road with cars. Many sidewalk segments also lack curb cuts for wheelchair access. Projects listed in this section serve to enhance pedestrian access, safety, and connectivity between residential areas and community activity centers such as schools, parks, and open spaces.

The city has developed, and is in the third year of implementing, a comprehensive ten-year sidewalk development plan to address sidewalk deficiencies along roadways under their jurisdiction. Under the plan, all city streets with curbs and gutters, but without sidewalks, will be retrofitted with sidewalks. Additionally, the city's subdivision ordinance requires installation of sidewalks for all new development. A map depicting the planned sidewalk improvements by year between 1998 and 2005 is presented in Chapter 7 as part of the pedestrian modal plan.

All potential non-sidewalk pedestrian projects are shown graphically on Figure 6-4.

Option P. Develop Multi-Use Paths (Recommend Path 1 in 5-10 years, Path 2 in 10-20 years and Path 4 in 5-10 years)

Overview: Under its *Master Bike and Trails Plan*, the city identified development of four potential multi-use path facilities. These paths would provide access to both pedestrians and bicyclists.

Path 1 (P1): Under the city's proposed alignment, the first multi-use path would connect at South 13th Street between Applegate and Cedar Streets following westbound across the Frolic grounds and southbound across the Rodeo grounds and Mary's River Park, terminating at Mary's River.

Path 2 (P2): Under the city's proposed alignment, the second multi-use path would connect at Fern Road either near the Mary's River or at Chapel Drive paralleling the north side of the Mary's River, crossing the Alsea Highway. This alignment could support future connectivity as part of the proposed Corvallis-to-the-Sea Trail.

Path 3 (P3): The third multi-use path would connect West Hills Road between Wyatt Lane and McBee Road to the Benton County Open Space Park to the north.

Path 4 (P4): Under the city's proposed alignment, the fourth multi-use path would involve extending the existing central bike path from Applegate at South 26th Street to the city limits, then west to City Park/Philomath High School, terminating at 19th Street near Cedar Street. The western terminus at 19th Street would provide access to proposed bike lanes north and south along 19th Street.

Impacts: Paths 1 and 2 would connect the city's urban core with popular and scenic local destinations, improving pedestrian access, safety, and connectivity. The third path would connect Philomath with a desirable county resource in the Benton County Open Space Park. The fourth path would provide improved connectivity of Philomath parks and schools to destinations in residential areas and the City of Corvallis.

The character of a multi-use path supports safe and leisurely use by people of all ages. It is not intended to replace the need for a safe and connective system of sidewalks and bike paths along the surrounding street system. Rather, the multi-use path supplements these facilities.

Costs: A typical unit cost for a ten-foot wide multi-use path involving clearing, preparation, and construction of a two-inch asphalt surface over four-inch aggregate is \$50 per linear foot. This cost includes special engineering of potential problems such as steep grades, retaining walls, and drainage but does not include land acquisition. Estimated construction cost of Paths 1 and 4 is \$150,000 and \$200,000, respectively. Without a sense of potential alignment and connection to the proposed Corvallis-to-the-Sea Trail, reasonable cost estimates for Paths 2 and 3 would be very rough estimates. However Path 2 was estimated to cost roughly \$320,000. Path 3 is a long term project mostly outside the UGB and a cost estimate was not prepared for it. It would be more appropriate as a Benton County project.

Recommendations: It is recommended that the city design and construct Path 1 connecting South 13th Street to Mary's River as an intermediate term project within the next five to ten years. This project would improve pedestrian and bicycle access to desirable civic areas and scenic destinations at a reasonably low cost. It is also recommended that the city pursue development of the Mary's River path (Path 2) as a long-term scenic development project. Construction of the Mary's River path could easily be staged to complete shorter segments over the years as funding becomes available.

Additionally, it is recommended that the city extend the Central Bike Path (Path 4) to connect city resources such as City Park and the high school as an intermediate range project (5 to 10 years), potentially developed in concert with planned roadway improvements along Applegate Street. The larger scale and costlier Path 3 should be reviewed with the public to gauge public interest in its development. Path 3 is also outside the City and is more appropriate as a future Benton County TSP project. As a result Path 3 is not recommended for this Philomath TSP plan.

Transit

The Linn/Benton Transit Feasibility Study has been started and is expected to provide the policy and direction for transit in the City of Philomath. Results from this study should be used for the City of Philomath transit policies as part of the TSP in the future. It is also expected that any transit improvement projects needed for the City of Philomath will be identified as a part of the Linn/Benton Transit Feasibility Study or other Corvallis area transit study efforts.

Rail

It does not appear that additional rail service specifically for passengers to and from Philomath is economically practical at the present time for the Willamette Pacific Railroad. However this is being investigated for future feasibility and inclusion in a future update of the TSP.

Option 1. Rail Siding and Spur (Recommend in 0-5 years)

A new section of rail and spur is needed from the Willamette & Pacific Railroad to Georgia Pacific in Philomath.

Cost: \$250,000

Option 2. Intermodal freight facility

The possibility of a truck/rail intermodal freight facility in Philomath is also being explored consistent with the draft Highway 20/34 Interim Corridor Strategy Plan. However there does not appear to be the needed land available for this type of facility in Philomath. There also is a desire to develop freight rail service to the south and the most likely location for a truck/rail intermodal facility is south of the Corvallis and Philomath UGB's. This project would be expected to have some benefits for Philomath industries. As a result this project is recommended to be listed but not included in the project cost for Philomath.

Air, Water, and Pipeline

Air service is provided at the Corvallis Airport located in Benton County. There are no air transportation facilities available in the City of Philomath UGB.

The City of Philomath has no water borne transportation facilities.

The City of Philomath has no pipeline transportation facilities.

CHAPTER 7: TRANSPORTATION SYSTEM PLAN

The purpose of this chapter is to provide operational plans for each of the transportation systems within the City of Philomath community. The Philomath Transportation System Plan covers all the transportation modes that exist and are interconnected throughout the urban area. Components of the street system plan include street classification standards, access management recommendations, transportation demand management measures, modal plans, and a system plan implementation program.

STREET FUNCTION CLASSIFICATION AND DESIGN STANDARDS

Street standards relate the design of a roadway to its function. The function is determined by operational characteristics such as traffic volume, operating speed, safety, and capacity. Streets are the city's largest and most used public space. Street standards are necessary to provide the city with roadways that are designed to be attractive places for residents, pedestrians, bicyclists and drivers. Street standards must also create streets that are cost effective to build and maintain while at the same time allow for safe and efficient movement of traffic. Street standards are based on engineering and urban design standards, and state and local policies.

Street System Functional Classification

Street system functional classifications relate the design of a roadway to its function. Street function ranges from freeway (primarily through traffic, high speed and complete access control) to local (local traffic, low speed and primarily local access with no access control). Operational characteristics such as traffic volume, operation speed, safety and capacity are characteristics that help determine the appropriate functional classification.

The City of Philomath currently classifies all streets within the corporate boundary as either major arterials, minor arterials, collectors or local streets. Except for north 19th Street most of the collector streets do not meet the design standards of collectors, which may include multiple travel lanes, on-street parking, curbs and sidewalks and access limitations. In addition, the TPR requires that streets classified as major collectors or higher (including major and minor arterials) must include bike lanes. Currently, none of the major or minor arterials in Philomath include bike lanes.

This plan recommends that the existing street classifications be retained in Philomath with several additions to provide for a more complete street network and to meet the expected future demands. Figure 7-1 shows the recommended future street classification plan for the City of Philomath. General descriptions for the four street classifications in this plan for the City of Philomath are as follows:

- Major Arterial (Main Street, Highway 20/34) These types of highways (streets) carry high volumes of traffic and are usually multi-lane (more than two lanes) in urban areas. The primary function of these streets is mobility and to provide for intercity traffic with the access function being minor.
- Minor Arterial (Alsea Highway 34) As compared to a major arterial this type of highway usually carries less traffic (moderate volumes), has trips of shorter length (moderate length) and serves on a smaller area basis to interconnect residential, industrial, commercial and recreational. The access function for these types of highways is of substantial importance.

- Collector The function of collector roads is to connect local streets, neighborhoods, commercial and industrial areas with the arterial roadway system. These roadways have the serving local access function as a high level of importance with the movement of traffic having some (lower) importance.

Existing Street Standards

There are no existing street standards outlined under the Philomath Comprehensive Plan. However, the city is in the process of designing street standards and has completed draft standards for review. Additionally, the City adopted in June 1994 and revised in March 1996, the City of Philomath Subdivision Ordinance. The ordinance established specific street design guidelines including minimum right-of-way and street widths.

Table 7-1 summarizes the existing minimum right-of-way and roadway width standards for city streets in Philomath.

**TABLE 7-1
RIGHT-OF-WAY AND ROADWAY WIDTH STANDARDS**

Classification	Minimum Right-of-Way Width (ft.)	Minimum Roadway Width (ft.)
Highways - One-way streets	60	44
Highways - Two-way streets	100	84
Arterials - Local	70-80	42
Collector Streets	60	36
Minor Streets over 1,800 feet in length or which can be extended to such length	60	36
Minor Streets under 1,800 feet in length that cannot be extended to such length	50	36
Cul-de-sac Street	50	28
Turnaround radius at end of cul-de-sac	45	37
Alley	20	20

Source: City of Philomath Subdivision Ordinance, adopted June 1994, revised March 1996.

The City's sidewalk ordinance specifies a minimum sidewalk width of 5 feet except in business and commercial zones where 10-foot wide sidewalks are required. The subdivision ordinance requires sidewalks to be built on both sides of a public street.

There are no requirements for integrating bicycle facilities into the existing roadway standards. However, under the subdivision ordinance, the planning commission may require the addition of bicycle facilities where "appropriate to the extension of a system of bicycle routes, existing or planned..."

Recommended Street Standards

Based on the requirements of the Oregon Transportation Planning Rule and the results of the Philomath Community Design Preference Survey, a broader, more detailed range of street types are proposed. These new standards include narrower street widths than are currently allowed. Additionally, the Land Conservation and Development Commission (LCDC) adopted a rule in 1995 requiring local governments to adopt street standards which "minimize pavement width" as part of the adoption of a Transportation System Plan. Narrower streets have several benefits to the community.

- **Narrow streets cost less to build and maintain.** Less road base is needed and less surface area is paved. This results in lower material and labor costs. For example, the City of Eugene staff has estimated that an 8-foot reduction in residential street width results in at least a 10% reduction in paving, sidewalk and finishing costs.
- **Narrow streets reduce the negative impacts of storm water runoff.** Paved streets are impervious surfaces, which prevent the filtration of stormwater into the ground. Therefore, streets increase the volume of stormwater runoff, which can cause flooding, erosion, and habitat destruction. Excess paving also reduces the groundwater supply and causes increased pollution of surface waters as a result of contaminants from the road entering the stormwater system.
- **Narrower streets reduce the negative environmental impacts of street construction.** A narrow street cross section will help minimize environmental impacts by requiring less than a wider street. For improvements on existing unimproved streets, narrower widths will reduce the need to remove existing plants and trees.
- **Narrow streets encourage more efficient land use.** The land saved by using narrow street designs can be used for other purposes including housing, landscaping, and open spaces.
- **Narrow streets are safer streets.** Narrow street designs will discourage the use of local streets by through traffic and help reduce traffic volumes and speeds. According to Residential Streets, published in 1990 by the American Society of Civil Engineers, The National Home Builders, and the Urban Land Institute, "excessive widths...encourage greater vehicle speeds." Lower vehicle speeds reduce the occurrence and severity auto accidents, including those between autos and pedestrians and bicyclists. According to the Center for Urban Transportation Research, approximately 55% of accidents are fatal to the pedestrian when vehicle speeds are 30 mph and over, while only 5% are fatal when speeds are 20 mph and lower. A 1997 study by Swift and Associates has additionally shown that narrow residential streets pose no greater risk of fire-related injuries, and that given the large increase in traffic safety posed by narrow streets, if good connectivity of the local street system is encouraged and maintained, there is no apparent fire response benefit of wider streets.
- **Narrow streets improve neighborhood character.** The positive environmental, land use, and traffic safety impacts of narrow streets all work to improve the character and livability of neighborhoods. Narrow streets create an environment of safety and convenience which attracts residents to walk, bicycle and play in the neighborhood, while maximizing the opportunities for other neighborhood amenities like parks and landscaping through the efficient use of land.

Table 7-2 summarizes the recommended street standards for state highways, county roads and local streets in the Philomath UGB.

**TABLE 7-2
RECOMMENDED STREET STANDARDS FOR STATE HIGHWAYS, COUNTY ROADS AND LOCAL STREETS**

Type of Street	R.O.W. Width	Paving Width			(a) Sidewalks	(b) Planting Strip	Max. Corner Radius	(c) Bike Lane	Average Daily Traffic (ADT)
		No Parking	Parking One Side	Parking Both Sides					
1- Way Alley (d)	20'	12'	NA	NA	None	None	10'	Shared	NA
2- Way Alley (d)	20'	16'			None	None	10'	Shared	
Access Lane (e)(f)	41.5'	NA	20.5' (6.5'/14')		1 @ 6'	2 @ 7.5'	10'	Shared	<250
Access Lane (e)(f)	54'			27' (6.5'/14'/6.5')	2 @ 6'	2 @ 7.5'	10'	Shared	ADT
Low-Volume Residential (e)	47'	20' (10'/10')	21.5' (6.5'/14')	27' (6.5'/14'/6.5')	2 @ 6'	2 @ 7.5'	10'	Shared	250 to 750
Low-Volume Residential (e)	47'				2 @ 6'	2 @ 7.5'	10'	Shared	ADT
Low-Volume Residential (e)	54'				2 @ 6'	2 @ 7.5'	10'	Shared	
Medium-Volume Res. (e)	50'	20' (10'/10')	27' (7'/10'/10')	33' (6.5'/10'/10'/6.5')	2 @ 6'	2 @ 9'	10'	Shared	>750
Medium-Volume Res. (e)	55'				2 @ 6'	2 @ 8'	10'	Shared	ADT
Medium-Volume Res. (e)	60'				2 @ 6'	2 @ 7.5'	10'	Shared	
Non Highway Arterial and Industrial Streets	57' - 70'	30 (4'/11'/11'/4')	35.6' (4'/11'/11'/6.5'/4')	43' (4'/6.5'/11'/11'/6.5'/4')	2 @ 6'	2 @ 7.5'	20'	2@4'	NA
Main Street (non-highway) (h)	60'-80'	NA	NA	36' (7'/11'/11'/7')	2 @ 12'	None	10'	Shared	NA
Highway Couplet (h)	60'-80'	NA	36.5' (4'/11'/11'/6.5'/4')	43' (4'/6.5'/11'/11'/6.5'/4')	2@ 6-12' (i)	2 @ 9.5'	15'	2@4'	NA
Two-way Highway (h)	60'-80'	(limited)	37' (4'/11'/11'/7'/4')	44' (4'/7'/11'/11'/7'/4')	2@ 6-12' (i)	2 @ 9.5'	15'	2@4'	NA

- (a) Minimum sidewalk dimension; includes a paved walk and 1' strip behind the walk. For curbside sidewalks, (allowed only on access lanes) the sidewalk dimension includes a 5' paved walk and 6" curb (5'-6" total); the 1' strip behind the walk is added to the planting strip dimension.
- (b) Minimum widths. Planting strip dimension includes 6" curb. For curbside sidewalks, an additional 6" would be added to the planting strip dimension.
- (c) As indicated, on lower volume streets, bicycles can safely share the roadway with autos.
- (d) In addition to the ROW width, alleys require a minimum setback of 2' on each side for a minimum 20' backup distance.
- (e) Additional parking to accommodate occasional high parking demand may be provided in congregate parking areas such as parking bays.
- (f) Applies to cul de sacs and through streets. To maintain street connectivity, cul de sacs and other dead end streets are prohibited unless extreme physical or environmental constraints prevent through street connection; they also must include a bike and pedestrian pass-through wherever possible.
- (g) Cul-de sac bulb radius should be minimized. T-shaped turn-arounds are encouraged over bulbs on dead ends streets (also see (f)).
- (h) Landscaped medians are encouraged for these roadways when possible. ROWs and Pavement widths above do not include medians.
- (i) Wider sidewalks are encouraged in commercial areas.

Street Sections

Typical cross sections have been developed for several street types within the Philomath UGB. These cross-sections are intended to use as guidelines in the development of new roadways and the upgrade of existing roadways. Figures 7-2 and 7-3 provide typical roadway cross-sections for the various street types identified in the recommended street standards.

Each cross section details lane width, bicycle lanes, parking, sidewalks, landscape (planting strip) areas, and necessary right-of-way. Not all contingencies have been detailed in the cross-section because the list would be far too large. To accommodate special circumstances, cross sections can be modified. For example, it may not be desirable to have a sidewalk on the side of a roadway fronting a wetland; the appropriate cross section can be developed by deleting the sidewalk from the cross section designed for the particular type of roadway. Such modifications should be reviewed by all pertinent City departments (Planning, Fire, Police, and Public Works) and must be approved by the City Planning Official and City Public Works Director.

Most streets reflect the options available for three levels of on-street parking. For residential streets, whether there is no on-street parking, limited on-street parking or unlimited on-street parking will be determined by presence or absence of garages and the resulting driveway width. For non commercial streets, the appropriate level of on street parking will be determined based on the overall existing or planned land use of the area. The specific roadway cross-section should be determined at the time of site plan review based on the land use fronting the roadway. Bicycle lanes should be designed for all arterial streets including Highway 20-34. To keep the roadways from becoming overly wide, bicycle lanes are 4 feet in width and parking lanes are typically 6.5 feet in width. Wider bicycle lanes should be considered when adjacent to on-street parking on high-volume roadways. The State of Oregon Department of Transportation's Bicycle and Pedestrian Plan and Design Manual should be consulted when designing bicycle lanes. For overall consistency of the city's transportation system, the TSP includes proposed land use revisions to integrate land use and development requirements with the revised street standards.

A major objective of the Philomath Transportation System Plan is to enable residents to achieve many destinations through alternative modes of transportation, not through moving faster, or further, in a single mode. These new street standards are intended to foster a more livable and balanced community transportation system. These standards integrate the mobility of each mode of travel into the city's community development process. Incorporating a wide variety of street design features into this process is a way to make the city's streets usable for all travel.

Street standards recommendations were developed by the Cascades West COG and are shown in the following table. Table 7-3 summarizes the recommended right-of-way and roadway width standards for state highways, county roads and city streets in the Philomath UGB.

FIGURE 7-2

Typical Low-Volume Residential Street
No Scale

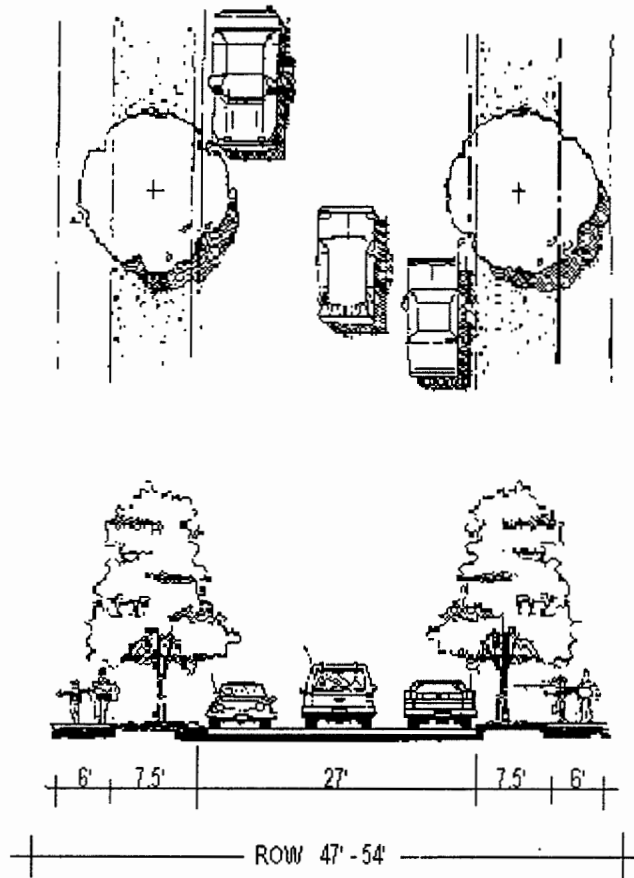

Typical Medium-Volume Residential/Collector St. - No Scale

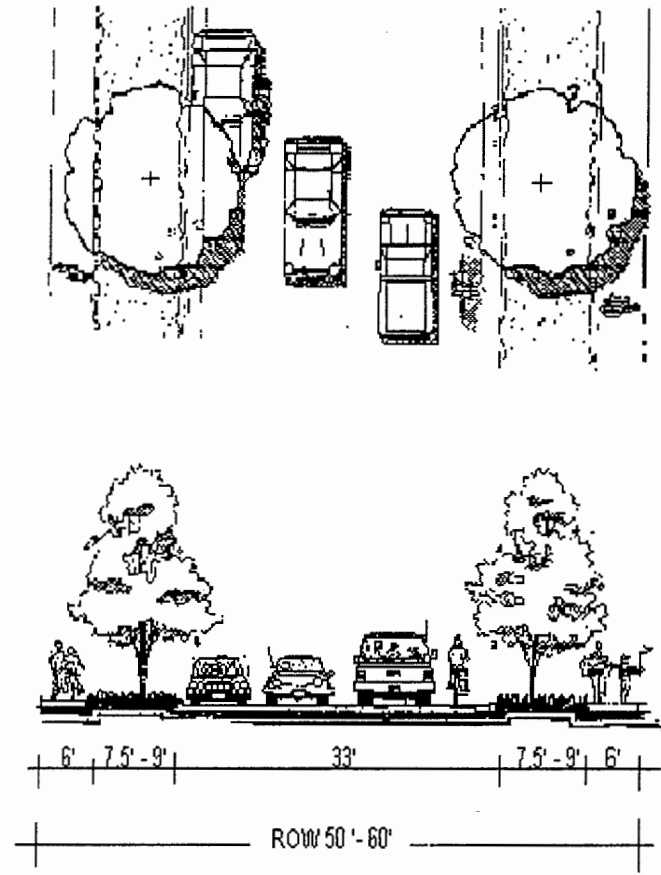
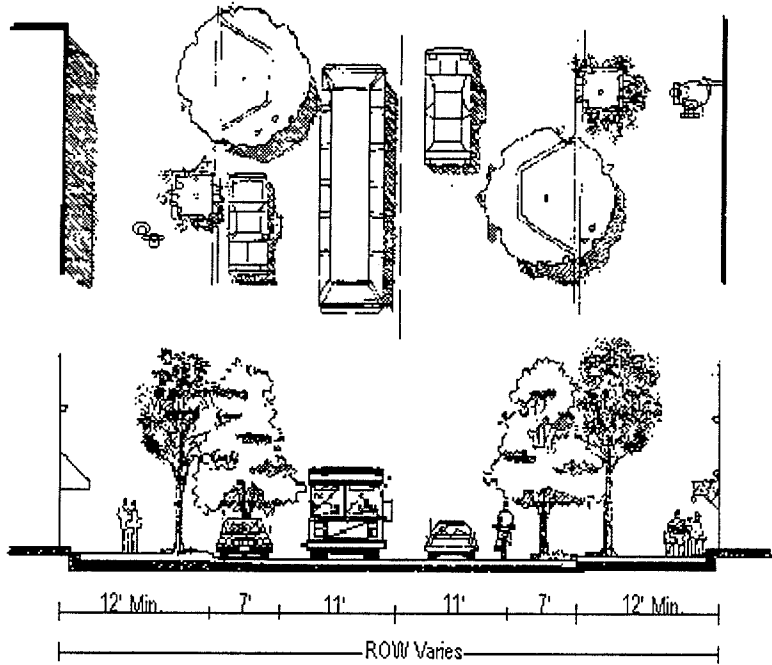
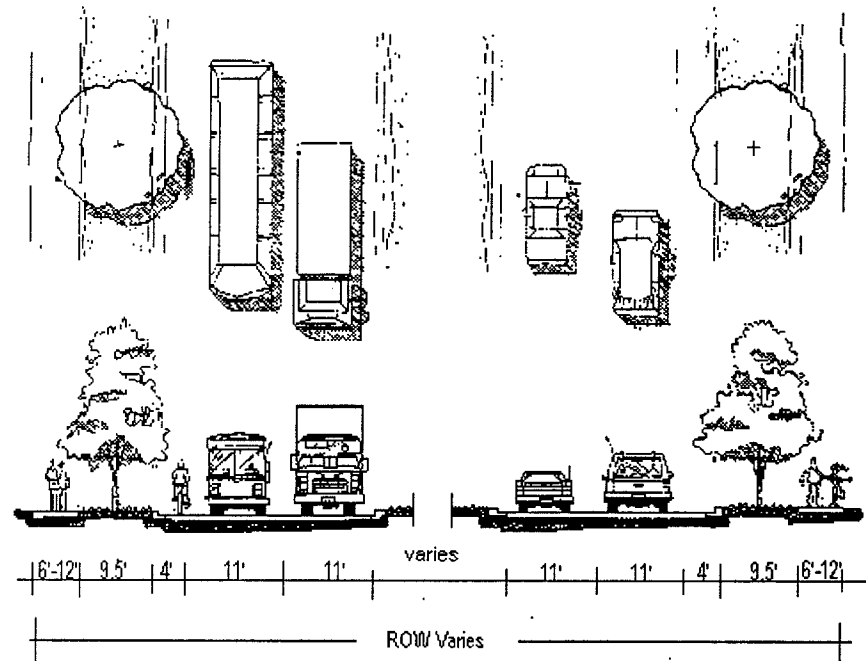

FIGURE 7-3

Typical Main Street Section - No Scale



Typical Couplet Street Section - No Scale



**TABLE 7-3
RECOMMENDED
RIGHT-OF-WAY AND ROADWAY WIDTH STANDARDS**

Classification	Minimum Right-of-Way Width (ft.)	Minimum Roadway Width (ft.)
Arterial Highways - One-way streets	70	46
Arterial Highways - Two-way streets	100	84
Arterials – Minor (non-highway)	60-80	46
Collector Streets	60	36
Minor Streets over 1,800 feet in length or which can be extended to such length	60	32
Minor Streets under 1,800 feet in length that cannot be extended to such length	50	28
Cul-de-sac Street	50	28
Turnaround radius at end of cul-de-sac	45	37
Alley	20	20

ACCESS MANAGEMENT

Access management is an important tool for maintaining a transportation system. Too many access points can diminish the function of an arterial, mainly due to delays and safety hazards created by turning movements. Traditionally, the response to this situation has been to add lanes to the street. However, this can lead to increases in traffic and, in a cyclical fashion, require increasingly expensive capital investments to continue to expand the roadway.

Reducing capital expenditures is not the only argument for access management. Additional driveways along arterial streets lead to an increased number of potential conflict points between vehicles entering and exiting the driveway, and through vehicles on the arterial streets. This not only leads to increased vehicle delay and deterioration in the level of service on the arterial, but also leads to reductions in safety.

Research has shown a direct correlation between the number of access points and collision rates. In addition, the wider arterial streets that can ultimately result from poor access management can diminish the livability of a community. Therefore, it is essential that all levels of government maintain the efficiency of existing arterial streets through improved access management.

Access Management Techniques

The number of access points to an arterial can be restricted through the following techniques:

- Restricting spacing between access points (driveways) based on the type of development and the speed along the arterial.
- Sharing of access points between adjacent properties.
- Providing access via collector or local streets where possible.

- Constructing frontage roads to separate local traffic from through traffic.
- Providing service drives to prevent spillover of vehicle queues onto the adjoining roadways.
- Providing acceleration, deceleration, and right-turn only lanes.
- Offsetting driveways to produce T-intersections to minimize the number of conflict points between traffic using the driveways and through traffic.
- Installing median barriers to control conflicts associated with left-turn movements.
- Installing side barriers to the property along the arterial to restrict access width to a minimum.

Recommended Access Management Standards

Access management is hierarchical, ranging from complete access control on freeways to increasing use of streets for access purposes, parking and loading at the local and minor collector level. Table 7-4 describes recommended general access management guidelines by roadway functional classification.

**TABLE 7-4
RECOMMENDED ACCESS MANAGEMENT GUIDELINES**

Functional Classification	Intersections					
	Public Road		Private Drive ⁽²⁾		Signal	Median
	Type ⁽¹⁾	Spacing	Type	Spacing	Spacing ⁽³⁾	Control ⁽⁴⁾
Arterial						
Highway 20: Two Way General (Category 4)	at-grade	¼ mile	L/R Turns	500 ft.	½ mile	Partial
West of 7th St. to East of 19 th street (one-way)	at-grade	400 ft.	L/R Turns	100 ft.	400 ft.	na
Alsea Highway : General (Category 5)	at-grade	¼ mile	L/R Turns	300 ft.	¼ mile	None
Collector						
Collector	at-grade	250 ft.	L/R Turns	100 ft.	¼-½ mile	None
Residential Street						
Residential Street	at-grade	250 ft.	L/R Turns	Access to Each Lot	na	None
Downtown Commercial						
Downtown Commercial	at-grade	250 ft.	L/R Turns	100 ft.	400 ft	None
Alley (Urban)						
Alley (Urban)	at-grade	100 ft.	L/R Turns	Access to Each Lot	na	None

⁽¹⁾For most roadways, at-grade crossings are appropriate.

⁽²⁾Allowed moves and spacing requirements may be more restrictive than those shown to optimize capacity and safety. Any access to a state highway requires a permit from the ODOT District Office. Access will generally not be granted where there is a reasonable alternative access.

⁽³⁾Generally, signals should be spaced to minimize delay and disruptions to through traffic. Signals may be spaced at intervals closer than those shown to optimize capacity and safety and on one-way couplets. Pedestrian crossing is often benefited by a closer intervals of signal placing.

⁽⁴⁾Partial median control allows well-defined and channelized breaks in the physical median barrier between intersections. Use of physical median barriers can be interspersed with segments of continuous left-turn lane, or, if demand is light, no median at all. Medians can be beneficial to crossing pedestrians.

Application

These access management restrictions are generally not intended to eliminate existing intersections or driveways. Rather, they should be applied as new development occurs. Over time, as land is developed and redeveloped, the access to roadways should meet these guidelines. However, where there is a recognized problem, such as an unusual number of collisions, these techniques and standards can be applied to retrofit existing roadways.

To summarize, access management strategies consist of managing the number of access points and providing traffic and facility improvements. The solution is a balanced, comprehensive program that provides reasonable access while maintaining the safety and efficiency of traffic movement.

State Highways

Access management is important to promoting safe and efficient travel for both local and long distance users along US Highway 20 through Philomath. The 1991 Oregon Highway Plan specifies an access management classification system for State facilities. Although Philomath may designate State highways as arterial roadways within their transportation systems, the access management categories for these facilities should generally follow the guidelines of the Oregon Highway Plan. This section of the Transportation System Plan describes the state highway access categories and specific roadway segments where special access areas may apply.

General

Highway 20/34 through Philomath is a state highway of statewide importance. Within the Philomath UGB, Oregon Highway Plan Category 4, "Limited Control"¹ applies the following guidelines:

These highway segments provide for efficient and safe medium-to-high-speed and medium-to-high-volume traffic movements on higher function interregional highway segments. They may also carry significant volumes of longer distance intracity trips. They are appropriate for routes passing through areas that have moderate dependence on the highway to serve land access and where the financial and social costs of attaining full access control would substantially exceed benefits. This category includes a small part of the statewide facilities and most regional facilities.

ODOT's Category 4 policy states that the facility should maintain 500 feet between full-access private drives; 1/4 mile between public roads for urban/urbanizing sections of the highway; and traffic signal spacing of 1/2 mile or greater. Partial control of medians using barriers or raised curbs is provided. This classification permits at-grade intersections or interchanges at a minimum spacing of one-quarter mile.

The Alsea Highway, which borders Philomath's western UGB, is a state highway of district importance. Within the Philomath UGB, Oregon Highway Plan Category 5, "Partial Control"¹ applies the following guidelines:

These highway segments provide for efficient and safe slower-to-medium-speed and low-to-high volume traffic movements on intercity and intercommunity routes. This category will be assigned only where there is little value in providing high speed travel. Providing for reasonable and safe access to abutting property is a major purpose of this access category.

¹ 1991 Oregon Highway Plan, Appendix B, Table 1, Access Management Classification System.

The Category 5 policy states that the facility should maintain 300 feet between full-access private drives; 1/4 mile between public roads for urban/urbanizing sections of highway; and 1/4 mile or greater spacing between traffic signals. Median control is limited.

One-way Highway 20/34 Downtown

While the access management guidelines can be applied to some portions of US Highway 20, the city has an established grid system through the downtown area, with most intersections spaced as closely as 400 feet apart. Neither the general access category for major arterial roadways nor the OHP Category 4 classifications can be practically met on these sections of the roadways. However with the one-way couplet planned for the future the street, traffic signal and access spacing standards for two-way highways are not applicable.

Highway Plan standards are too restrictive for areas with centralized commercial development, such as downtown Philomath. Shorter block lengths and a well-developed grid system are important to a downtown area, along with convenient and safe pedestrian facilities. In general, downtown commercial arterial streets typically have blocks 200 to 400 feet long, driveway access spacing as close as 100 feet, and, occasionally, signals may be spaced as close as every 400 feet. The streets in downtown areas must have sidewalks and crosswalks, along with on-street parking. The need to maintain these typical downtown characteristics must be carefully considered along with the need to maintain the safe and efficient movement of through traffic.

To address this issue, a one-way couplet is recommended along Highway 20/34 from west of 7th Street to east of 19th Street. To accommodate existing public roadway spacing and allow reasonable access spacing for private driveways, less restrictive access standards are recommended for this downtown area. Within the one-way couplet access standards should allow intersection spacing at a minimum of 400 feet, driveway spacing at a minimum of 100 feet (see Table 7-3), and signal spacing as close as 400 feet.

A number of new traffic signals are proposed for construction in the downtown area as part of any one-way couplet alternative that may be implemented in Philomath. With the couplet, signals would be operated at the intersections of Main Street (US 20) with the Alsea Highway (proposed), 9th Street (proposed), 13th Street (existing), 19th Street (existing), and 26th Street (proposed). Spacing between these signals would be approximately 3,000 feet, 1,500 feet, 2,300 feet, and 3,300 feet, respectively. Only two of the signals would comply with the necessary 1/2 mile (2,640 feet) spacing required of two way Category 4 facilities. However, the signals would comply with recommended guidelines for the downtown one-way couplet. Table 7-5 provides signal spacing guidelines that serve to optimize through traffic progression along a two-way arterial corridor based on signal cycle length and arterial travel speed. These guidelines should be observed for two-way highways where possible, realizing that closer spacing may be required to accommodate pedestrian activity or to improve capacity or safety operations. On a one-way street efficient traffic progression isn't dependent on intersection spacing and closer spacing of traffic signals is acceptable. Appropriate traffic signal traffic progression speeds can also be set on one-way couplets whereas can be seen from Table 7-5 two-way streets don't allow for this flexibility.

**TABLE 7-5
OPTIMUM SIGNALIZED INTERSECTION SPACING FOR EFFICIENT TRAFFIC PROGRESSION**

Cycle Length (seconds)	Speed (miles per hour)						
	25	30	35	40	45	50	55
60	1,100 ft	1,320 ft	1,540 ft	1,760 ft	1,980 ft	2,200 ft	2,430 ft
70	1,280 ft	1,540 ft	1,800 ft	2,050 ft	2,310 ft	2,500 ft	2,820 ft
80	1,470 ft	1,760 ft	2,050 ft	2,350 ft	2,640 ft	2,930 ft	3,220 ft
90	1,630 ft	1,980 ft	2,310 ft	2,640 ft	2,970 ft	3,300 ft	3,630 ft
120	2,200 ft	2,640 ft	3,080 ft	3,520 ft	3,960 ft	4,400 ft	4,840 ft
150	2,750 ft	3,300 ft	3,850 ft	4,400 ft	4,950 ft	5,500 ft	6,050 ft

Source: *Technical Guidelines for the Control of Direct Access to Arterial Highways* - Volumes I and II, Federal Highway Administration (FHWA-RD-76-86).

MODAL PLANS

The Philomath modal plans have been formulated using information collected and analyzed through a physical inventory, forecasts, goals and objectives, and input from area residents. The plans consider transportation system needs for Philomath during the next 20 years assuming the growth projections discussed in Chapter 5. The changes in land use patterns and growth of the population will guide the timing for individual improvements in future years. Specific projects and improvement schedules may need to be adjusted depending on when and where growth occurs within Philomath.

Street System Plan

The street system plan recommends changes to the current street classification system and outlines a series of improvements that are recommended for construction within the City of Philomath during the next 20 years. These options have been discussed in Chapter 6 (Improvement Options Analysis). The proposed street system plan is summarized in Table 7-6 and the network is shown in Figure 7-1. In future updates or revisions of this TSP, changes in local zoning adjacent to Highway 20/34 and the designation of a Special Transportation Area (STA) in the downtown may be appropriate for the City to explore.

Truck Routing

Figure 7-4 shows the existing and proposed truck route system for Philomath. In addition to the proposed truck routes shown, trucks would also be expected to use the one-way couplet when constructed and the West Hills Road extension to the Highway 20/34 intersection west of Philomath. It is not expected that either of these projects will be constructed in the near future. Improvements to 13th Street south of Main Street and to Grange Hall Road are included in the following list of street improvement projects and the Benton County Draft TSP.

Street Improvement Projects

Figure 7-5 and Table 7-6 presents street improvement projects that are also included in the street system plan. The projects are listed as short-range high priority (construction expected in the next 0 to 5 years), intermediate range medium priority (construction expected in the next 5 to 10 years), and long range lower priority (construction expected in the next 10 to 20 years). In addition to the projects shown in the following table there were some longer range projects that will be needed in the Philomath area. Figure 7-1 shows street network additions that will provide for street network continuity and will be needed based on expected future travel demands in the Philomath area. The right of way and construction of these street additions should be acquired and accomplished as development occurs.

**TABLE 7-6
RECOMMENDED STREET PROJECTS**

Project Description	Project Location	Project Phasing	Estimated Project Cost
Street Improvement Projects			
Install Traffic Signal	Intersection of US Highway 20 and State Highway 34	Long-Range	\$200,000
Install Traffic Signal	Intersection of Main St. at 9th St..	Intermediate-Range	Incl. in project # 9B cost
Install Traffic Signal	Intersection of Main St. at 26th St..	Long-Range	\$200,000
Bridge Improvement on Grange Hall	Greasy Creek Bridge	Short-Range	\$620,000
Improvements along Grange Hall Rd.	Intersection of Grange Hall Rd. at Fern Rd. (Realign Fern Rd.)	Short-Range	\$200,000
Truck Route Improvements (Street Improvement With Bike Lanes)	13th St. (Between Chapel Dr & Main St.)	Intermediate-Range	\$2,040,000
Access Improvements (Relocate Clemens Mill Rd. across from 26 th	Clemens Mill Rd. and 26 th St. at Highway 20/34	Long-Range	\$850,000
Street Overlay	Highway 20/34 (Between West City Limits and Newton Creek Bridge)	Intermediate-Range	\$730,000
Street Overlay	Grange Hall Rd. (Between Alsea Highway and Fern Rd.)	Intermediate-Range	\$300,000
Street Overlay	Mt. Union Ave. (Between Benton View Dr. and Plymouth Dr.)	Short-Range	\$60,000
Improved street signing in the city	Within City Limits	Short-Range	\$40,000
Widen Streets with Intersection Bulb Outs, Bike Paths and Side Walks	College St. (20 th St. to 12 th St.) and Applegate St. (20 th St. to 11 th St.)	Short-Range	\$3,200,000
One-way Couplet with Additional Capacity Improvements	College/Main/Applegate St. One-Way Couplet along Hwy. 20/34	Intermediate-Range	\$11,900,000
Extend Applegate Rd. over Newton Creek	Between 23rd St. and 24th St.	Short-Range	\$600,000
Extend Newton St. to 26th St.	Between Dead End and 26th St.	Intermediate-Range	\$130,000

The West Hills Road extension to the Highway 20/34 intersection west of Philomath was identified as a project that will be needed after the 20 year planning period for this TSP. The street improvements shown in Table 7-6 will not be adequate to serve expected demand much beyond this 20-year planning period unless the West Hills connection project is also constructed. The West Hills Road connection is shown as a collector road in Figure 7-1 and is expected to have a total cost in the range of \$10,000,000. Based on the public input, including comments from persons on the TTSC, this is a high priority future project to accommodate trucks and the future traffic demands.

Statewide Transportation Improvement Program (STIP) Projects

The Oregon Department of Transportation has a comprehensive transportation improvement and maintenance program encompassing the entire state highway system. The Statewide Transportation Improvement Program (STIP) identifies all the highway improvement projects in Oregon. The STIP lists specific projects, the counties in which they are located, and their construction year.

The final 1998 to 2001 STIP, published in December 1997, identified no major highway improvements scheduled within Philomath's city limits or UGB. One project of local interest that falls just outside Philomath's southern UGB involves replacement of the Greasy Creek Bridge along Grange Hall Road. This structure (ODOT bridge No. 08108) is scheduled for construction in federal fiscal year 1999 at a cost of \$402,000. Replacement of the structure should eliminate current truck load restrictions on the bridge.

Pedestrian System Plan

A sidewalk inventory of major streets revealed that the downtown core of Philomath, primarily excluding Main Street, has fairly intermittent sidewalk coverage, and is generally lacking curb cuts for wheelchair access. Many of the existing roadways outside of the downtown area also lack sidewalks and curb cuts, and where present, sidewalks are generally segmented.

The City has developed, and is in the third year of implementing, a comprehensive ten-year sidewalk development plan to address identified sidewalk deficiencies along roadways under their jurisdiction. Under the plan, all City streets with curb and gutter will be retro-fitted with sidewalks as needed. Completion of the remaining seven years of the plan will result in the addition of approximately 4.1 miles of sidewalks to the existing sidewalk system between 1998 and 2005, significantly improving pedestrian access, safety and connectivity throughout the city. Additionally, the City's subdivision ordinance requires installation of sidewalks for all new development.

The primary goal of the sidewalk development program is to improve pedestrian safety and connectivity; however, an effective sidewalk system has several qualitative benefits as well. Providing adequate pedestrian facilities increases the livability of a city. When pedestrians can walk on a sidewalk, separated from vehicular street traffic, it makes the walking experience more enjoyable and may encourage walking, rather than driving, for short trips. Sidewalks enliven a downtown and encourage leisurely strolling and window shopping in commercial areas. This "Main Street" effect improves business for downtown merchants and provides opportunities for friendly interaction among residents. It may also have an appeal to tourists as an inviting place to stop and walk around.

To fund the sidewalk development program, the City has a long-standing city ordinance (ordinance No. 608) requiring all affected property owners to install and maintain, at owner expense, concrete sidewalks adjacent to and abutting city streets with curb and gutter. The resulting cost to the City is therefore nothing as the cost is passed on to property owners. Although this is what the ordinance says, the City is not enforcing it, and may want

to consider this as a funding option. However, the City may need or choose to fund certain projects up front and establish conditions of repayment with property owners. For property owners, the cost will vary based on lot size and location. Typical residential properties will need to install sidewalks 5-feet wide while properties in all business and commercial zones will need to construct sidewalks 10-feet wide. A typical unit cost for 5-foot wide concrete sidewalks over two inches of aggregate is \$30 per linear foot. Roughly double this number to \$60 per linear foot for 10-foot wide sidewalks.

The City should ensure that their sidewalk design standards are compliant with Americans with Disabilities (ADA) requirements (e.g., provide curb cuts at intersection crossings for wheelchair access). Additionally, the City should expand sidewalk coverage to all paved City roads in accordance with proposed street design standards presented previously in this Chapter. (these standards are still being developed).

By developing those multi-use path projects identified in the Philomath Master Bike Path and Trails Plan and further recommended under the Pedestrian Modal Plan element of this TSP, the City will significantly improve pedestrian safety and access to many of the community's valued resources including parks, schools, and scenic areas such as the Mary's River. Access to popular destinations in Corvallis, such as Avery Park, will also be expanded. The character of multi-use paths supports safe and leisurely use by people of all ages. These paths are not intended to replace the need for a safe and connective system of sidewalks and bike paths along the surrounding street system. Rather, the multi-use path supplements these facilities.

Recommended multi-use path improvement projects are located on a map in Figure 7-6. Table 7-7 contains a list of specific multi-use path pedestrian improvements that will be needed over the next 20 years. Sidewalks should be added as new streets are constructed and existing streets reconstructed.

**TABLE 7-7
RECOMMENDED PEDESTRIAN IMPROVEMENT PROJECTS**

Pedestrian Improvement Projects	Project Location	Project Phasing	Estimated Cost
Multi-Use Path	South 13th St. across Frolic/Rodeo grounds to Mary's River.	Short-Range	\$150,000
Multi-Use Path	Fern Rd. paralleling Mary's River across to Alsea Hwy.	Long-Range	\$320,000
Multi-Use Path	Extend Central bike path to South 19th St.	Intermediate-Range	\$200,000

In addition to these projects it is critical for future pedestrian mobility and safety to incorporate appropriate pedestrian design features in other projects. This is particularly important for highway projects with heavy traffic volumes. A complete list of pedestrian crossing strategies that may be applicable are included in Appendix F. Two important example strategies for future highway design are curb extensions and raised medians discussed as follows.

Curb Extensions

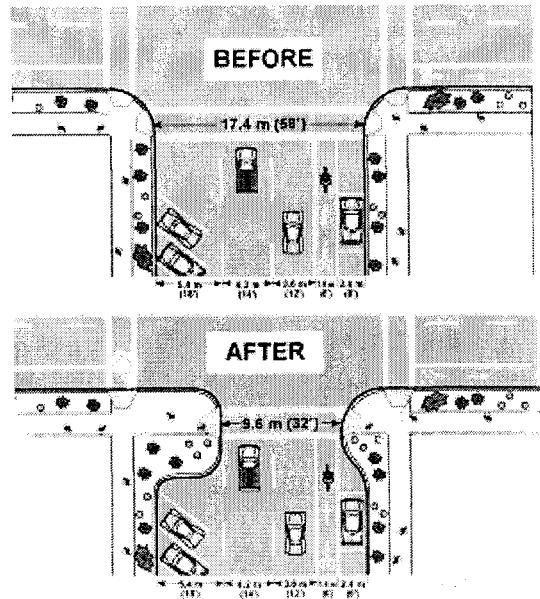

Figure 7-7: Curb extensions reduce crossing distance.

Also known as "bulbs, neckdowns, flares or chokers," curb extensions reduce the pedestrian crossing distance and improve the visibility of pedestrians by motorists. Curb extensions should be considered at all intersections where on-street parking is allowed. The crossing distance savings are greatest when used on streets with diagonal parking. On arterials and collectors, space should be provided for existing or planned bike lanes.

Reducing pedestrian crossing distance improves signal timing if the pedestrian phase controls the signal. The speed normally used for calculating pedestrian crossing time is 1.2 m (4 ft)/sec., or less where many older pedestrians are expected. The time saved is substantial when two corners can be treated with curb extensions.

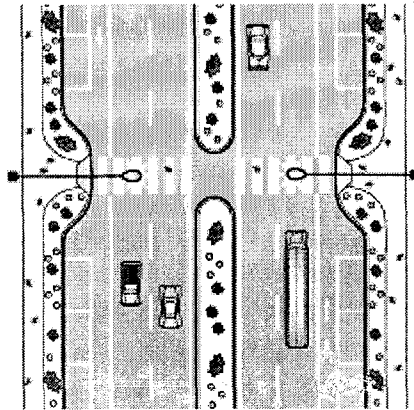

Figure 7-8: Mid-block curb extension with median and illumination

Non-signalized intersections also benefit from curb extensions: reducing the time pedestrians are in a crosswalk improves pedestrian safety and vehicle movement.

Mid-block crossing curb extensions may be considered where there are current or anticipated pedestrian generating land uses on both sides of the road (see section A.1.b. Land Use).

Raised Medians

These benefit pedestrians on two-way, multi-lane streets, as they allow pedestrians to cross only one direction of traffic at a time: it takes much longer to cross four lanes of traffic than two. Where raised medians are used for access management, they should be constructed so they provide a pedestrian refuge.

Where it is not possible to provide a continuous raised median, island refuges can be created between intersections and other accesses. These should be located across from high pedestrian generators such as schools, parks, municipal buildings, parking lots, etc.

In most instances, the width of the raised median is the width of the center turn-lane, minus the necessary shy distance on each side. Ideally, raised medians should be constructed with a smooth, traversable surface, such as brick pavers. Medians should be landscaped with the plants low enough so they do not obstruct visibility, and spaced far enough apart to allow passage by pedestrians.

Bicycle System Plan

The goal of the city's Master Philomath Bike Path and Trails Plan is to, "link parks, open spaces, schools, and residential areas via a system of trails and bike paths." Projects supporting this goal should reduce conflicts between bicyclists and motorized vehicle traffic, develop a system dedicated to bicycles, and provide opportunities for recreational bicycle use. The City's bike plan identifies seven projects that build upon the existing system of bike lanes, multi-use paths, shoulder bikeways, and shared roadway facilities already in use in Philomath. These

projects would substantially improve the interconnection of parks, open spaces, schools, and residential areas in and around the Philomath community.

Shared roadways, where bicyclists share normal vehicle lanes with motorists, are generally acceptable if speeds and traffic volumes are relatively low. On the local streets in Philomath, shared roadways are not an issue; however, on collector and arterial roadways, bike lanes are recommended.

**TABLE 7-8
RECOMMENDED BICYCLE PROJECTS**

Bicycle Improvement Projects	Project Location	Project Phasing	Estimated Cost
Add Bike Lanes "Striped and Signed"	College/Applegate Couplet Alignment (Between West/East UGB Limits)	Intermediate-Range	Incl. in project # B cost
Add Bike Lanes "Striped and Signed"	South 19th St. (between College St. and Chapel Dr.)	Short-Range	\$320,000
Add Bike Route "Signed"	Southwood Dr./30th St./Applegate St to 26th St.	Short-Range	\$5,000
Add directional 6-foot multi-use paths	Chapel Dr. (between 13th St. Bellfountain Rd.)	Intermediate-Range	\$820,000
Add Bike Lanes "Striped and Signed"	13th St. (Between Chapel Dr. and Main St.)	Intermediate-Range	Incl. in project # 5B cost
Stripe and Sign Existing Roadway for Bike Lanes	Applegate St. (between proposed couplet and 26th St.)	Intermediate-Range	\$5,000
Add Bike Lanes "Striped and Signed"	West Hills Rd. (between Wyatt Lane and 19th St.)	Long-Range	\$770,000
Short Range (Next 5 Years)			\$325,000
Intermediate Range (5-10 Years)			\$1,595,000
Long Range (10-20 Years)			\$770,000
Total			\$2,690,000

Highway 20/34 functions as an arterial street through Philomath, which means that it should have bike lanes on both sides of the street as required by the TPR. Accident statistics on the highway do not indicate that there are frequent conflicts between bicyclists and motorized vehicles in Philomath. To install bicycle lanes along Highway 20/34 would involve removing on-street parking through downtown Philomath. Shoulders would need widening on sections where no on-street parking exists. Some of these improvements would be expensive and others would be controversial. At the present time, no specific bikeway improvements are recommended for Highway 20/34; however, bicycle lanes are recommended as part of the future one-way couplet project.

Bicycle parking is generally lacking in Philomath. Bike racks should be installed in front of downtown businesses and all public facilities (schools, post office, library, city hall, and parks). Typical rack designs cost about \$50 per bike plus installation. An annual budget of approximately \$1,500 to \$2,000 should be established so that Philomath can begin to place racks where needs are identified and to respond to requests for racks at specific locations.

Transportation Demand Management Plan

Through transportation demand management (TDM), peak travel demands can be reduced or spread to more efficiently use the transportation system, rather than building new or wider roadways. Techniques that have been successful and could be initiated to help alleviate some traffic congestion include carpooling and vanpooling, alternative work schedules, bicycle and pedestrian facilities, and programs focused on high density employment areas.

In Philomath, where traffic volumes are relatively low and the population and employment is small, implementing TDM strategies is not practical in most cases. However, the sidewalk and bikeway improvements recommended earlier in this chapter are also considered TDM strategies. By providing these facilities, the City of Philomath is encouraging people to travel by other modes than the automobile. In rural communities, TDM strategies include providing mobility options.

Because intercity commuting is a factor in Benton County, residents who live in Philomath and work in other cities, such as Corvallis, should be encouraged to carpool with a fellow coworker or someone who works in the same area. Implementing a local carpool program in Philomath alone may not be practical because of the city's small size; however, a countywide carpool program or intercity carpool program with Corvallis is possible. The City of Philomath should support state and county carpooling and vanpooling programs that could further boost carpooling ridership.

No costs have been estimated for the TDM plan. Grants may be available to set up programs; other aspects of Transportation Demand Management can be encouraged through ordinance and policy.

Public Transportation Plan

Local public transportation in Philomath consists of Dial-A-Bus service for senior citizens and the disabled. There is also several other on demand services available to the disadvantaged in Benton County. Regional service is provided in Corvallis by the Valley Retriever and Greyhound at Albany. The Valley Retriever has three round trips daily between Newport, Philomath, Corvallis and Albany.

Intercity connections and senior citizen and disabled public transportation should be maintained and increased usage of these services should be encouraged. Bus stops should also be considered as part of the proposed one-way couplet improvement project.

The city has no local fixed-route transit service at this time. The small size and low traffic volumes on city streets indicate that mass transit is neither necessary nor economically feasible at this time. The Transportation Planning Rule exempts cities of less than population 25,000 from developing a transit system plan or a transit feasibility study as part of their TSPs. However, Philomath is expected to be part of a combined Corvallis/Philomath metropolitan planning area (MPO) in the next several years when the area population exceeds 50,000 people. It is expected that the fixed route transit service may be provided in Philomath during the next 20 years by the Corvallis Transit System. This would be expected to start after the area becomes a MPO with further development in the west Corvallis area and Philomath can plan for future transit services with growth patterns that support rather than discourage transit use in the future.

The existing Valley Retriever line and Dial-A-Bus services already meet the required daily trip to a larger city specified for communities the size of Philomath in the Oregon Transportation Plan.

No costs have been estimated for this modal plan. A Linn/Benton Transit Feasibility Study is currently being conducted. It is expected that this study will result in recommending any needed transit projects in Philomath in the next 20 years. If there are Philomath transit projects identified as part of the feasibility study, the projects should be included in the next update of this Philomath TSP.

Rail Service Plan

The nearest available passenger rail service is the Amtrak service located in the city of Albany. Although there has been considerable discussion of regular passenger rail service to Philomath it has not been found to be economically feasible by the current railroad operator and is not included in this plan.

The Willamette & Pacific Railroad provides daily rail service to Philomath. Freight service is provided west to Toledo, east to Corvallis and north and south from Corvallis. With the recent crossing improvements the tracks are in good condition and it is anticipated that class 2 standards may be met (30 mph) in Philomath. There are two projects needed within the 20-year planning period for this plan. A short-term project to provide siding and spur tracks at the Georgia Pacific mill is included in this plan.

The other needed project is an intermodal freight transfer station. This is a long-range project expected to cost approximately \$1,000,000. There has been considerable discussion about where to locate the intermodal transfer station and it appears that the most feasible location may be south of Corvallis instead of in the Philomath area. The wet lands in the remaining industrial areas and the topography in the northwestern sections of Philomath would not be feasible locations for a transfer station. Since this facility would most likely be located outside the Philomath UGB it is not included in the costs for the Philomath TSP.

**TABLE 7-9
RECOMMENDED RAILROAD SYSTEM PROJECTS**

Location	Project	Project Phasing/Priority	Cost
Georgia Pacific Mill	Delivery siding and spur tracks	Short-Range/High	\$250,000
South of Corvallis	Intermodal Freight Transfer Station	Long-Range/Medium	\$1,000,000
Subtotal High Priority Projects			\$250,000
Subtotal Medium Priority Projects			\$1,000,000
Subtotal Low Priority Projects			
TOTAL COST (Philomath TSP)			\$250,000

Note: The Freight Transfer Station project will most likely be outside the UGB and is not included in the Total Cost

Air Service Plan

The Corvallis Municipal Airport is located approximately 5 miles southeast of Philomath. There are no commercial flights to the airport at this time. The nearest commercial air service with regularly scheduled flights is in Eugene. Shuttle service to the Portland International Airport is available from Corvallis. Future needs and

conditions are appropriately addressed as part of the City of Corvallis plans (TSP and Corvallis Municipal Airport Master Plan).

Pipeline Service Plan

There are currently no significant pipelines serving Philomath.

Water Transportation Plan

Philomath has no waterborne transportation services.

TRANSPORTATION SYSTEM PLAN IMPLEMENTATION PROGRAM

Implementation of the Philomath Transportation System Plan will require both changes to the city comprehensive plan and zoning code and preparation of a 20-Year Capital Improvement Plan. These actions will enable Philomath to address both existing and emerging transportation issues throughout the urban area in a timely and cost effective manner.

The Capital Improvement Plan (CIP) is discussed as part of the next chapter titled Funding Options and Financial Plan. The purpose of the CIP is to detail what transportation system improvements will be needed as Philomath grows and provide a process to fund and schedule the identified transportation system improvements. It is expected that the Transportation System Plan Capital Improvement Plan can be integrated into the existing city CIP the Benton County CIP and the ODOT STIP. This integration is important since the Transportation System Plan proposes that all three governmental agencies will fund some of the transportation improvement projects. A complete list of the recommended projects for this transportation system plan is included in Table 7-10.



(NOT TO SCALE)

Not in the 20 Year Planning Horizon

LEGEND:

- URBAN GROWTH BOUNDARY
- CITY LIMITS
- ===== MAJOR ARTERIAL
- MINOR ARTERIAL
- ===== COLLECTOR STREET
- ===== LOCAL STREET
- NEW LOCAL STREET
- FUTURE COLLECTOR STREET
- ⊕ EXISTING TRAFFIC SIGNAL
- ⊗ FUTURE TRAFFIC SIGNAL

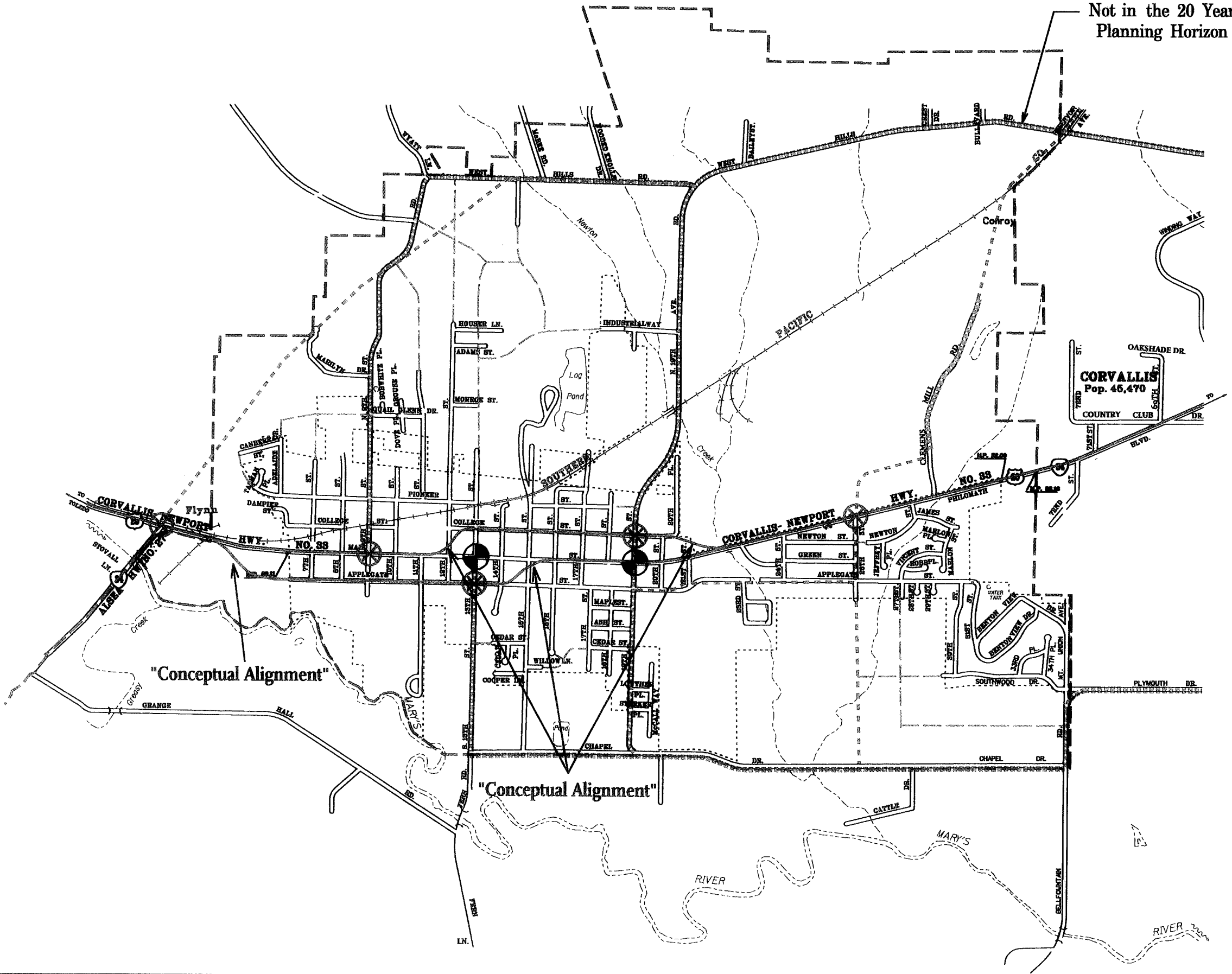

FIGURE 7-1

Future Street Classifications and Traffic Signals

ODOT0254/FIG7-1.DGN/JXD/11-19-98



(NOT TO SCALE)

LEGEND:

- U.G.B. LINE
- CITY LIMITS
- ▬ EXISTING TRUCK ROUTE
- ▬ PROPOSED TRUCK ROUTE

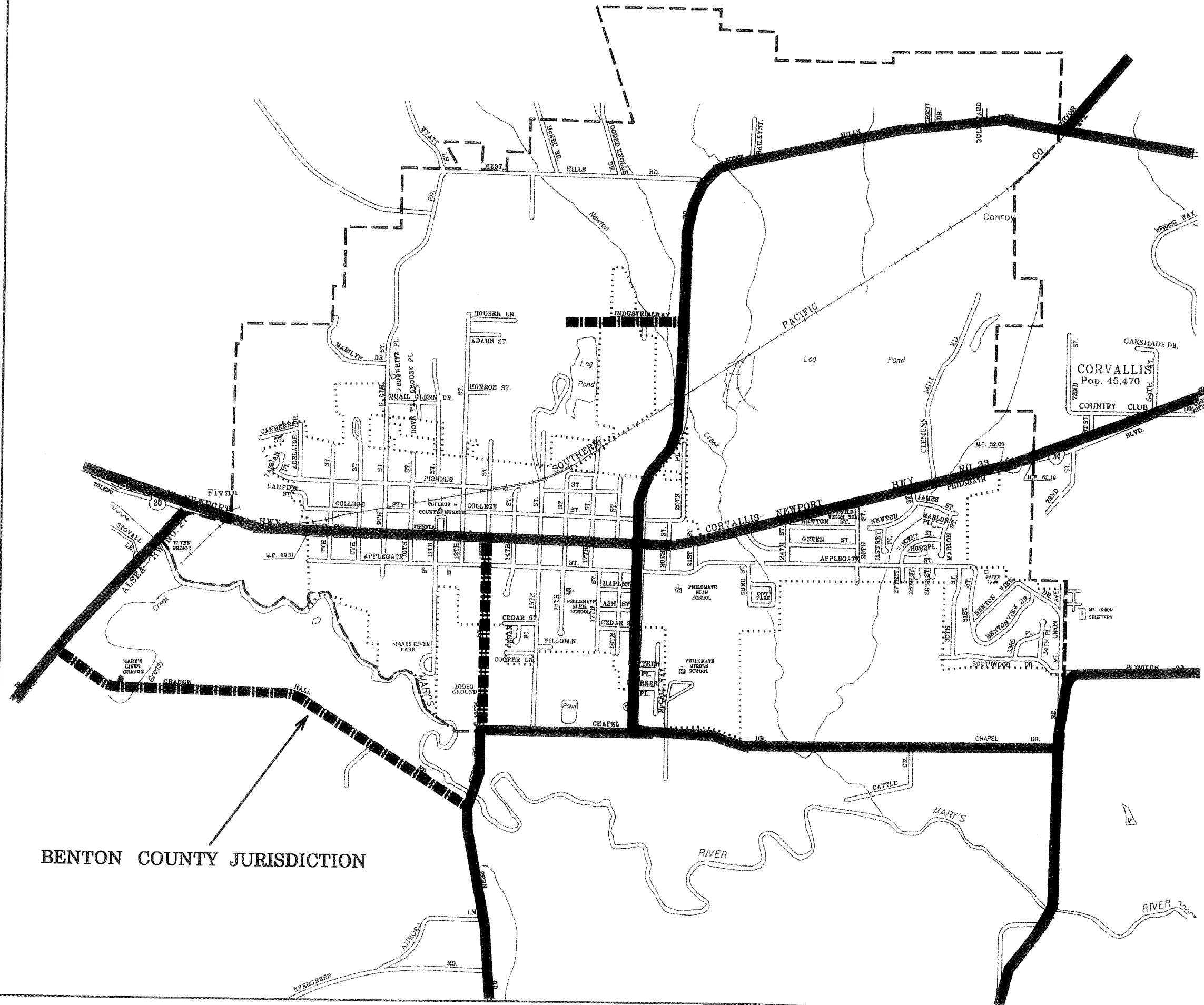

BENTON COUNTY JURISDICTION

FIGURE 7-4

Proposed Truck Route System



(NOT TO SCALE)

LEGEND:

- U.G.B. LINE
- CITY LIMITS

① PROJECT NUMBER

● PROJECT LOCATION FOR STREET OR INTERSECTION IMPROVEMENT

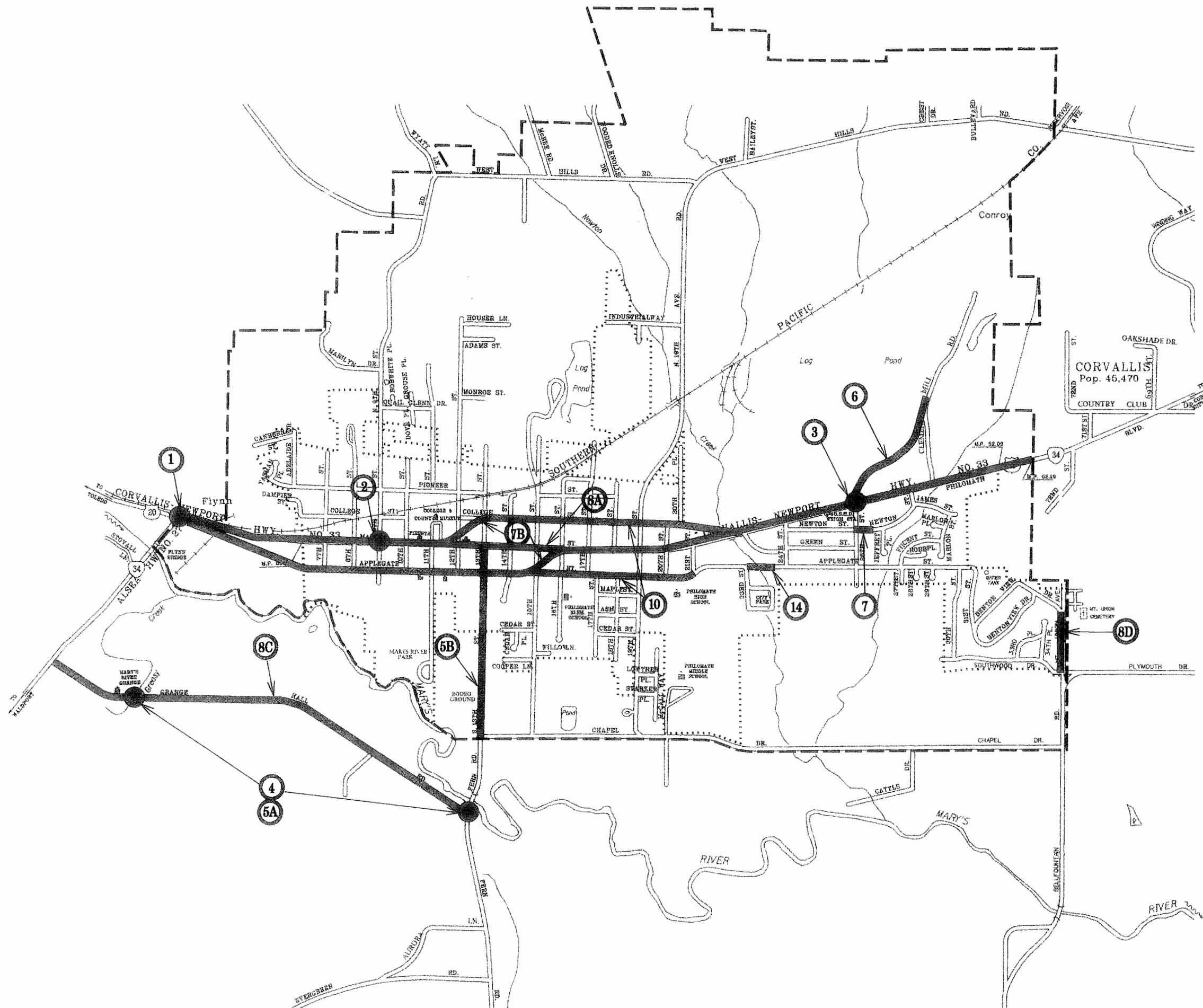

FIGURE 7-5

Recommended Street and Intersection Improvement Projects



(NOT TO SCALE)

LEGEND:

- URBAN GROWTH BOUNDARY
- CITY LIMITS

EXISTING

- BIKE LANES *STRIPED AND SIGNED*
- SHOULDER BIKEWAY
- MULTI-USE PATH

RECOMMENDED

- ⓑ1 BIKE OR PEDESTRIAN IMPROVEMENT PROJECT NUMBER
- BIKE LANES *STRIPED AND SIGNED*
- MULTI-USE PATH

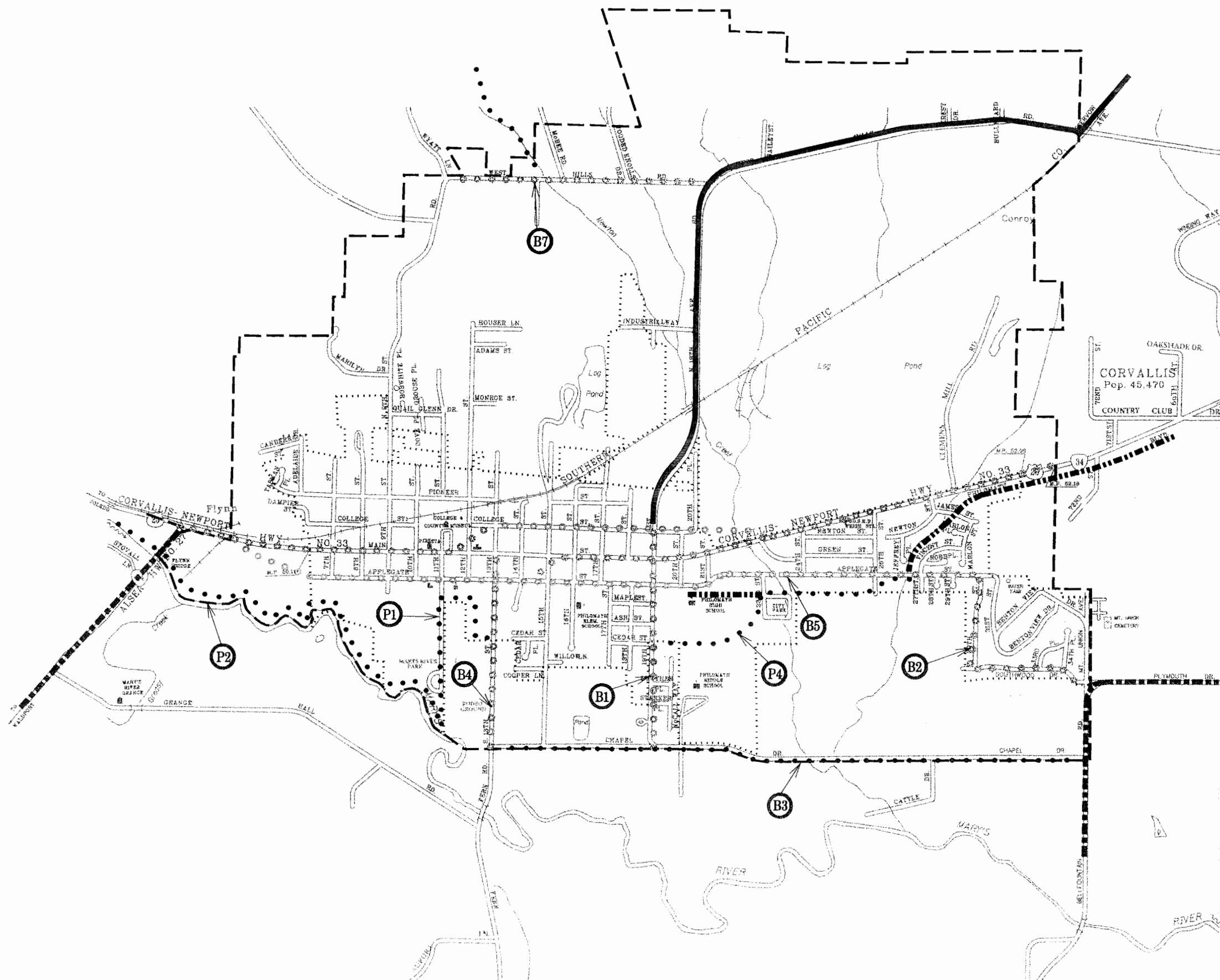

ODOT0254/FIG7-5.DGN/TNT/06-07-98

FIGURE 7-6

Recommended Bicycle and Pedestrian Improvement Projects

CHAPTER 8: FUNDING OPTIONS AND FINANCIAL PLAN

The Transportation Planning Rule requires Transportation System Plans to evaluate the funding environment for recommended improvements. This evaluation must include a listing of all recommended improvements, estimated costs to implement those improvements, a review of potential funding mechanisms, and an analysis of existing sources' ability to fund proposed transportation improvement projects. Philomath's TSP identifies nearly \$24 million in 27 specific projects over the next 20 years. This section of the TSP provides an overview of Philomath's revenue outlook and a review of some funding and financing options that may be available to the City of Philomath to fund the improvements.

Pressures from increasing growth throughout much of Oregon have created an environment of estimated improvements that remain unfunded. Philomath will need to work with Benton County and ODOT to finance the potential new transportation projects over the 20-year planning horizon. The actual timing of these projects will be determined by the rate of population and employment growth actually experienced by the community. This TSP assumes Philomath and neighboring communities will grow at a rate comparable to past growth, consistent with the countywide growth forecast, and that the resulting traffic will increase as anticipated. If the population and traffic growth exceeds this rate, the improvements may need to be accelerated. Slower than expected growth will relax the improvement schedule.

HISTORICAL STREET IMPROVEMENT FUNDING SOURCES

In Oregon, state, county, and city jurisdictions work together to coordinate transportation improvements. Table 8-1 shows the distribution of road revenues for the different levels of government within the state by jurisdiction level. Although these numbers were collected and tallied in 1991, ODOT estimates that these figures accurately represent the current revenue structure for transportation-related needs.

**TABLE 8-1
SOURCES OF ROAD REVENUES BY JURISDICTION LEVEL**

Revenue Source	Jurisdiction Level			All Funds
	State	County	City	
State Road Trust	58%	38%	41%	48%
Local	0%	22%	55%	17%
Federal Road	34%	40%	4%	30%
Other	9%	0%	0%	4%
Total	100%	100%	100%	100%

Source: ODOT 1993 Oregon Road Finance Study.

At the state level, nearly half (48 percent in Fiscal Year 1991) of all road-related revenues are attributable to the State Highway Fund (State Road Trust), whose sources of revenue include fuel taxes, weight-mile taxes on trucks, and vehicle registration fees. As shown in the table, the state road trust is a considerable source of revenue for all levels of government. Federal sources (generally the Federal Highway Trust account and Federal Forest revenues) comprise another 30 percent of all road-related revenue. The remaining sources of road-related revenues are generated locally, including property taxes, LIDs, bonds, traffic impact fees, road user taxes, general fund transfers, receipts from other local governments, and other sources.

As a state, Oregon generates 94 percent of its highway revenues from user fees, compared to an average of 78 percent among all states. This fee system, including fuel taxes, weight distance charges, and registration fees, is regarded as equitable because it places the greatest financial burden upon those who create the greatest need for road maintenance and improvements. Unlike many states that have indexed user fees to inflation, Oregon has static road-revenue sources. For example, rather than assessing fuel taxes as a percentage of price per gallon, Oregon's fuel tax is a fixed amount (currently 24 cents) per gallon.

Transportation Funding in Benton County

Historically, sources of road revenues for Benton County have included federal grants, state revenues, intergovernmental transfers, interest from the working fund balance, and other sources. Transportation revenues and expenditures for Benton County are shown in Table 8-2 and Table 8-3.

**TABLE 8-2
BENTON COUNTY TRANSPORTATION-RELATED REVENUES**

	1994-1995	1995-1996	1996-1997	1997-1998
	Actual	Actual	Budget	Budget
Cash on Hand	\$976,971	\$873,066	\$1,497,689	\$1,728,050
Revenues				
Fees	\$128,513	\$265,874	\$285,677	\$207,898
Unrestricted funds and taxes		\$242,500		
Other unrestricted	\$70,846	\$100,322	\$73,518	\$97,312
Program-dedicated funds				
Intergovernmental services	\$117,505	\$132,071	\$113,599	\$187,029
Highway apportionment	\$2,955,080	\$3,049,842	\$2,946,717	\$2,989,711
Federal forest revenues	\$266,351	\$257,178	\$247,643	\$237,777
Federal Aid- Secondary System	\$329,001	\$907	\$413,160	\$231,562
FEMA		\$208,767	\$60,571	\$84,735
Capital Improvements	\$225,329	\$233,011	\$193,662	\$22,747
Other dedicated funds	\$119,044	\$46,049	\$144,347	\$39,839
	\$4,211,669	\$4,536,521	\$4,478,894	\$4,098,610

Source: Benton County.

As shown in Table 8-2, revenues have remained relatively stable (between \$4 and \$4.5 million). Approximately \$3 million of the annual revenues come from the State Highway Fund. A declining amount has come from Federal Forest receipts. Twenty-five percent of Federal Forest revenue (the 25-percent fund) is returned to the counties based on their share of the total acreage of Federal Forests. Westside National Forests in Oregon and Washington are subject to the Spotted Owl Guarantee, which limits the decline of revenues from these forests to three percent annually. Oregon Forests under the Owl Guarantee include the Deschutes, Mount Hood, Rogue River, Siskiyou, Siuslaw, Umpqua, and Willamette National Forests. Forest revenues distributed to Benton County are from the Siuslaw forest, subject to the Owl Guarantee.

**TABLE 8-3
BENTON COUNTY TRANSPORTATION-RELATED EXPENDITURES**

	1994-1995	1995-1996	1996-1997	1997-1998
	Actual	Actual	Budget	Budget
General Service & Administration	\$460,581	\$421,474	\$391,837	\$409,930
General Engineering Services	\$601,725	\$593,098	\$607,846	\$661,177
Road Maintenance	\$2,571,000	\$2,485,083	\$2,411,778	\$2,564,655
Road Overlay Projects	\$392,150	\$179,229	\$643,108	\$443,870
Spot Improvements	\$39,299		\$299	
Capital Improvements	\$124,812	\$166,854	\$171,095	\$625
	\$4,189,567	\$3,424,264	\$3,834,126	\$3,670,327

Source: Benton County.

As shown in Table 8-3, Benton County categorizes its expenditures into the following categories: general service and administration, general engineering services, road maintenance, road overlay projects, spot improvements, and capital improvements. As shown in the table, the county has spent between \$125,000 and \$170,000 annually in capital improvements, with significantly less money budgeted for capital improvements in the 1997-1998 budget year. The bulk of expenditures in the road fund are for services relating to road maintenance.

Historical Revenues and Expenditures in the City of Philomath

Revenues and expenditures for the City of Philomath's Street Fund are shown Table 8-4 and Table 8-5. Sources of revenues available for street operations and maintenance include the State Highway Fund, interest from the working capital balance, and grants for specific projects.

**TABLE 8-4
CITY OF PHILOMATH STREET FUND REVENUES**

	1994-95	1995-96	1996-97	1997-98	1998-99
	Actual	Actual	Actual	Budget	Budget
Combined Cash Balance	\$64,475	\$9,119	\$48,586	\$52,000	
Revenue					
Storm Drain Grant				\$15,000	
Downtown Grant				\$200,000	
Urban Renewal Expense Reimbursable			\$132,000	\$354,200	
State Highway Tax	\$139,516	\$147,754	\$143,876	\$153,285	\$160,000
Bikepath Apportionment	\$1,409	\$1,492	\$1,454	\$1,533	
Oil Mat. Reimbursement	\$2,238				
Interest on Investments	\$(3)	\$704	\$3,147	\$3,000	
Misc. Revenue	\$1,438	\$18,496	\$30,095		\$57,000
Transfer from General Fund	\$24,000	\$10,000		\$6,000	\$37,000
	\$168,598	\$178,446	\$310,572	\$733,018	\$254,000

Source: The City of Philomath

As shown in Table 8-4, funds from the State Highway Fund provide a large proportion (over 90 percent excluding grant funds) of the revenues available to the City of Philomath's Street Fund. The City of Philomath has benefited from several recent grants, including a \$15,000 storm drain grant, and a \$200,000 downtown grant.

**TABLE 8-5
CITY OF PHILOMATH STREET FUND EXPENDITURES**

	1994-95	1995-96	1996-97	1997-98	1998-99
	Actual	Actual	Actual	Budget	Budget
Personal Services	\$67,860	\$59,906	\$61,033	\$66,118	\$74,884
Downtown Improvement Grant				\$200,000	\$195,150
Pave South 11th Street	\$40,625				
Materials and Services	\$129,023	\$75,589	\$102,284	\$107,442	\$151,116
Urban Renewal Area Improvement				\$132,000	\$354,200
Other Capital Outlay	\$19,833	\$1,208		\$5,000	
Transfers	\$5,000	\$4,500	\$19,000	\$45,000	\$20,039
	\$262,341	\$141,203	\$182,317	\$555,560	\$795,389

Source: City of Philomath

Most of the Street Fund expenditures are for maintenance, with spending disaggregated to the following categories: personal services, materials and services, capital outlay and transfers. The largest categories have historically been personal services and materials and services. The capital outlay expenditures have been limited to small amounts (\$1,200 to \$20,000 annually over grant funds) in recent years. The street fund has also transferred some resources to the general fund to cover a portion of administration costs.

Transportation Revenue Outlook in the City of Philomath

ODOT's policy section recommends certain assumptions in the preparation of transportation plans. In its Financial Assumptions document prepared in May 1998, ODOT projected the revenue of the State Highway Fund through year 2020. The estimates are based on not only the political climate, but also the economic structure and conditions, population and demographics, and patterns of land use. The latter is particularly important for state-imposed fees because of the goals in place under Oregon's Transportation Planning Rule (TPR) requiring a 10-percent reduction in per-capita vehicle miles of travel (VMT) in Metropolitan Planning Organizations (MPO) areas by year 2015, and a 20-percent reduction by year 2025. This requirement will affect the 20-year revenue forecast from the fuel tax. ODOT recommends the following assumptions:

- Fuel tax increases of one cent per gallon per year (beginning in year 2002), with an additional one cent per gallon every fourth year;
- Vehicle registration fees would be increased by \$10 per year in 2002, and by \$15 per year in year 2012;
- Revenues will fall halfway between the revenue-level generated without TPR and the revenue level if TPR goals were fully met;
- Revenues will be shared among the state, counties, and cities on a "50-30-20 percent" basis rather than the previous "60.05-24.38-15.17 percent" basis; and
- Inflation occurs at an average annual rate of 3.6 percent (as assumed by ODOT).

Figure 8-1 shows the forecast in both current-dollar and inflation-deflated constant (1998) dollars. As highlighted by the constant-dollar data, the highway fund is expected to grow slower than inflation early in the planning horizon until fuel-tax and vehicle-registration fee increases occur in year 2002, increasing to a rate somewhat faster than inflation through year 2015, continuing a slight decline through the remainder of the planning horizon.

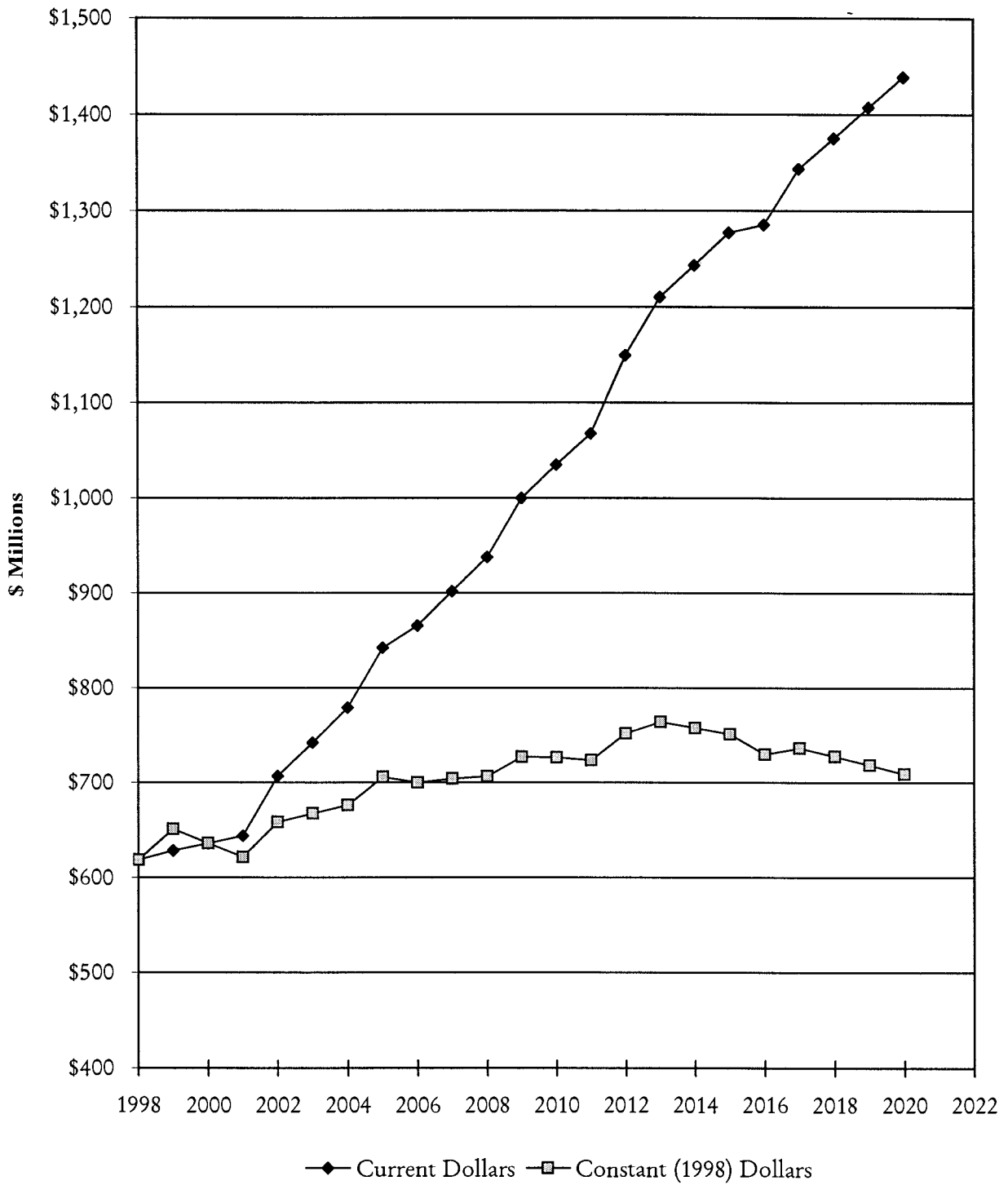

Source: Oregon Department of Transportation

FIGURE 8-1

State Highway Fund
(in Millions of Dollars)

As the State Highway Fund is expected to remain a significant source of funding for Philomath, the City is highly susceptible to changes in the State Highway Fund. As discussed earlier, funds from the State Highway Fund provide a large proportion of the revenues available to the City of Philomath's Street Fund.

In order to analyze the City's ability to fund the recommended improvements from current sources, DEA applied the following assumptions:

- ODOT State Highway Fund assumptions as outlined above;
- The State Highway Fund will continue to account for the majority of the City's Street Fund;
- Interest and other local sources continue to provide stable revenue streams; and
- The proportion of revenues available for capital expenditures for street improvements will remain a stable proportion of the state tax resources.

Applying these assumptions to the estimated level of the State Highway Fund resources, as recommended by ODOT, resources available to the Philomath for all operations, maintenance, and capital outlay purposes are estimated at approximately \$140,000 to \$170,000 annually (in current 1998 dollars), as shown in Table 8-6.

**TABLE 8-6
ESTIMATED RESOURCES AVAILABLE TO CITY OF PHILOMATH
FROM STATE HIGHWAY FUND, 1998 DOLLARS**

Year	Total Estimated Resources from State Highway Fund	Estimated Funds Available for Capital Outlay
1999	\$146,000	\$8,500
2000	\$142,700	\$8,300
2001	\$139,400	\$8,100
2002	\$147,700	\$8,600
2003	\$149,700	\$8,700
2004	\$151,700	\$8,900
2005	\$158,300	\$9,300
2006	\$157,000	\$9,200
2007	\$157,900	\$9,200
2008	\$158,500	\$9,300
2009	\$163,100	\$9,500
2010	\$163,000	\$9,500
2011	\$162,300	\$9,500
2012	\$168,700	\$9,900
2013	\$171,400	\$10,000
2014	\$170,000	\$9,900
2015	\$168,500	\$9,800
2016	\$163,700	\$9,600
2017	\$165,200	\$9,700
2018	\$163,200	\$9,500
2019	\$161,200	\$9,400
2020	\$159,100	\$9,300

The amount actually received from the State Highway Fund will depend on a number of factors, including:

- the actual revenue generated by state gasoline taxes, vehicle registration fees, and other sources; and
- the population growth in Philomath (since the distribution of State Highway Funds is based on an allocation formula which includes population).

Based on the amount of resources historically available to fund capital improvements this analysis suggests that the City of Philomath will have between \$8,000 and \$10,000 available annually for capital improvements.

REVENUE SOURCES

In order to finance the recommended transportation system improvements requiring expenditure of capital resources, it will be important to consider a range of funding sources. Although the property tax has traditionally served as the primary revenue source for local governments, property tax revenue goes into general fund operations, and is typically not available for street improvements or maintenance. Despite this limitation, the use of alternative revenue funding has been a trend throughout Oregon as the full implementation of Measures 5 and 47 has significantly reduced property tax revenues (see below). The alternative revenue sources described in this section may not all be appropriate in Philomath; however, this overview is being provided to illustrate the range of options currently available to finance transportation improvements during the next 20 years.

Property Taxes

Property taxes have historically been the primary revenue source for local governments. However, property tax revenue goes into general fund operations, and is not typically available for street improvements or maintenance. The dependence of local governments on this revenue source is due, in large part, to the fact that property taxes are easy to implement and enforce. Property taxes are based on real property (i.e., land and buildings) which has a predictable value and appreciation to base taxes upon. This is as opposed to income or sales taxes that can fluctuate with economic trends or unforeseen events.

Property taxes can be levied through: 1) tax base levies, 2) serial levies, and 3) bond levies. The most common method uses tax base levies, which do not expire and are allowed to increase by six percent per annum. Serial levies are limited by amount and time they can be imposed. Bond levies are for specific projects and are limited by time based on the debt load of the local government or the project.

The historic dependence on property taxes is changing with the passage of Ballot Measure 5 in the early 1990s. Ballot Measure 5 limits the property tax rate for purposes other than payment of certain voter-approved general obligation indebtedness. Under full implementation, the tax rate for all local taxing authorities is limited to \$15 per \$1,000 of assessed valuation. As a group, all non-school taxing authorities are limited to \$10 per \$1,000 of assessed valuation. All tax base, serial, and special levies are subject to the tax rate limitation. Ballot Measure 5 requires that all non-school taxing districts' property tax rate be reduced if together they exceed \$10 per \$1,000 per assessed valuation by the county. If the non-debt tax rate exceeds the constitutional limit of \$10 per \$1,000 of assessed valuation, then all of the taxing districts' tax rates are reduced on a proportional basis. The proportional reduction in the tax rate is commonly referred to as compression of the tax rate.

Measure 47, an initiative petition, was passed by Oregon voters in November 1996. It is a constitutional amendment that reduces and limits property taxes and limits local revenues and replacement fees. The measure limits 1997-98 property taxes to the lesser of the 1995-96 tax minus 10 percent, or the 1994-95 tax. It limits future

annual property tax increases to three percent, with exceptions. Local governments' lost revenue may be replaced only with state income tax, unless voters approve replacement fees or charges. Tax levy approvals in certain elections require 50 percent voter participation.

The state legislature created Measure 50, which retains the tax relief of Measure 47 but clarifies some legal issues. This revised tax measure was approved by voters in May 1997.

The League of Oregon Cities (LOC) estimated that direct revenue losses to local governments, including school districts, will total \$467 million in fiscal year 1998, \$553 million in 1999, and increase thereafter. The actual revenue losses to local governments will depend on actions of the Oregon Legislature. LOC also estimates that the state will have revenue gains of \$23 million in 1998, \$27 million in 1999, and increase thereafter because of increased personal and corporate tax receipts due to lower property tax deduction.

Measure 50 adds another layer of restrictions to those which govern the adoption of tax bases and levies outside the tax base, as well as Measure 5's tax rate limits for schools and non-schools and tax rate exceptions for voter approved debt. Each new levy and the imposition of a property tax must be tested against a longer series of criteria before the collectible tax amount on a parcel of property can be determined.

System Development Charges

System Development Charges (SDCs) are becoming increasingly popular in funding public works infrastructure needed for new local development. Generally, the objective of systems development charges is to allocate portions of the costs associated with capital improvements upon the developments, which increase demand on transportation, sewer or other infrastructure systems.

Local governments have the legal authority to charge property owners and/or developers fees for improving the local public works infrastructure based on projected demand resulting from their development. The charges are most often targeted towards improving community water, sewer, or transportation systems. Cities and counties must have specific infrastructure plans in place that complies with state guidelines in order to collect SDCs.

Typically, the fee is collected when new building permits are issued. Transportation SDCs are based on trip generation of the proposed development. Residential calculations would be based on the assumption that a typical household will generate a given number of vehicle trips per day.

Nonresidential use calculations are based on employee ratios for the type of business or industrial uses. The SDC revenues would help fund the construction of transportation facilities necessitated by new development. A key legislative requirement for charging SDCs is the link between the need for the improvements and the developments being charged. In compliance with the state requirements, Philomath has a Street CIP and SDC methodology document in place. This document stipulates the maximum street SDC at \$1,147 per dwelling unit based on an estimated construction cost budget for August 1996.

State Highway Fund

Gas tax revenues received from the State of Oregon are used by all counties and cities to fund street and road construction and maintenance. In Oregon, the State collects gas taxes, vehicle registration fees, overweight/overheight fines and weight/mile taxes and returns a portion of the revenues to cities and counties through an allocation formula. The revenue share to cities is divided among all incorporated cities based on

population. Like other Oregon cities, the City of Philomath uses its state gas tax allocation to fund street construction and maintenance.

Local Gas Taxes

The Oregon Constitution permits counties and incorporated cities to levy additional local gas taxes with the stipulation that the moneys generated from the taxes will be dedicated to street-related improvements and maintenance within the jurisdiction. At present, only a few local governments (including the cities of Woodburn and The Dalles, and Multnomah and Washington Counties) levy a local gas tax. The City of Philomath may consider raising its local gas tax as a way to generate additional street improvement funds. However, with relatively few jurisdictions exercising this tax, an increase in the cost differential between gas purchased in Philomath and gas purchased in neighboring communities may encourage drivers to seek less expensive fuel elsewhere. Any action will need to be supported by careful analysis to minimize the unintended consequences of such an action.

Vehicle Registration Fees

The Oregon Vehicle Registration Fee is allocated to the state, counties and cities for road funding. Oregon counties are granted authority to impose a vehicle registration fee covering the entire county. The Oregon Revised Statutes would allow Benton County to impose a biannual registration fee for all passenger cars licensed within the County. Although both counties and special districts have this legal authority, vehicle registration fees have not been imposed by local jurisdictions. A disincentive to employing such a fee may be the cost of collection and administration. In order for a local vehicle registration fee program to be viable in Benton County, all the incorporated cities and the county would need to formulate an agreement which would detail how the fees would be spent on future street construction and maintenance.

Local Improvement Districts

The Oregon Revised Statutes allow local governments to form Local Improvement Districts (LIDs) to construct public improvements. LIDs are most often used by cities to construct localized projects such as streets, sidewalks or bikeways. The statutes allow formation of a district by either the city government or property owners. Cities that use LIDs are required to have a local LID ordinance that provides a process for district formation and payback provisions. Through the LID process, the cost of local improvements are generally spread out among a group of property owners within a specified area. The cost can be allocated based on property frontage or other methods such as traffic trip generation. The types of allocation methods are only limited by the Local Improvement Ordinance. The cost of LID participation is considered an assessment against the property which is a lien equivalent to a tax lien. Individual property owners typically have the option of paying the assessment in cash or applying for assessment financing through the city. Since the passage of Ballot Measure 5, cities have most often funded local improvement districts through the sale of special assessment bonds.

GRANTS AND LOANS

There are a variety of grant and loan programs available, most with specific requirements relating to economic development or specific transportation issues, rather than for the general construction of new streets. Many programs require a match from the local jurisdiction as a condition of approval. Because grant and loan programs

are subject to change as well as statewide competition, they should not be considered a secure long-term funding source for Philomath. Most of the programs available for transportation projects are funded and administered through ODOT and/or the Oregon Economic Development Department (OEDD). Some programs which may be appropriate for the Philomath are described below. See Appendix G.

Bike-Pedestrian Grants

By law (ORS 366.514), all road street or highway construction or reconstruction projects must include facilities for pedestrians and bicyclists, with some exceptions. ODOT's Bike and Pedestrian Program administers two programs to assist in the development of walking and bicycling improvements: local grants, and Small-Scale Urban Projects. Cities and counties with projects on local streets are eligible for local grant funds. An 80 percent state/20 percent local match ratio is required. Eligible projects include curb extensions, pedestrian crossings and intersection improvements, shoulder widening and restriping for bike lanes. Projects on urban state highways with little or no right-of-way taking and few environmental impacts are eligible for Small-Scale Urban Project Funds. Both programs are limited to projects costing up to \$100,000. Projects that cost more than \$100,000 require the acquisition of right-of-way, or have environmental impacts should be submitted to ODOT for inclusion in the STIP.

Enhancement Program

This federally funded program earmarks \$8 million annually for projects in Oregon. Projects must demonstrate a link to the intermodal transportation system, compatibility with approved plans, and local financial support. A 10.27 percent local match is required for eligibility. Each proposed project is evaluated against all other proposed projects in its region. Within the five Oregon regions, the funds are distributed on a formula based on population, vehicle miles traveled, number of vehicles registered and other transportation-related criteria. The solicitation for applications was mailed to cities and counties the last week of October 1998. Local jurisdictions have until January 1999 to complete and file their applications for funding available during the 2000-2003 fiscal years, which begin October 1999.

Highway Bridge Rehabilitation or Replacement Program

The Highway Bridge Rehabilitation or Replacement Program (HBRR) provides federal funding for the replacement and rehabilitation of bridges of all functional classifications. A portion of the HBRR funding is allocated for the improvement of bridges under local jurisdiction. A quantitative ranking system is applied to the proposed projects based on sufficiency rating, cost factor, and load capacity. They are ranked against other projects statewide, and require state and local matches of 10 percent each. It includes the Local Bridge Inspection Program and the Bridge Load Rating Program.

Transportation Safety Grant Program

Managed by ODOT's Transportation Safety Section (TSS), this program's objective is to reduce the number of transportation-related accidents and fatalities by coordination a number of statewide programs. These funds are intended to be used as seed money, funding a program for three years. Eligible programs include programs in impaired driving, occupant protection, youth, pedestrian, speed, enforcement, bicycle and motorcycle safety. Every year, TSS produces a Highway Safety Plan that identifies the major safety programs, suggests counter

measures to existing safety problems, and lists successful projects selected for funding, rather than granting funds through an application process.

Special Transportation Fund

The Special Transportation Fund (STF) awards funds to maintain, develop, and improve transportation services for people with disabilities and people over 60 years of age. Financed by a two-cent tax on each pack of cigarettes sold in the state, the annual distribution is approximately \$5 million. Three-quarters of these funds are distributed to mass transit districts, transportation districts, and where such districts do not exist, counties, on a per-capita formula. The remaining funds are distributed on a discretionary basis.

Special Small City Allotment Program

The Special Small City Allotment Program (SCA) is restricted to cities with populations under 5,000 residents. Unlike some other grant programs, no locally funded match is required for participation. Grant amounts are limited to \$25,000 and must be earmarked for surface projects (drainage, curbs, sidewalks, etc.). However, the program does allow jurisdictions to use the grants to leverage local funds on non-surface projects if the grant is used specifically to repair the affected area. Criteria for the \$1 million in total annual grant funds include traffic volume, the five-year rate of population growth, surface wear of the road, and the time since the last SCA grant.

Immediate Opportunity Grant Program

The Oregon Economic Development Department (OEDD) and ODOT collaborate to administer a grant program designed to assist local and regional economic development efforts. The program is funded to a level of approximately \$7 million per year through state gas tax revenues. The following are primary factors in determining eligible projects:

- Improvement of public roads;
- Inclusion of an economic development-related project of regional significance;
- Creation or retention of primary employment; and
- Ability to provide local funds (50/50) to match grant.

The maximum amount of any grant under the program is \$500,000. Local governments which have received grants under the program include: Washington County, Multnomah County, Douglas County, the City of Hermiston, Port of St. Helens, and the City of Newport.

Oregon Special Public Works Fund

The Special Public Works Fund (SPWF) program was created by the 1995 State Legislature as one of several programs for the distribution of funds from the Oregon Lottery to economic development projects in communities throughout the state. The program provides grant and loan assistance to eligible municipalities primarily for the construction of public infrastructure which support commercial and industrial development that result in permanent job creation or job retention. To be awarded funds, each infrastructure project must support businesses wishing to locate, expand, or remain in Oregon. SPWF awards can be used for improvement, expansion, and new construction of public sewage treatment plants, water supply works, public roads, and transportation facilities.

While SPWF program assistance is provided in the form of both loans and grants, the program emphasizes loans in order to assure that funds will return to the state over time for reinvestment in local economic development infrastructure projects. Jurisdictions that have received SPWF funding for projects that include some type of transportation-related improvement include the cities of Baker City, Bend, Cornelius, Forest Grove, Madras, Portland, Redmond, Reedsport, Toledo, Wilsonville, Woodburn, and Douglas County.

Oregon Transportation Infrastructure Bank

The Oregon Transportation Infrastructure Bank (OTIB) program is a revolving loan fund administered by ODOT to provide loans to local jurisdictions (including cities, counties, special districts, transit districts, tribal governments, ports, and state agencies). Eligible projects include construction of federal-aid highways, bridges, roads, streets, bikeways, pedestrian accesses, and right-of-way costs. Capital outlays such as buses, light-rail cars and lines, maintenance yards and passenger facilities are also eligible.

ODOT FUNDING OPTIONS

The State of Oregon provides funding for all highway related transportation projects through the Statewide Transportation Improvement Program (STIP) administered by the Oregon Department of Transportation. The STIP outlines the schedule for ODOT projects throughout the State. The STIP, which identifies projects for a three-year funding cycle, is updated on an annual basis. Starting with the 1998 budget year, ODOT will then identify projects for a four-year funding cycle. In developing this funding program, ODOT must verify that the identified projects comply with the Oregon Transportation Plan (OTP), ODOT Modal Plans, Corridor Plans, local comprehensive plans, and TEA-21 planning requirements. The STIP must fulfill federal planning requirements for a staged, multi-year, statewide, intermodal program of transportation projects. Specific transportation projects are prioritized based on federal planning requirements and the different State plans. ODOT consults with local jurisdictions before highway related projects are added to the STIP.

The highway-related projects identified in Philomath's TSP will be considered for future inclusion on the STIP. The timing of including specific projects will be determined by ODOT based on an analysis of all the project needs within Region 2. The City of Philomath, Benton County, and ODOT will need to communicate on an annual basis to review the status of the STIP and the prioritization of individual projects within the project area. Ongoing communication will be important for the city, county, and ODOT to coordinate the construction of both local and state transportation projects.

ODOT also has the option of making some small highway improvements as part of their ongoing highway maintenance program. Types of road construction projects that can be included within the ODOT maintenance programs are intersection realignments, additional turn lanes, and striping for bike lanes. Maintenance related construction projects are usually done by ODOT field crews using state equipment. The maintenance crews do not have the staff or specialized road equipment needed for large construction projects.

An ODOT funding technique that will likely have future application to Philomath's TSP is the use of state and federal transportation dollars for off-system improvements. ODOT has the authority and ability to fund transportation projects that are located outside the boundaries of the highway corridors. The criteria for determining what off-system improvements can be funded has not yet been clearly established. It is expected that this new funding technique will be used to finance local system improvements that reduce traffic on state highways or reduce the number of access points for future development along state highways.

Financing Tools

In addition to funding options, the recommended improvements listed in this plan may benefit from a variety of financing options. Although often used interchangeably, the words financing and funding are not the same. Funding is the actual generation of revenue by which a jurisdiction pays for improvements, some examples include the sources discussed above: property taxes, SDCs, fuel taxes, vehicle registration fees, LIDs, and various grant programs. In contrast, financing refers to the collecting of funds through debt obligations.

There is a number of debt financing options available to the City of Philomath. The use of debt to finance capital improvements must be balanced with the ability to make future debt service payments and to deal with the impact on its overall debt capacity and underlying credit rating. Again, debt financing should be viewed not as a source of funding, but as a time shifting of funds. The use of debt to finance these transportation-system improvements is appropriate since the benefits from the transportation improvements will extend over the period of years. If such improvements were to be tax financed immediately, a large short-term increase in the tax rate would be required. By utilizing debt financing, local governments are essentially spreading the burden of the costs of these improvements to more of the people who are likely to benefit from the improvements and lowering immediate payments.

General Obligation Bonds

General obligation (GO) bonds are voter-approved bond issues which represent the least expensive borrowing mechanism available to municipalities. GO bonds are typically supported by a separate property tax levy specifically approved for the purposes of retiring debt. The levy does not terminate until all debt is paid off. The property tax levy is distributed equally throughout the taxing jurisdiction according to assessed value of property. GO debts typically are used to make public improvement projects that will benefit the entire community.

State statutes require that the GO indebtedness of a city not exceed three percent of the real market value of all taxable property in the city. Since GO bonds would be issued subsequent to voter approval, they would not be restricted to the limitations set forth in Ballot Measures 5, 47, and 50. Although new bonds must be specifically voter approved, Measure 47 and 50 provisions are not applicable to outstanding bonds, unissued voter-approved bonds, or refunding bonds.

Limited Tax Bonds

Limited tax general obligation (LTGO) bonds are similar to general obligation bonds in that they represent an obligation of the municipality. However, a municipality's obligation is limited to its current revenue sources and is not secured by the public entity's ability to raise taxes. As a result, LTGO bonds do not require voter approval. However, since the LTGO bonds are not secured by the full taxing power of the issuer, the limited tax bond represents a higher borrowing cost than GO bonds. The municipality must pledge to levy the maximum amount under constitutional and statutory limits, but not the unlimited taxing authority pledged with GO bonds. Because LTGO bonds are not voter approved, they are subject to the limitations of Ballot Measures 5, 47, and 50.

Bancroft Bonds

Under Oregon Statute, municipalities are allowed to issue Bancroft bonds which pledge the city's full faith and credit to assessment bonds. As a result, the bonds become general obligations of the city but are paid with

assessments. Historically, these bonds provided a city with the ability to pledge its full faith and credit in order to obtain a lower borrowing cost without requiring voter approval. However, since Bancroft bonds are not voter approved, taxes levied to pay debt service on them are subject to the limitations of Ballot Measures 5, 47, and 50. As a result, since 1991, Bancroft bonds have not been used by municipalities who were required to compress their tax rates.

FUNDING REQUIREMENTS

Philomath's TSP identifies capital improvements recommended during the next 20 years to address safety and access problems and to expand the transportation system to support a growing population and economy. The TSP identifies 27 projects, totaling nearly \$24 million. Seven of the projects, including the couplet improvements estimated to cost nearly \$12 million, have been identified to be state-led projects. An additional nine projects are expected to receive county-led financial support. The balance of the projects, estimated to cost nearly \$1.3 million, are under the city's jurisdiction.

Estimated costs by project are shown in Table 8-7.

TABLE 8-7
RECOMMENDED TRANSPORTATION IMPROVEMENT PROJECTS LIST
CAPITAL IMPROVEMENT PROGRAM
CITY OF PHILOMATH

Proj No.	Project Location	Project Phasing	State	County	City	Railroad	Estimated Project Cost
Street Improvement Projects							
1	Traffic Signal at Intersection of US Highway 20 and State Highway 34	Long-Range	\$200,000				\$200,000
2	Traffic Signal at Intersection of Main St. at 9th St.	Intermediate-Range	incl. in # 10 cost				incl. in # 10 cost
3	Traffic Signal at Intersection of Main St. at 26th	Long-Range	\$200,000				\$200,000
4	Bridge Improvement on Grange Hall Rd. at Greasy Creek Bridge	Short-Range		\$620,000			\$620,000
5A	Improvements along Grange Hall Rd. at Fern Rd. (Realign Fern Rd.)	Short-Range		\$200,000			\$200,000
5B	Truck Route Improvements at 13th St. (Between Chapel Dr. and Main St.)	Intermediate-Range		\$2,040,000			\$2,040,000
6	Access Improvements at Clemens Mill Rd. and 26th St. at Hwy. 20/34	Long-Range	\$850,000				\$850,000
7A	Highway 20/34 (Between West City Limits and Newton Creek Bridge) Overlay	Intermediate-Range	\$730,000				\$730,000
7B	College Street (20th to 12th) Overlay	Short-Range	incl. in # 9 cost			incl. in # 9 cost	incl. in # 9 cost
7C	Grange Hall Rd. (Between Alsea Highway and Fern Rd.) Overlay	Intermediate-Range		\$300,000			\$300,000
7D	Mt. Union Ave. (Between Benton View Dr. and Plymouth Dr.) Overlay	Short-Range		\$60,000			\$60,000
8	Signing Within City Limits	Short-Range			\$40,000		\$40,000
9	College St.(20th St. to 12th St.) and Applegate St.(20th St. to 11th St.) Street Widening	Short-Range	\$2,880,000		\$320,000		\$3,200,000
10	One-Way Couplet Improvements Along Hwy. 20/34 Using College/Main/Applegate Streets	Intermediate-Range	\$11,900,000				\$11,900,000
12	Extend Applegate Rd. over Newton Creek Between 23rd St. and 24th St.	Short-Range	\$540,000		\$60,000		\$600,000
16	Extend Newton St. to 26th St. Between Dead End and 26th St.	Intermediate-Range			\$130,000		\$130,000
Bicycle Improvement Projects							
B2	Add Bike Lanes at College/Applegate Couplet Alignment (Between West/East UGB Limits)	Intermediate-Range	incl. in # 10 cost				incl. in # 10 cost
B6	Add Bike Lanes at South 19th St. (between College St. and Chapel Dr.)	Short-Range		\$320,000			\$320,000
B7	Add Bike Lanes at Southwood Dr./30th St./Applegate st. to 26th St.	Short-Range			\$5,000		\$5,000
B8	Add Multi-Use Paths at Chapel Dr. (between 13th St. and Bellfountain Rd.)	Intermediate-Range		\$820,000			\$820,000
B9	Add Bike Lanes at 13th St. (Between Chapel Dr. and Main St.)	Intermediate-Range		incl. in # 5B cost			incl. in # 5B cost
B10	Restripe Applegate St. (between proposed couplet and 26th St.)	Intermediate-Range			\$5,000		\$5,000
B12	Add Bike Lanes at West Hills Rd. (between Wyatt Ln. and 19th St.)	Long-Range		\$770,000			\$770,000
Pedestrian Improvement Projects							
P1	South 13th St. Multi-Use Paths across Frolic/Rodeo grounds to Mary's River	Intermediate-Range			\$150,000		\$150,000
P2	Fern Rd. Multi-Use Paths paralleling Mary's River across to Alsea Hwy	Long-Range			\$320,000		\$320,000
P4	Extend Central bike path to South 19th St.	Intermediate-Range			\$200,000		\$200,000
Rail Projects							
R1	Willamette & Pacific Railroad at Georgia Pacific South of Corvallis/Philomath area	Short-Range Long-Range				\$250,000	\$250,000
Transit, Rail, Air, Water, and Pipeline Projects							
	Future projects should be added from the						
	Short-Range Subtotal		\$3,420,000	\$1,200,000	\$425,000	\$250,000	\$5,295,000
	Intermediate-Range Subtotal		\$12,630,000	\$3,160,000	\$485,000	\$0	\$16,275,000
	Long-Range Subtotal		\$1,250,000	\$770,000	\$320,000	\$0	\$2,340,000
	Total		\$17,300,000	\$5,130,000	\$1,230,000	\$250,000	\$23,910,000

The City of Philomath is expected to be able to fund projects of up to approximately \$190,000 in the 20-year planning horizon. Based on current revenue sources for the City of Philomath and the improvements identified in this Transportation System Plan, the City would face a funding deficit of over \$1 million as shown in TABLE 8-8.

TABLE 8-8
ESTIMATED CAPITAL FUNDING BALANCE

	Years 0-5	Years 6-10	Years 11-20
Available from existing sources	\$42,200	\$45,900	\$106,300
Needed for city-funded projects	\$425,000	\$485,000	\$320,000
Surplus (Deficit)	\$(382,800)	\$(439,100)	\$(213,700)
Cumulative Surplus (Deficit)	\$(382,800)	\$(821,900)	\$(1,035,600)

Given the existing cost estimates, the resources available as estimated in Table 8-6, and financial partners currently identified, Philomath is expected to experience a funding deficit of over \$1 million over the 20-year planning period. However, some of the projects may be eligible for alternative funding sources. For example, the extension of Applegate Street over Newton Creek (project 12) may qualify for HBRR funding, which provides federal funding for up to 80 percent of a bridge replacement or rehabilitation as described above. Also, projects which serve to enhance the pedestrian connectivity of the city, may potentially be eligible for bike and pedestrian funding. These projects include the multi-use paths on South 13th Street (project P1), Fern Road (P2), and Central Road (P3), and the bikeway projects on Southwood Drive (project B7) and Applegate Street (B10). Estimated to total \$680,000, grant funds for these projects would serve to allow Philomath to implement these projects within the 20-year planning horizon. Additionally, some of the projects may be necessitated by new development, thereby making them eligible for SDC funding. Additional analysis and an update to Philomath's Streets CIP and SDC methodology document would be required to evaluate the feasibility of this funding option.

This transportation system plan identifies 27 projects recommended over the next 20 years. Based on existing revenue sources and the estimated costs to implement the improvements, the City of Philomath is expected to experience a budget shortfall of over \$1 million over the 20-year planning horizon. The City will need to work with Benton County and ODOT to explore alternative funding sources, including the Federal Enhancement Program, bike and pedestrian grants, HBRR, and other programs described in this chapter, to implement the recommended improvements.

APPENDIX A
PLANNING AND PERFORMANCE GUIDELINES

APPENDIX A

PLANNING AND PERFORMANCE GUIDELINES

The Planning and Performance Guidelines below help implement the OTP by providing a structure for further transportation planning and programming for regional and local agencies. Achievement of these guidelines is considered necessary to carry out the Oregon Transportation Plan. The guidelines will operate in conjunction with the Transportation Rule, which already specifies planning considerations and procedures to be applied to regions or urban places of different sizes. The role of the OTP planning guidelines is to supplement but not replace already established requirements of the Transportation Rule and the federal ISTEA.

To assist regional and local government consistency with the Oregon Transportation Plan, the following outline suggests the type of jurisdiction to which OTP policies and actions apply. These guidelines assume that the OTP action statements associated with policies are an integral part of the goals and policies of the plan. The Minimum Levels of Service standards are intended to be implemented during the next 20 years by federal, state, regional and local governments and the private sector.

I. All Jurisdictions

A. Policy Guidelines

The following Policy Guidelines apply to all MPOs and local governments:

1. Provide a balanced transportation system. (Policy 1A)
 - a. Design systems and facilities that accommodate multiple modes within corridors where appropriate. (Action 1A.1)
2. Preserve corridors for future transportation development. (Action 1B.4)
3. Promote a transportation system that is reliable and accessible to all potential users measured by availability of modal choices, ease of use, relative cost, proximity to service and frequency of service. (Policy 1C)

- a. Provide transportation services in compliance with the Americans with Disabilities Act (ADA) requirements for all modes and transfer facilities. (Actions 1C.3)
 - b. Assure that services of private and public transportation providers are coordinated. (Action 1C.5)
4. Provide a transportation system that is environmentally responsible and encourages conservation of natural resources. (Policy 1D)
 - a. Minimize transportation-related energy consumption through improved vehicle efficiencies, use of clean burning motor fuels, and increased use of fuel efficient modes which may include railroads, transit, carpools, vanpools, bicycles and walking. (Action 1D.1)
 - b. Positively affect both the natural and built environments in the design, construction and operation of the transportation system. Where adverse impacts cannot be avoided, minimize or mitigate their effects on the environment. (Action 1D.3)
 - c. Cooperate with state and local agencies which regulate air quality, water quality, energy conservation, noise abatement, and transportation of hazardous materials. (Actions 1D.2, .4, .5, .6, and .7)
 5. Provide a transportation system with connectivity among modes within and between urban areas, with ease of transfer among modes and between local and state transportation systems. (Policy 1F)
 - a. In local and regional transportation plans, identify (a) major transportation terminals and facilities, and (b) routes and modes connecting passenger and freight facilities with major highways and intermodal facilities. (Action 1F.1)
 6. Promote the safety of the transportation system.
 - a. Cooperate with state agencies to target resources to dangerous routes and locations. (Action 1G.4)
 - b. Increase cooperation with other governments and private enterprises to implement effective community-based safety programs. (Action 1G.6)
 - c. Build, operate, and regulate the transportation system so that users feel safe and secure as they travel. (Action 1G.9)
 7. Develop transportation plans and policies that implement Oregon's statewide planning goals. (Policy 2A)
 - a. Support local land use planning with transportation plans that provide the needed level of mobility while minimiz-

- ing automobile miles traveled and number of automobile trips taken per capita. (Action 2A.1)
- b. Develop transportation system plans sufficient to accommodate planned development. (Action 2A.2)
 - c. Restrict access from state facilities for incompatible activities and development where land use plans call for rural or resource developments. (Action 2A.6)
8. Provide for interurban mobility through and near urban areas in a manner which minimizes adverse effects on land use and urban travel patterns. (Policy 2C)
 - a. In transportation system plans and land use plans, avoid dependence on the state highway system for direct access to commercial, residential, or industrial development adjacent to the state highway. (Action 2C.3)
 9. Promote safe, comfortable travel for pedestrians and bicyclists along travel corridors and within existing communities and new developments. (Policy 2D)
 10. Encourage modal alternatives to the automobile and truck where feasible in rural areas. (Action 2F.3)
 11. Protect and enhance the aesthetic value of transportation corridors in order to support economic development and preserve quality of life. (Policy 2H)
 12. Provide more efficient railroad service through the reduction of conflicts at busy railroad crossings and rail yard areas by means such as grade separations and development of alternative motor vehicle circulation routes. (Action 3A.5)
 13. Provide a direct, convenient, and physically suitable system for goods movement to transportation facilities and commercial and industrial areas to ensure the timely delivery of goods. (Action 3B.1)
 14. Develop a transportation system that supports tourism and improves access to recreational destinations. (Policy 3E)
 - a. Incorporate tourist facilities and services that are identified in a state tourism plan in the local transportation plan. (Action 3E.1)
 15. Manage effectively existing transportation infrastructure and services before adding new facilities. (Policy 4G)
 - a. Protect the integrity of statewide transportation corridors and facilities from encroachment by such means as controlling access to state highways, minimizing rail crossings and controlling incompatible land use around airports. (Action 4G.4)

16. Coordinate transportation projects and activities involving federal lands agencies with those agencies. (Action 2A.5 and Policy 4L)
17. Establish private sector participation in transportation policy and systems plans. (Action 4M.1)
18. Develop programs that ensure the opportunity for citizens, businesses and state agencies to be involved in all phases of the transportation planning processes. (Policy 4N)
 - a. Make information about proposed transportation policies, plans and programs available to the public in an understandable form. (Action 4N.2)
19. Accommodate international, interstate and statewide movements of goods and passengers that move through the jurisdiction.

B. Minimum Levels of Service

In cooperation with state government, MPOs and local governments should

1. Coordinate intercity elderly and disadvantaged services with intercity bus and van services which are open to the general public.
2. Connect intercity bus services to local transit and elderly and disadvantaged services.
3. Preserve priority railroad rights of way for potential public use or ownership when abandonment proceedings are initiated.
4. Encourage and support reload facilities where they provide the most cost efficient and environmentally efficient and effective response to branchline abandonment.

APPENDIX B
MASTER PHILOMATH BIKE PATH AND TRAIL PLAN



MASTER PHILOMATH BIKE PATH AND TRAILS PLAN

February 28, 1994

GOAL is to link parks, open spaces, schools, and residential areas via a system of trails and bike paths.

Note The term "bike path" includes bike lanes, bike ways, bike paths, etc

Proposed system would make use of interconnected loops so as to provide various lengths for walks and biking.

The present system has three bike paths that connect Corvallis and Philomath

- 1 Country Club Road to U.S. 20 to Philomath
- 2 North 53rd Street to Reservoir Road to West Hills Road to 19th Street ending at College Street.
- 3 Plymouth Road from 53rd Street to Bellfountain Road ending at intersection with Mt. Union and Southwood Drive

PLAN

- 1 Extend central bike path from Corvallis (#1 above) from Applegate Street and South 26th Street south to city limits, then west to City Park/Philomath High School to South 19th Street
- 2 Extend northern bike path (#2 above) from North 19th and College Streets south along South 19th Street to Chapel Road (Requires widening and other improvements on South 19th Street)
- 3 Extend southern bike path (#3 above) east from Plymouth Road along Southwood Drive, 30th Street, and Applegate Street to connect with #1
 - Urge County to add bike path along Chapel Road from Bellfountain Road to Fern Road (South 13th Street)

4. Add bike path to South 13th Street from Applegate Street south to Chapel Road.
5. Improve and extend North 12th or North 13th from Main Street to West Hills Road. Include bike path.
 - Alternately, improve 9th Street adding bike path from Main Street to West Hills Road.
6. Connect bike path on South 13th Street across Frolic and Rodeo grounds and Marys River Park to the Marys River.
7. Provide trail and/or bike path along the Marys River from Fern Road to Woods Creek to join with proposed section of the Corvallis-to-the-Sea Trail.
8. Provide trail and bike path from West Hills Road north to the Benton County Open Space Park to connect to proposed Corvallis-to-the-Sea Trail.
9. Add bike lane(s) to U.S. 20/OR 34.
10. Provide bike lane(s) along Applegate Street from 26th Street to 11th Street.

**APPENDIX C
POTENTIAL ISSUES TO BE ADDRESSED IN THE TSP**

**COMMENTS REGARDING POTENTIAL
ISSUES TO BE ADDRESSED**

**SITE SPECIFIC IMPROVEMENTS
AND NEEDS QUESTIONNAIRE RESPONSES**

APPENDIX C

**TABLE C-1
POTENTIAL ISSUES TO BE ADDRESSED IN THE TSP
Newsletter (N) and Open House Questionnaire (Q) Responses**

	Very important 1				2				3				4				Not important 5			
	N	%	Q	%	N	%	Q	%	N	%	Q	%	N	%	Q	%	N	%	Q	%
Improvements in overall traffic circulation	9	41	8	57	7	32	1	7	3	14	5	36	1	5	0	0	2	9	0	0
Couplet connections	12	60	5	36	3	15	2	14	1	5	3	21	0	0	1	7	4	20	3	21
Design of couplet to avoid separating the community	5	29	2	14	5	29	2	14	2	12	4	29	1	6	4	29	4	24	2	14
Improvements to pedestrian access across Main Street and in the downtown commercial area	9	41	2	17	7	32	5	42	4	18	3	25	1	5	2	17	1	5	0	0
Neighborhood traffic issues, e.g., dangerous intersections, speeding, etc.	7	33	8	53	4	19	4	27	6	29	2	13	2	6	1	7	2	10	0	0
Additional or improved arterial or collector streets to accommodate future growth	6	33	6	40	3	17	6	40	5	28	3	20	3	17	0	0	1	6	0	0
Control of access points to Highway 20/34	5	32	1	8	5	26	8	62	4	21	2	15	2	11	1	8	2	11	1	8
Separation of truck traffic through downtown	9	47	3	23	4	21	2	15	2	11	5	38	3	16	1	8	1	5	2	15
Access improvements to the Newton Creek industrial area	1	6	3	23	1	6	3	23	6	38	3	23	6	38	0	0	2	13	4	31
Bypass around Philomath	8	47	6	46	0	0	1	8	2	12	1	8	1	6	2	15	6	35	3	23
Improved/new bicycle facilities	3	16	5	33	3	16	3	20	6	32	2	13	5	26	3	20	2	11	2	13
Design standards for residential streets	2	13	4	27	6	38	0	0	5	31	4	27	1	6	1	7	2	13	6	40
Parking	4	20	3	20	4	20	4	27	6	30	5	33	1	5	0	0	5	25	3	20

**TABLE C-2
COMMENTS REGARDING POTENTIAL ISSUES
TO BE ADDRESSED IN THE TSP**

Specific responses to the list of issues for both groups of respondents are shown below. Responses are preceded by the number of comments or mentions.

Number of comments, or mentions	Comment
3	◆ Consider cost.
3	◆ Open Applegate Street as a through street. If necessary put in speed bumps.
2	◆ Keep the heavy traffic away from the schools.
2	◆ Do not open Applegate Street. Concern regarding speed in front of high school, grade school, city library and parks. This might be nice for the unwanted development, but will not be an improvement for the safety of our children.
1	◆ Don't destroy Philomath's potential charm to provide a freeway to the coast.
1	◆ Beautification of downtown Philomath.
1	◆ Our businesses are being hurt by traffic congestion. Save downtown for customers, not for non-stop highway users.
1	◆ Bikers, walkers, children should have safe access to downtown shopping here in Philomath. The post office, clinic, vet offices, etc., should be accessible.
1	◆ Planning for added traffic, due to growth and other factors, in the area.
1	◆ Securing the future for our downtown area through good planning. Adopting a transportation plan that works hand-in-hand with the Beautification Action Team's suggestions on street improvements.
1	◆ Make bus system available to/from Philomath/Corvallis.
1	◆ Main Street/ Highway already separates us – Only a bypass would prevent some separations.
1	◆ Save Philomath from bisection by Highway 20/34.
1	◆ A route for trucks only to bypass Philomath.
1	◆ No truck traffic on North 13 th Street.
1	◆ Slow down traffic entering and leaving town.
1	◆ More speed bumps. Something needs to be done about traffic coming north off Bellfountain Road and not slowing or stopping at stop sign and shooting straight through the intersection and up Mt. Union at 35-50 mph.
1	◆ Don't build a couplet, bypass or otherwise change Philomath streets. Changes to accommodate future growth will only encourage such growth. Leave things as they are.
1	◆ I think that the couplet is the only way to go. Widening Main Street would severely damage my property on the southeast corner of 7 th and Main streets.
1	◆ City should build and pay for sidewalks along all city center neighborhoods.

**TABLE C-3
SITE-SPECIFIC IMPROVEMENTS AND NEEDS
OPEN HOUSE AND QUESTIONNAIRE RESPONSES¹**

Number of comments, or mentions	Comment
12	◆ Connect Applegate Street with a Newton Creek Bridge.
5	◆ Concerned about truck and car traffic getting onto Highway 20/34 from Clemens Mill Road (Pacific Softwoods) and Philomath Forest Products (across from Loggers' Supply).
4	◆ Study the possibility of a through truck route using Chapel Drive. (Let's get the big trucks out of town as there is no place for them to stop. This would benefit everyone.)
4	◆ Improve 19 th and Main Street intersection for truck turning.
4	◆ Bypass Highway 20: - Coast to I-5 traffic around Philomath. (2) - South side bypass roughly from 53 rd Street, along Chapel Drive and joining Highway 20 near milepost 49. (2)
3	◆ Pedestrian crosswalks with signal activation.
2	◆ Oppose opening up Applegate Street by building a bridge over Newton Creek. But if it has to be done, the through traffic needs to be kept off it. And the local traffic has to be forced to slow down. Stop signs at several, (not just the Creek), and speed bumps might help. Many kids walk to school that way.
1	◆ Newton Street connection east of 26 th street.
1	◆ 26 th Street light.
1	◆ Access onto Highway 20/34 across from 24 th Street.
1	◆ More traffic lights at 14, 15, and 16 th streets.
1	◆ Get rid of the ruts in the street on 13 th and Main Street.
1	◆ Concern regarding handling additional traffic on 13th street with railroad closures.
1	◆ Future extension of North 12 th Street.
1	◆ North 9 th Street alignment.
1	◆ Connect West Hills Road or Chapel Drive down to Highway 20 (less disturbance to homes).
1	◆ If the city wants sidewalks use taxes to pay for them. Long time residents have gotten along fine for all these years without this waste of money.
1	◆ Lights on Main Street to collector streets.
1	◆ A five lane Main Street.
1	◆ Parking for downtown shops on Main Street.
1	◆ Underground electrical source on Main Street.
1	◆ Paving all Philomath roads.
1	◆ Have several permanent blinking yellow lights for through traffic on Highway 20/34 through town at clearly market pedestrian crosswalks. Slow traffic down and enable pedestrians to cross.

¹ Comments on the proposed couplet are listed below with other couplet comments to decrease repetition. The number of comments, or mentions, precedes participants' statements where applicable.

Number of comments, or mentions	Comment
1	◆ On West Hills Rd., cars bypassing Philomath treat this section like a speedway -- up to 60 mph. Danger to people and animals.
1	◆ Let us try to have a block or two downtown on Main Street that has reduced (or no) traffic and little coffee shops or restaurants, local businesses not McDonald's type, and if permission can be obtained, let them put tables out on the sidewalk in the summer, like 2 nd Street in Corvallis. Let the through drivers glimpse this, and see signs to direct them to parking facilities. Also, connect it to the bicycle paths. Corvallis people can then spend time (and money) in Philomath.

APPENDIX D
1997 MAJOR STREET INVENTORY

1997 Major Streets Inventory
Philomath Transportation System Plan

Street	Jurisdiction	Classification ⁴	Speed Limit (mph)	ROW Width (feet)	Street Width (feet)	No. of Travel Lanes	Direction of Travel	On-Street Parking	Shoulders			1997 Pavement			Curb cuts at intersections	Comments			
									Width (feet)	Side	Paving	Condition ³	sidewalks	Curbs					
ARTERIALS																			
Main Street (US Highway 20/OR 34)																			
West city limits to 100' W. of 7th Street	State	Major Arterial	35	60	48	3	Two-way	No	No	NA	NA	Shared Roadway ²	No	Yes	Poor	No	No	NA	
100' W. of 7th Street to 7th Street	State	Major Arterial	35	60	48	3	Two-way	Eastbound	No	NA	NA	Shared Roadway ²	No	Yes	Poor	No	Both Sides	Intermittent	
7th Street to 100' W. of 8th Street	State	Major Arterial	35	80	48	3	Two-way	Eastbound	No	NA	NA	Shared Roadway ²	No	Yes	Poor	Eastbound	Both Sides	Intermittent	Sidewalks setback 4-6'
100' W. of 8th Street to 8th Street	State	Major Arterial	35	80	48	3	Two-way	Eastbound	No	NA	NA	Shared Roadway ²	No	Yes	Poor	Westbound	Both Sides	Intermittent	Sidewalks setback 4-6'
8th Street to 9th Street	State	Major Arterial	35	80	48	3	Two-way	No	No	NA	NA	Shared Roadway ²	No	Yes	Poor	Westbound	Westbound	Intermittent	Sidewalks setback 4-6'
9th Street to 10th Street	State	Major Arterial	35	80	48	3	Two-way	Eastbound	No	NA	NA	Shared Roadway ²	No	Yes	Poor	Both Sides	Both Sides	Intermittent	Sidewalks setback 4-6'
10th Street to 11th Street	State	Major Arterial	35	80	48	3	Two-way	Eastbound	No	NA	NA	Shared Roadway ²	No	Yes	Poor	Both Sides	Both Sides	Intermittent	Sidewalks setback 4-6'
11th Street to 150' W. of 12th Street	State	Major Arterial	35	80	48	3	Two-way	Both Sides	No	NA	NA	Shared Roadway ²	No	Yes	Poor	Both Sides	Both Sides	No	Sidewalks setback 4-6'
150' W. of 12th Street to 12th Street	State	Major Arterial	25	80	48	3	Two-way	Both Sides	No	NA	NA	Shared Roadway	No	Yes	Poor	Both Sides	Both Sides	No	Sidewalks setback 4-6'
12th Street to 13th Street	State	Major Arterial	25	80	48	3	Two-way	Both Sides	No	NA	NA	Shared Roadway	No	Yes	Poor	Both Sides	Both Sides	Intermittent	Sidewalks setback 4-6'
13th Street to 14th Street	State	Major Arterial	25	80	48	3	Two-way	Both Sides	No	NA	NA	Shared Roadway	No	Yes	Poor	Both Sides	Both Sides	Intermittent	Sidewalks setback 4-6'
14th Street to 16th Street	State	Major Arterial	25	80	48	3	Two-way	Westbound	No	NA	NA	Shared Roadway	No	Yes	Poor	Both Sides	Both Sides	Intermittent	Sidewalks setback 4-6'
16th Street to 150' E. of 16th Street	State	Major Arterial	25	80	48	3	Two-way	Westbound	No	NA	NA	Shared Roadway	No	Yes	Poor	Both Sides	Both Sides	Intermittent	Sidewalks setback 4-6'
150' E. of 16th Street to 19th Street	State	Major Arterial	25	80	48	3	Two-way	No	No	NA	NA	Shared Roadway	No	Yes	Poor	Both Sides	Both Sides	Intermittent	Sidewalks setback 4-6'
19th Street to Newton Creek Bridge	State	Major Arterial	35	80	24	2	Two-way	No	4 - 6	Both Sides	Paved	Shoulder Bikeway	No	Yes	Poor	No	No	NA	
Newton Creek Bridge to East city limit	State	Major Arterial	40	80	24	2	Two-way	No	4 - 6	Both Sides	Paved	Shoulder Bikeway	No	Yes	Fair	No	No	NA	
Aalsea Highway (OR Highway 34)																			
Main Street (US Hwy 20) to Flynn Bridge	State	Minor Arterial	45	60	24	2	Two-way	No	4 - 6	Both Sides	Partial	Shoulder Bikeway	No	Yes	Fair	No	No	NA	
Flynn Bridge to Grange Hall Road	State	Minor Arterial	45	90	24	2	Two-way	No	4 - 6	Both Sides	Partial	Shoulder Bikeway	No	Yes	Fair	No	No	NA	
COLLECTORS																			
Nineteenth Street																			
City limits to College Street	City	Major Collector	25	60 - 70	47	3	Two-way	No	6	Both	Paved	Bike Lanes	Both Sides	Yes	Fair	Partial, West Side	Both Sides	All	6-foot shoulder bike lanes
College Street to Main Street	City	Major Collector	25	70	40	2	Two-way	Both Sides	No	NA	NA	Shared Roadway	No	Yes	Fair	West Side	Both Sides	All	Sidewalks setback 4-6'
Main Street to Cedar Street	County	Major Collector	25	60	22	2	Two-way	Both Sides	8	Both	Gravel	Shared Roadway	No	Yes	Fair	Both Sides	Both Sides	All	Curb sidewalks
Cedar Street to 200' south of Cedar	County	Major Collector	25	60	22	2	Two-way	No	2 - 4	West	Gravel	Shared Roadway	No	Yes	Fair	East Side	No	No	
200' south of Cedar to Chapel Road	County	Major Collector	25	60	30	2	Two-way	East Side	2 - 4	West	Gravel	Shared Roadway	No	Yes	Fair	East Side	East Side	All	
Green Road (Nineteenth Street)																			
West Hills Road to Industrial Way	County	Major Collector	45	60 - 75	35 - 45	2	Two-way	No	6	Both	Paved	Bike Lanes	Both Sides	Yes	Fair	No	Partial, West Side	All	6-foot shoulder bike lanes
Industrial Way to SP Railroad crossing	County	Major Collector	45	60	35	2	Two-way	No	6	Both	Paved	Bike Lanes	Both Sides	Yes	Fair	No	Partial, West Side	All	6-foot shoulder bike lanes
SP Railroad crossing to City limits	County	Major Collector	45	70	47	3	Two-way	No	6	Both	Paved	Bike Lanes	Both Sides	Yes	Fair	Partial, East Side	Both Sides	All	6-foot shoulder bike lanes
West Hills Road																			
City Limits to Quail Glen Drive	County	Major Collector	25	40 - 50	20	2	Two-way	No	No	NA	NA	Shared Roadway	No	4-ton limit	Fair	No	No	NA	
Quail Glen Drive to Wyatt Lane	County	Major Collector	45	40 - 50	20	2	Two-way	No	No	NA	NA	Shared Roadway ²	No	4-ton limit	Fair	No	No	NA	
Wyatt Lane to N. 19th Avenue	County	Major Collector	45	60	20	2	Two-way	No	No	NA	NA	Shared Roadway ²	No	4-ton limit	Fair	No	No	NA	Ditch on both sides of road
N. 19th Avenue to Reservoir Avenue (UGB)	County	Major Collector	45	60	34	2	Two-way	No	No	NA	NA	Bike Lanes	Both Sides	Yes	Fair	No	No	NA	6-foot shoulder bike lanes
Reservoir Avenue to Eastbound	County	Major Collector	45	60	20	2	Two-way	No	2 - 4	Both Sides	Gravel	Shared Roadway ²	No	Yes	Fair	No	No	NA	
Ninth Street																			
City Limits to 200' north of Pioneer Street	City	Major Collector	25	40	20	2	Two-way	No	No	NA	NA	Shared Roadway	No	4-ton limit	Fair	No	No	NA	
200' north of Pioneer Street to Main Street	City	Major Collector	25	80	40	2	Two-way	Both Sides	No	NA	NA	Shared Roadway	No	4-ton limit	Good	Partial, Both Sides	Both Sides	No	
Thirteenth Street																			
Chapel Road to 500' south of Applegate Street	County	Major Collector	45	60	19	2	Two-way	No	2 - 4	Both Sides	Gravel	Shared Roadway ²	No	12-ton limit	Fair	No	No	NA	
500' south of Applegate Street to Applegate Street	County	Major Collector	25	60	19	2	Two-way	No	2 - 4	Both Sides	Gravel	Shared Roadway	No	12-ton limit	Fair	No	No	NA	
Applegate Street to Main Street	County	Major Collector	25	80	50	2	Two-way	Both Sides	No	NA	NA	Shared Roadway	No	12-ton limit	Good	Both Sides	Both Sides	All	West sidewalk 10' setback

**1997 Major Streets Inventory
Philomath Transportation System Plan**

Street	Jurisdiction	Classification ⁴	Speed Limit (mph)	ROW Width (feet)	Street Width (feet)	No. of Travel Lanes	Direction of Travel	On-Street Parking	Shoulders			Bikeway ¹	Bike Lanes	Truck Route	1997 Pavement Condition ³	sidewalks	Curbs	Curb cuts at intersections	Comments
									Width (feet)	Side	Paving								
BellFountain Road																			
Chapel Road to Plymouth Drive	County	Major Collector	45	60	30	2	Two-way	No	4	Both Sides	Paved	Shoulder Bikeway	No	Yes	Very Good	No	No	NA	
Mt. Union Avenue																			
Chapel Road to Plymouth Drive	City	Major Collector	25	60	28	2	Two-way	West Side	No	NA	NA	Shared Roadway	No	Yes	Poor	West Side	West Side	NA	
Chapel Road																			
Fern Road to 500' west of 13th Street	County	Major Collector	40	60	22	2	Two-way	West Side	No	NA	NA	Shared Roadway ²	No	Yes	Fair	No	No	NA	Ditch on both sides of road
500' west of 13th Street to 13th Street	County	Major Collector	40	60	22	2	Two-way	West Side	No	NA	NA	Shared Roadway ²	No	Yes	Fair	No	No	NA	Ditch on both sides of road
13th Street to 19th Street	County	Major Collector	40	60	22	2	Two-way	West Side	6 - 8	South Side	Gravel	Shared Roadway ²	No	Yes	Fair	No	No	NA	Ditch on north side of road
19th Street to Middle School Access	County	Major Collector	40	60	22	2	Two-way	West Side	4 - 6	North Side	Paved	Shoulder Bikeway	No	Yes	Good	North side	North Side	No	
Middle School Access to 500' east of School	County	Major Collector	40	60	22	2	Two-way	West Side	2 - 4	Both Sides	Partial	Shared Roadway ²	No	Yes	Good	No	No	NA	
500' east of Middle School to BellFountain Road	County	Major Collector	55	60	22	2	Two-way	West Side	2 - 4	Both Sides	Partial	Shared Roadway ²	No	Yes	Good	No	No	NA	
OTHER ROADWAYS																			
Applegate Street																			
West end to 9th Street	City	Not classified	25	60	42	2	Two-way	Both Sides	No	NA	NA	Shared Roadway	No	Yes	Good	North, Partial South	Both Sides	All	
9th Street to 12th Street	City	Not classified	25	60	42	2	Two-way	Both Sides	No	NA	NA	Shared Roadway	No	4-ton limit	Fair	Both Sides	Both Sides	All	
12th Street 13th Street	City	Not classified	25	60	42	2	Two-way	Both Sides	No	NA	NA	Shared Roadway	No	4-ton limit	Fair	South, Partial North	Both Sides	All	
13th Street to 23rd Street	City	Not classified	25	60	42	2	Two-way	Both Sides	No	NA	NA	Shared Roadway	No	4-ton limit	Fair	Both Sides	Both Sides	All	
College Street																			
20th Street to 19th Street	City	Not classified	25	80	20	2	Two-way	Both Sides	6 - 8	Both Sides	Gravel	Shared Roadway	No	4-ton limit	Poor	No	No	NA	
19th Street to 18th Street	City	Not classified	25	80	20	2	Two-way	Both Sides	6 - 8	Both Sides	Gravel	Shared Roadway	No	4-ton limit	Poor	No	No	NA	
18th Street to 17th Street	City	Not classified	25	80	20	2	Two-way	Both Sides	6 - 8	Both Sides	Gravel	Shared Roadway	No	4-ton limit	Poor	North Side	No	NA	4' Sidewalks setback 20'
17th Street to 12th Street	City	Not classified	25	80	20	2	Two-way	Both Sides	6 - 8	Both Sides	Gravel	Shared Roadway	No	4-ton limit	Poor	Both Sides	No	NA	4' Sidewalks setback 20'
Grange Hall Road																			
Alsea Highway to Greasy Creek Bridge	County	Not classified	45	40	19	2	Two-way	No	No	NA	NA	Shared Roadway ²	No	Yes	Poor	No	No	NA	Ditch on both sides of road
Greasy Creek Bridge to Fern Road	County	Not classified	45	40	19	2	Two-way	No	No	NA	NA	Shared Roadway ²	No	Restricted ⁵	Poor	No	No	NA	Ditch on both sides of road
Fern Road																			
Grange Hall Road to Chapel Road	County	Not classified	45	60	19	2	Two-way	No	2 - 4	Both Sides	Gravel	Shared Roadway ²	No	Yes	Good	No	No	NA	
LEGEND/NOTES																			
Note 1: The three bikeway design treatments for bicycle facilities on roadways outlined in the 1995 <i>Oregon Bicycle and Pedestrian Plan</i> : (1) shared roadway, (2) shoulder bikeway, and (3) bike lanes.																			
Note 2: These roadway segments function as a shared roadway facility. However, no design treatments have been applied to these facilities (e.g., striped bike lanes, etc.) in concert with the current Oregon Bicycle and Pedestrian Plan. Posted speeds above 25 mph are not recommended for shared roadway bikeway facilities.																			
Note 3: Pavement condition information for arterials is from the 1997 ODOT Pavement Condition Report. Condition information for collectors is based on field survey conducted by DEA in January 1998.																			
Note 4: Based on ODOT Street Classification.																			
Note 5: Posted truck weight restrictions as follows: 3-axle (24 tons), 5-axle (37 tons), and 6-axle (34 tons).																			

APPENDIX E
HOURLY LINK CAPACITIES USED IN TRAFFIC MODEL PLOTS

DESCRIPTION OF LEVEL OF SERVICE METHODOLOGY

SIGNAL WARRANT ANALYSIS

DETAILS OF OPERATIONS ANALYSIS AT INTERSECTIONS

HOURLY LINK CAPACITIES USED IN TRAFFIC MODEL PLOTS

AUTO VOLUMES

emme2

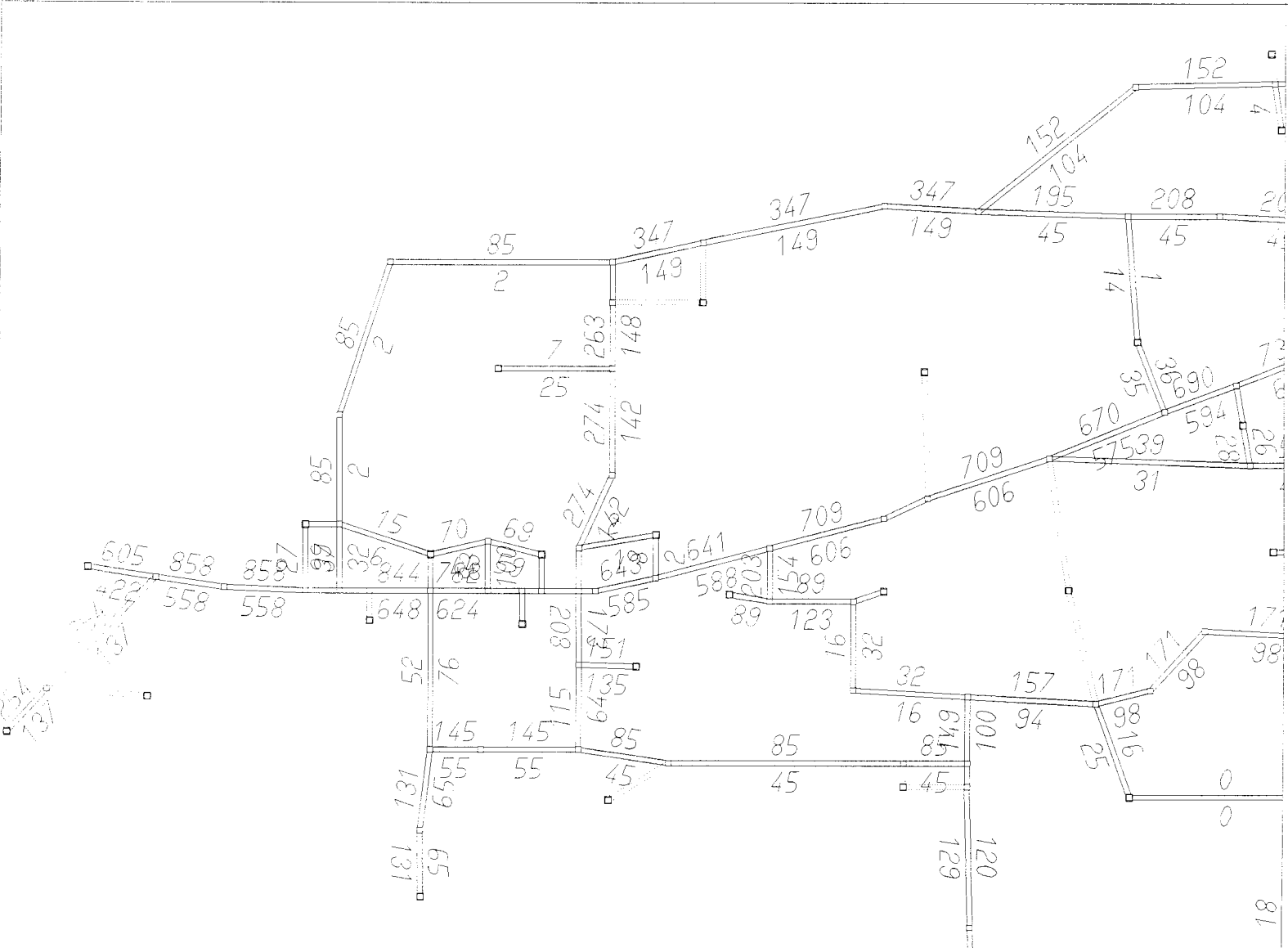

LINKS:
all

WINDOW A:
-218.17 360 94
152.087 648 06

AUTO VOLUMES

emme/2

LINKS
all

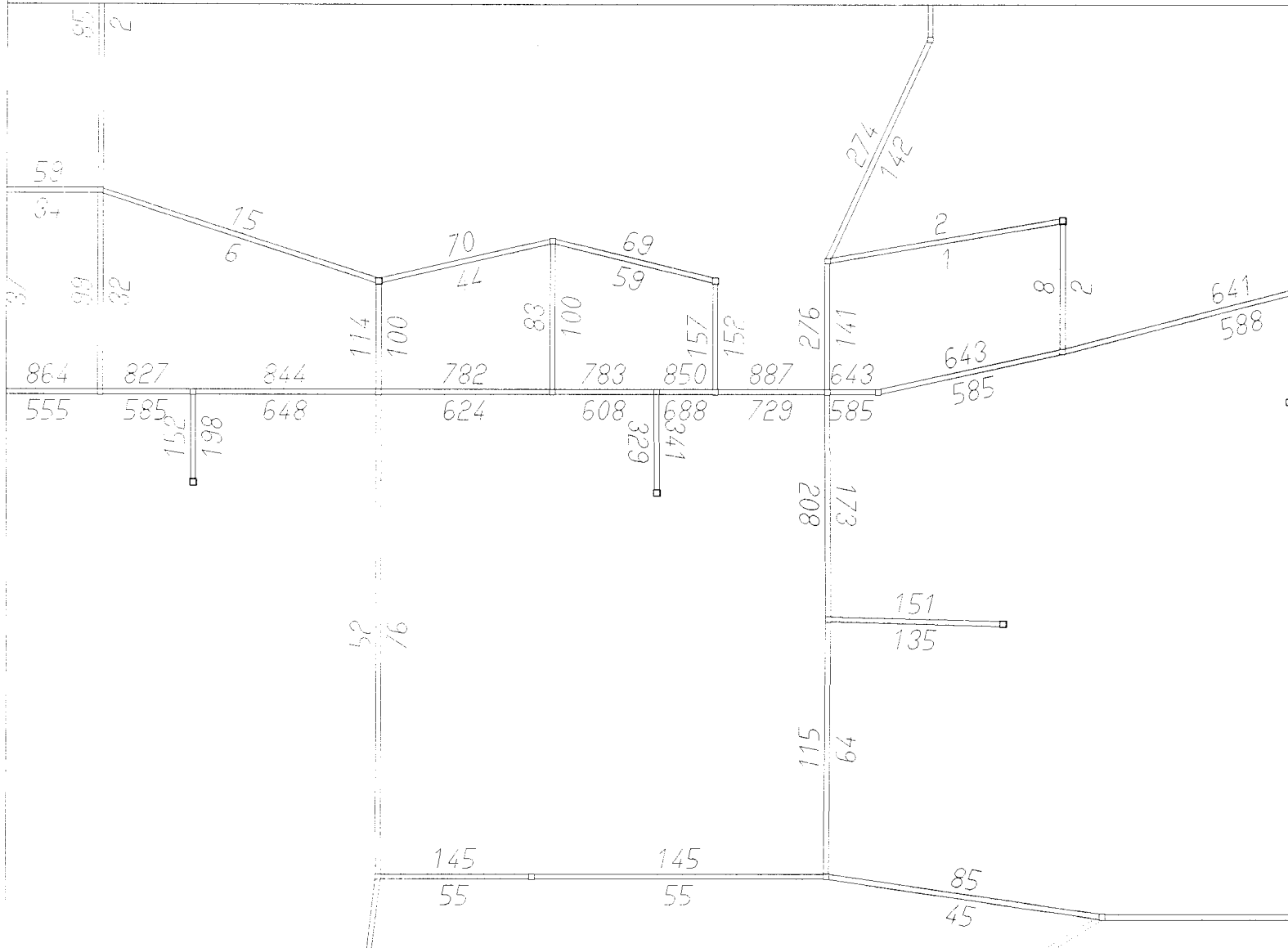

WINDOW B:
-127.17 413.52
-1.067 507.48

EMME/2 PROJECT: CORVALLIS EMME/2 MODEL CONVERSION W/ PHILOMATH ADDITION
SCENARIO: 11: 1991 PM PK HR - Modified BPR Curve

98-08-30 10:49
MODULE: 6 12
DRE

BASE NETWORK

ATTN: B. SVENIT VOLUME/CAPACITY RATIO

EJME

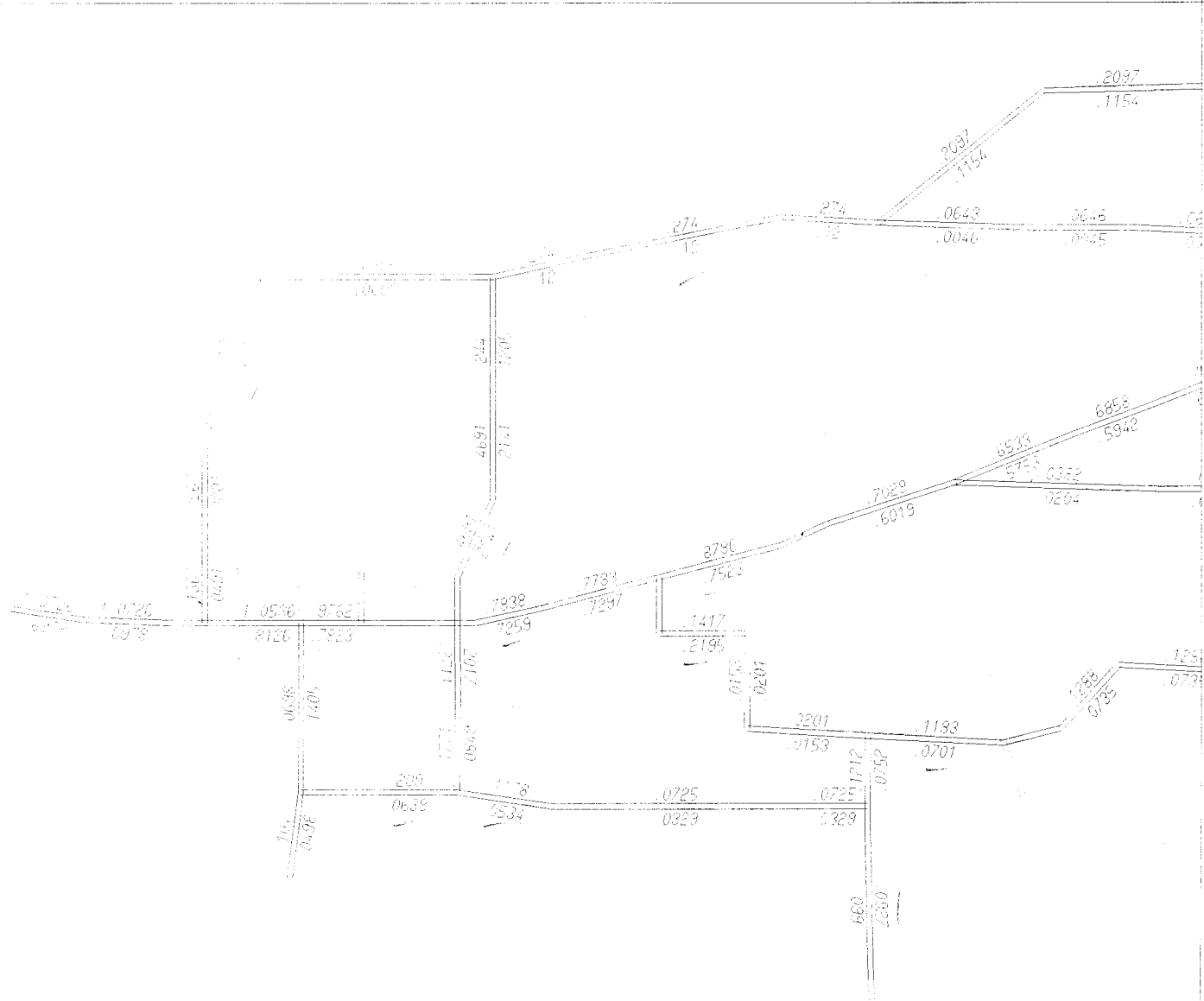

LINKS
 THRESHOLD
 UPPER 0.100

WINDOW A
 -248.17 366.94
 162.08/ 648.06

WORK SHEET FOR NETWORK LINK PROFILE CONVERSION W/ PHILMATH ADDITION
 DATE: 86-01-24 11:31
 BY: [illegible]

86-01-24 11:31
 162.08/ 648.06
 [illegible]

BASE NETWORK

ATTRIBS: @VC:RAT: VOLUME/CAPACITY RATIO

EMKE

DATE: 01/24/99
 USER: JPERE
 PROJECT: 8890

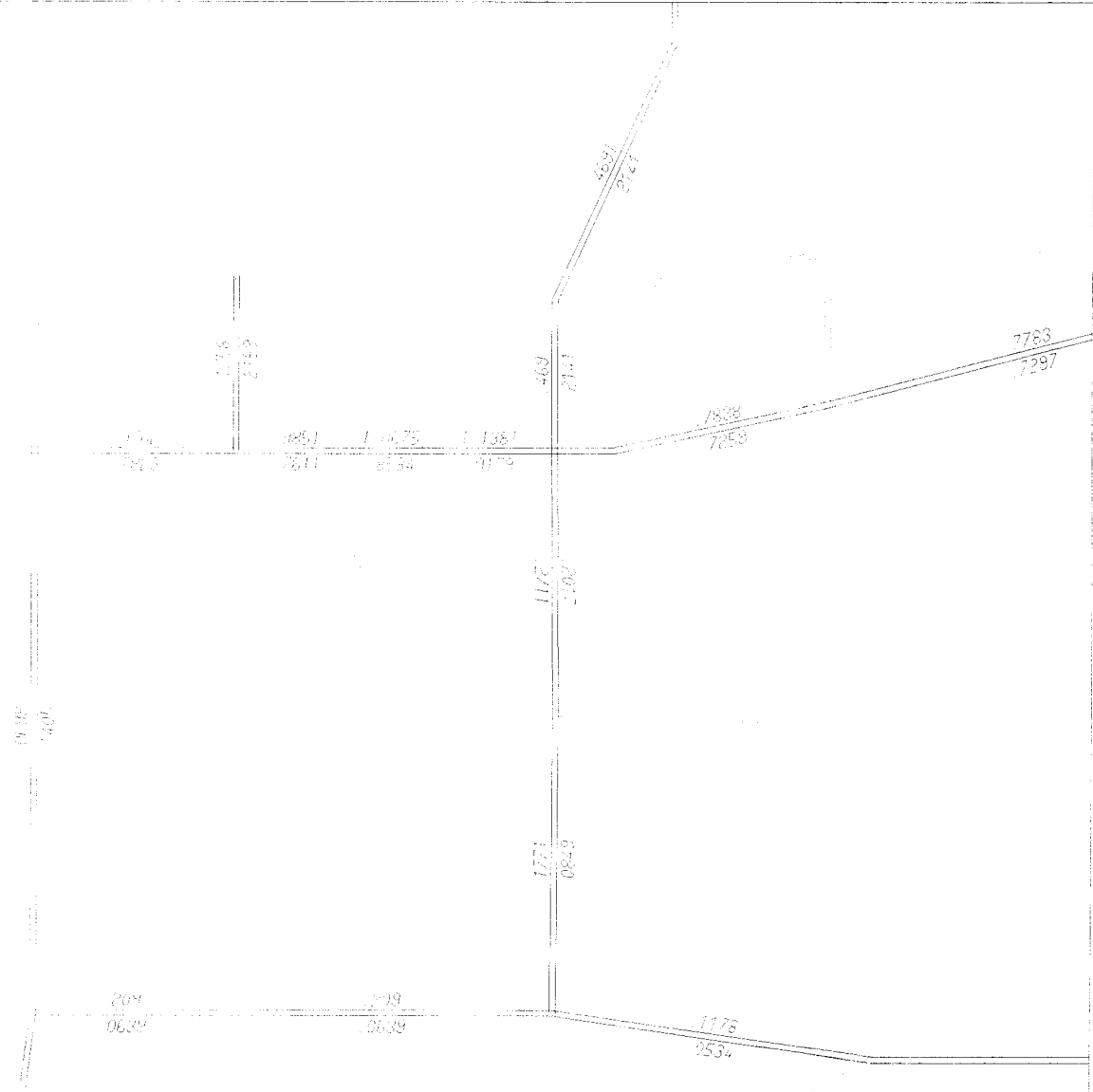

40100w @
 -127.17 413.52
 -1.867 507.48

89-01-24 11:32
 MODIFIED: 01/13
 DAE, 11/13/98

THIS DRAWING IS A PRELIMINARY MODEL CONVERSION WITH PRELIMINARY ADDITION
 OF NEW PIPE AND PUMPS TO EXISTING NETWORK. IT IS NOT TO BE USED FOR CONSTRUCTION.
 ALL DIMENSIONS ARE IN FEET UNLESS OTHERWISE NOTED.

AUTO VOLUMES

emme/2

LINKS
all

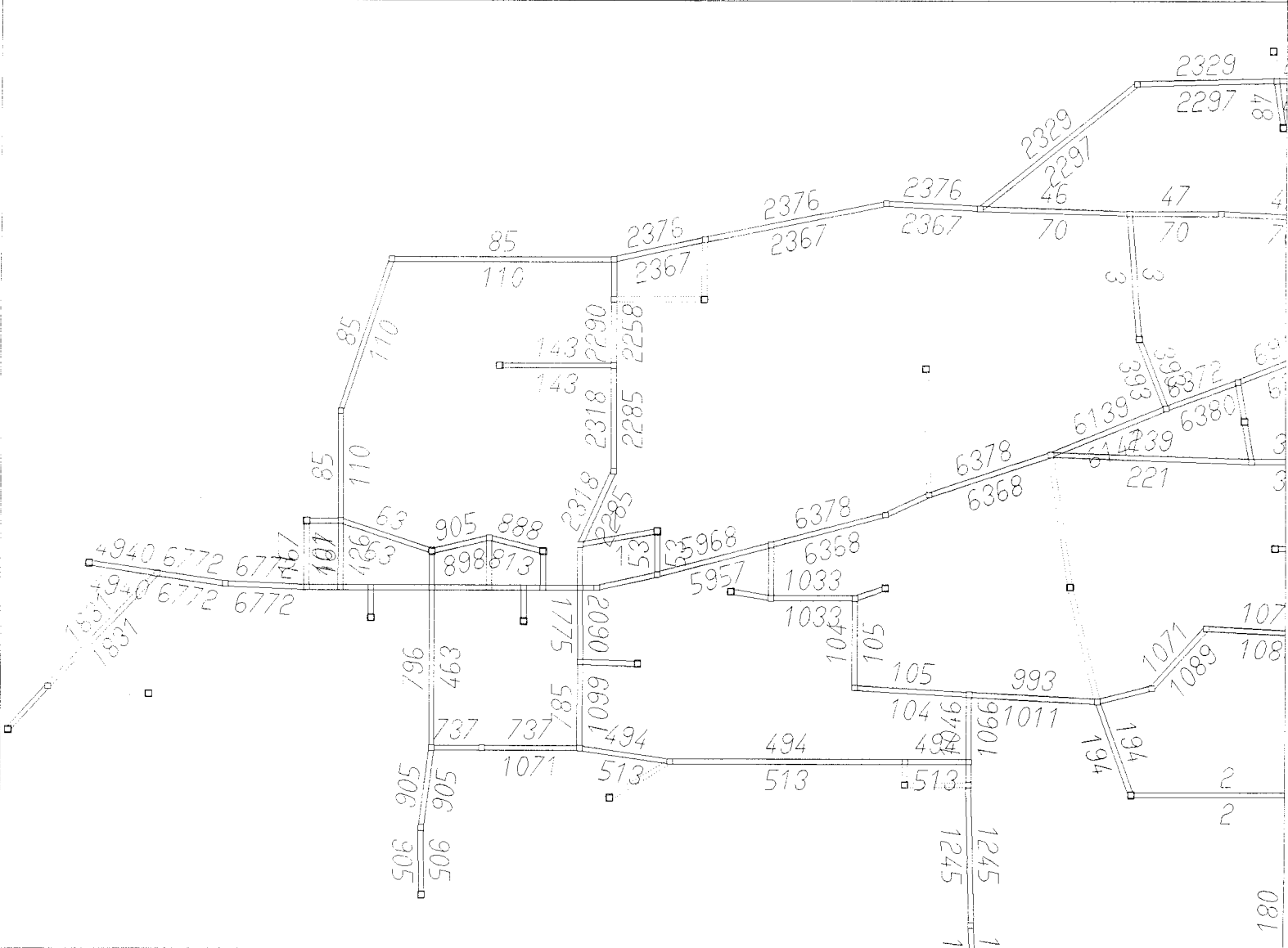

WINDOW A:
-218.17/ 360.94
162.08/ 646.06

EMME/2 PROJECT: CORVALLIS EMME/2 MODEL CONVERSION W/ PHILOMATH ADDITION
SCENARIO 2: 1991 Daily Model - Modified BPR Curve

98-06-30 13:49
MODULE: 6.12
DRE: bjd

AUTO VOLUMES

emme/2

LINKS
all

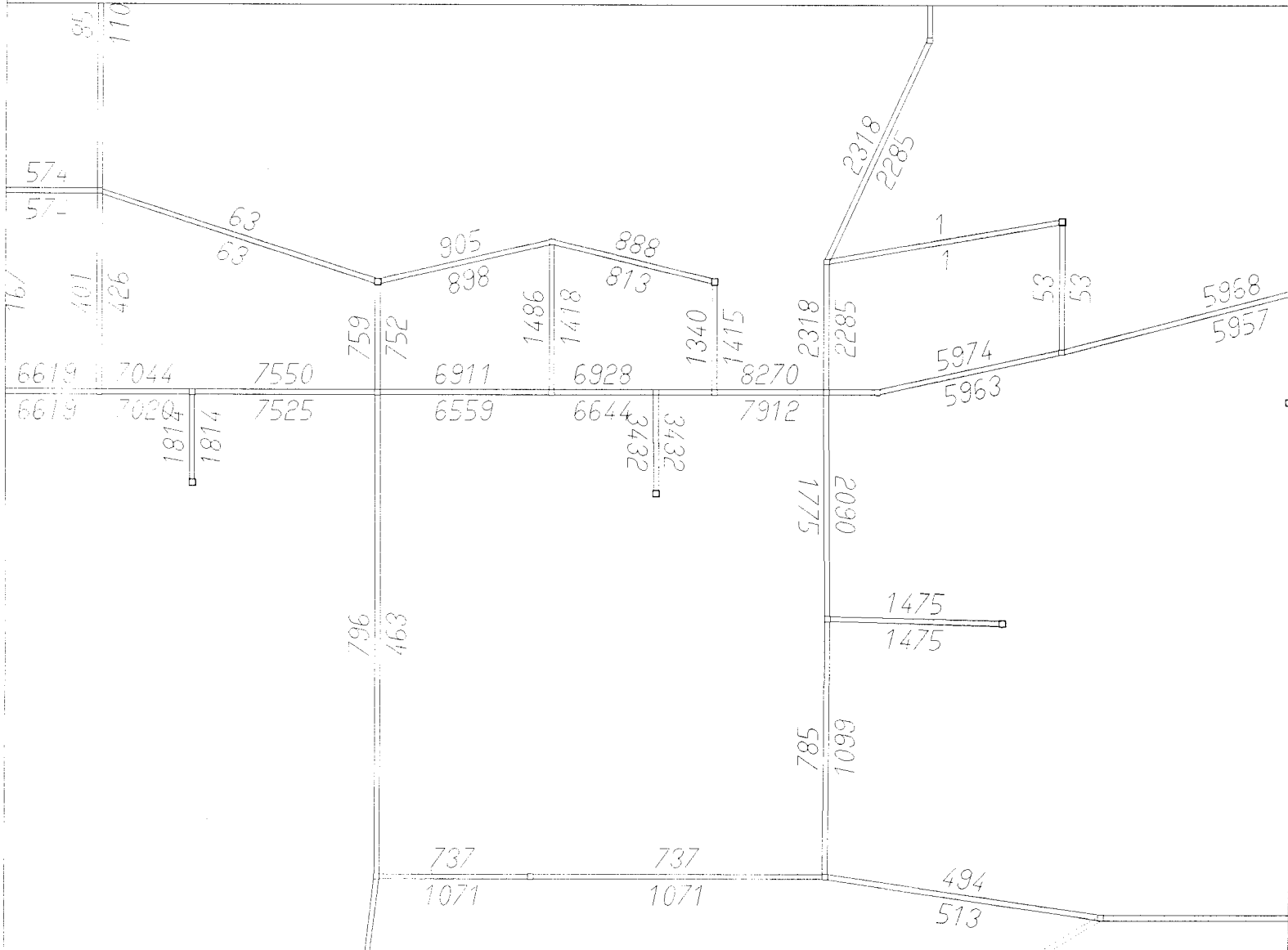

WINDOW 8
-127.17 413.52
-1.867 507.48

EMME/2 PROJECT: CORVALLIS EMME/2 MODEL CONVERSION W/ PHILOMATH ADDITION
SCENARIO: 2: 1991 Daily Model - Modified BPR Curve

98-06-30 13:49
MODULE: 6.12
DRAWN BY: bjd

AUTO VOLUMES

emme/2

LINKS:

all



WINDOW B
 -222.2/372.876
 -13.73/ 529.26

EMME/2 PROJECT: Corvallis-Philomath Study Area (62,500 population)
 SCENARIO 1: 2015- PM Peak Hour (No Build)

98-08-30 13 38
 MODULE: 6 12
 DAE: bjd

AUTO VOLUMES

emmet

LINKS

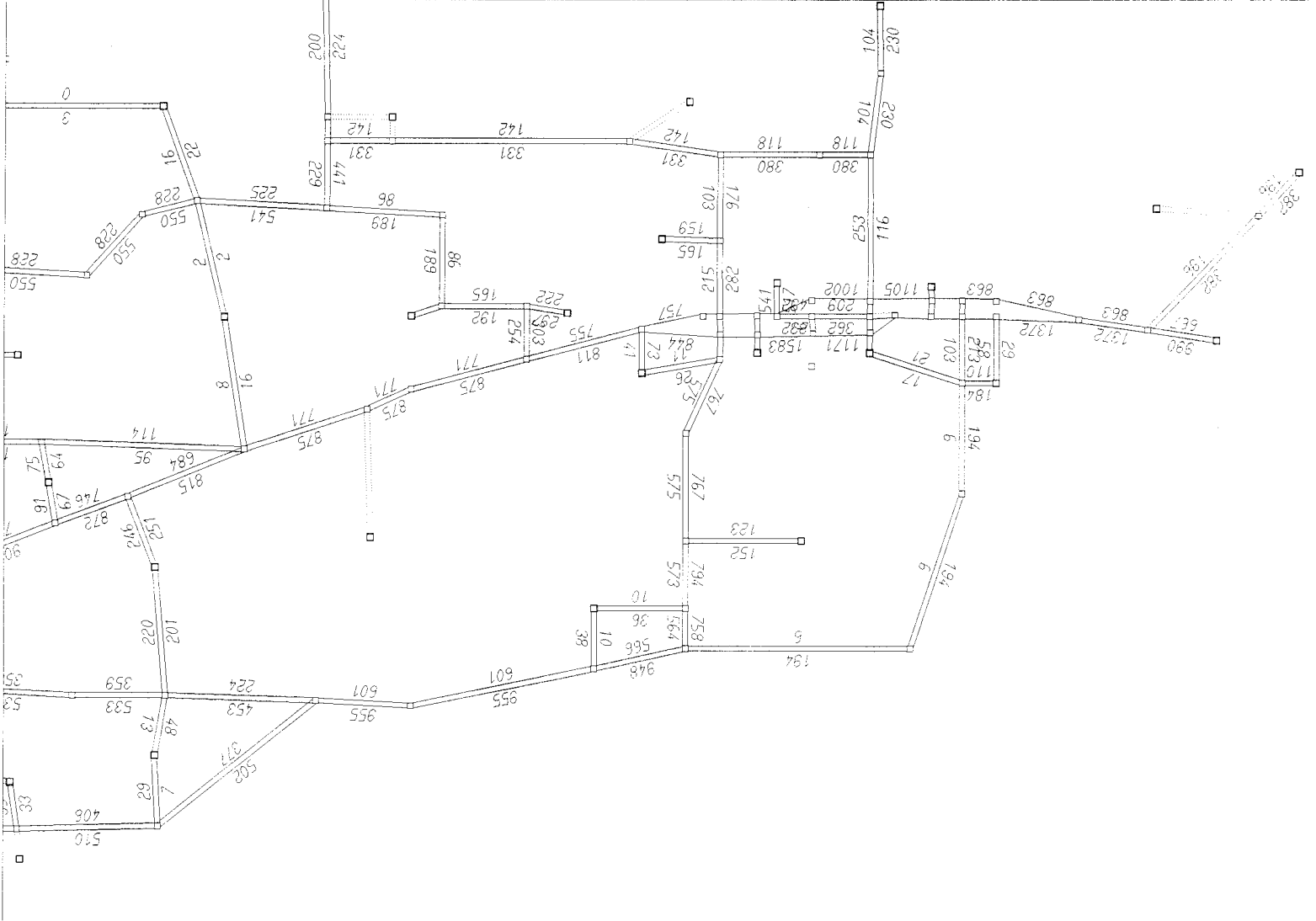

WINDOW #
-224/375 402
162.96/665.598

98-06-30 13:41
MOBILE: 8112
DRE: (b) (6)

EMMET PROJECT Corvallis-Philomath Study Area (62,500 population)
SCENARIO 40 2015 - One Way Couplet

ALTO VOLUMES



ALL LINKS

EMM&E

WINDOW 3
-228.2/372.876
-13.737/ 529.26

98-08-30 13.41
MODULE: 0.12
DRE: 0.12 BJD

AUTO VOLUMES

EMME2

LINKS

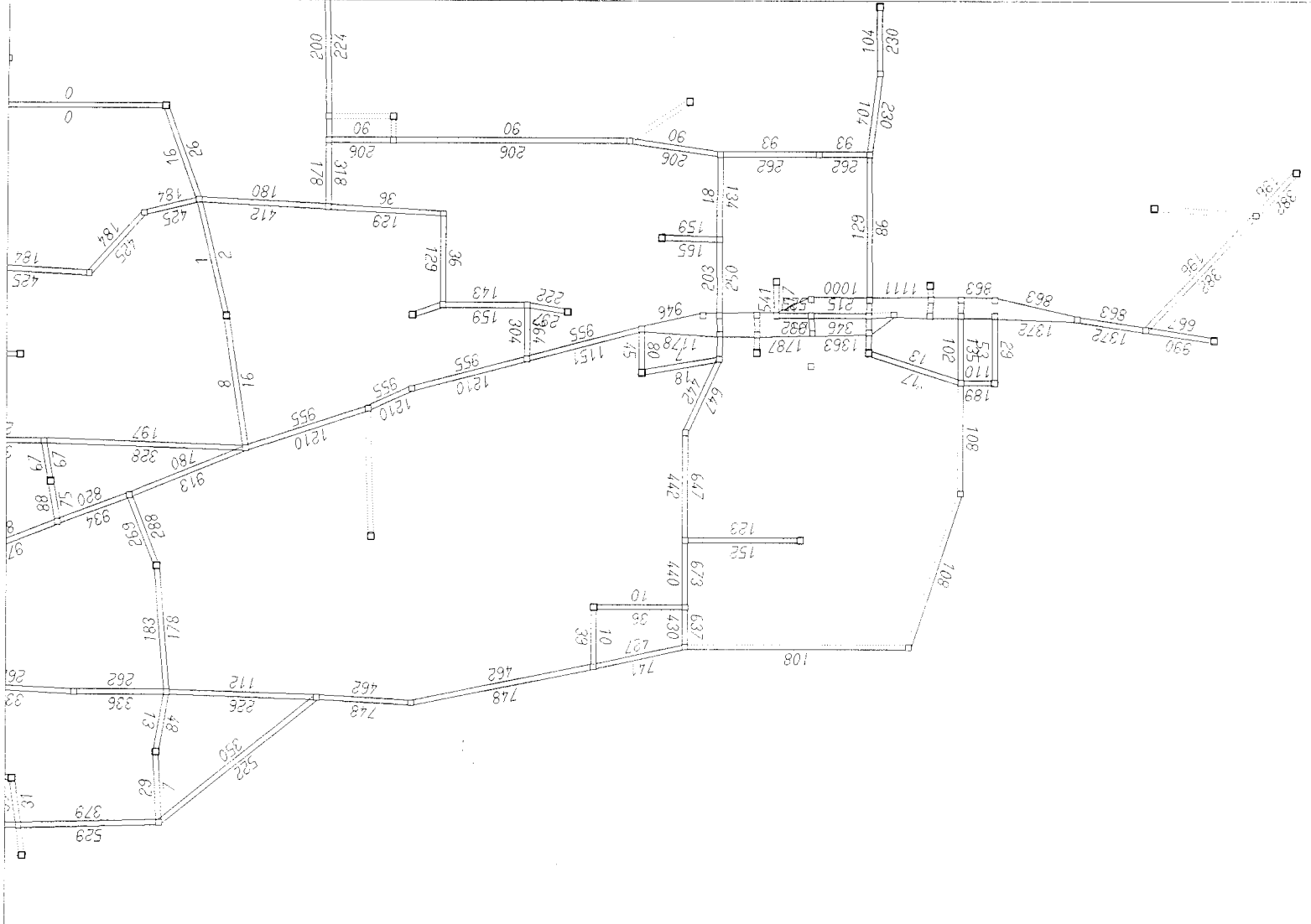

WINDOW R1
-224/375.402
162.96/665.598

98-06-30 13:43
MODULE: 8.12
DRAWING: 8.12

EMME2 PROJECT: Corvallis-Philomath Study Area (62,500 population)
SCENARIO: 411 2015- One Way Couplet W/Redd Cop. Imp.

AUTO VOLUMES

EMME2

LINKS

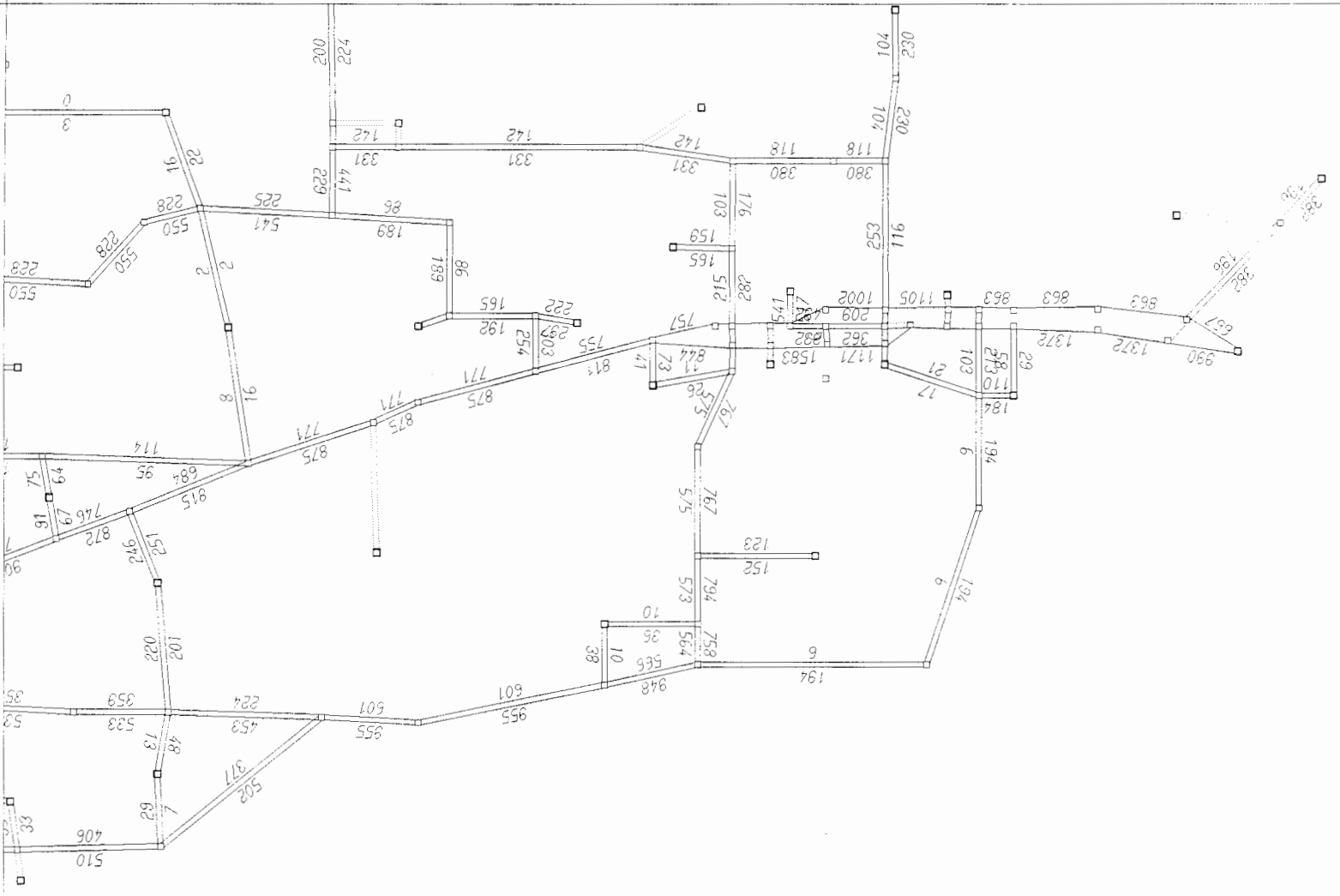

WINDOW #1
-224/373 402
162 96/665 598

98-06-30 13:44
MODULE: 612
DPE: RJD

EMME2 PROJECT: Corvallis-Philomath Study Area (62,500 population)
SCENARIO: 501 - 2015 - Extended One Way Couplet

EMME2

LINKS:

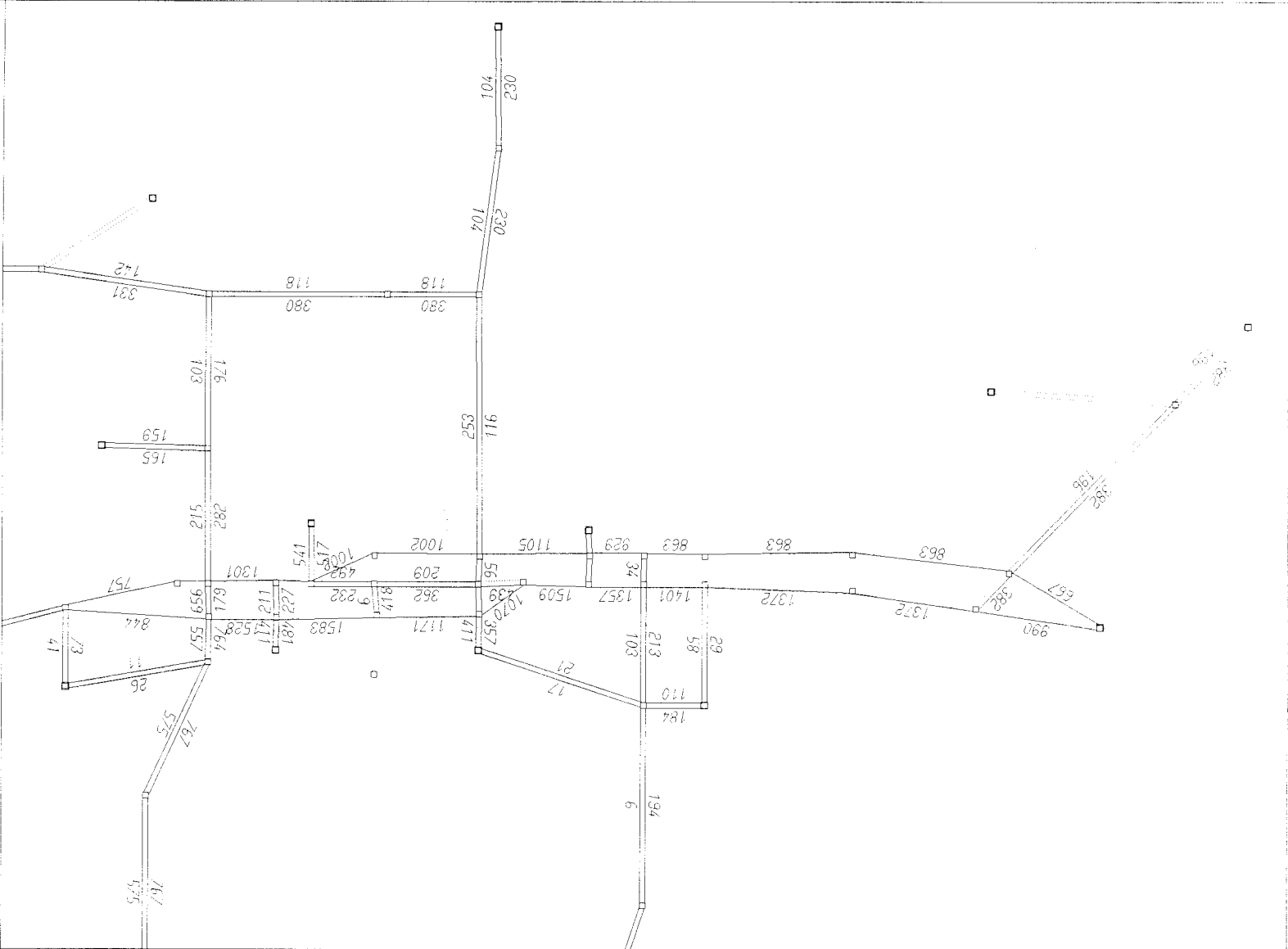

WINDOW 8:
-222,2/372,876
-13,73/ 529,28

98-06-30 13:44
MODULE: 012
DRE: 012

AUTO VOLUMES

EMME2 PROJECT: Corvallis-Philomath Study Area (62,500 population)
SCENARIO: 501 2015- Extended One Way Couplet

AUTO VOLUMES

EMME2

all LINKS

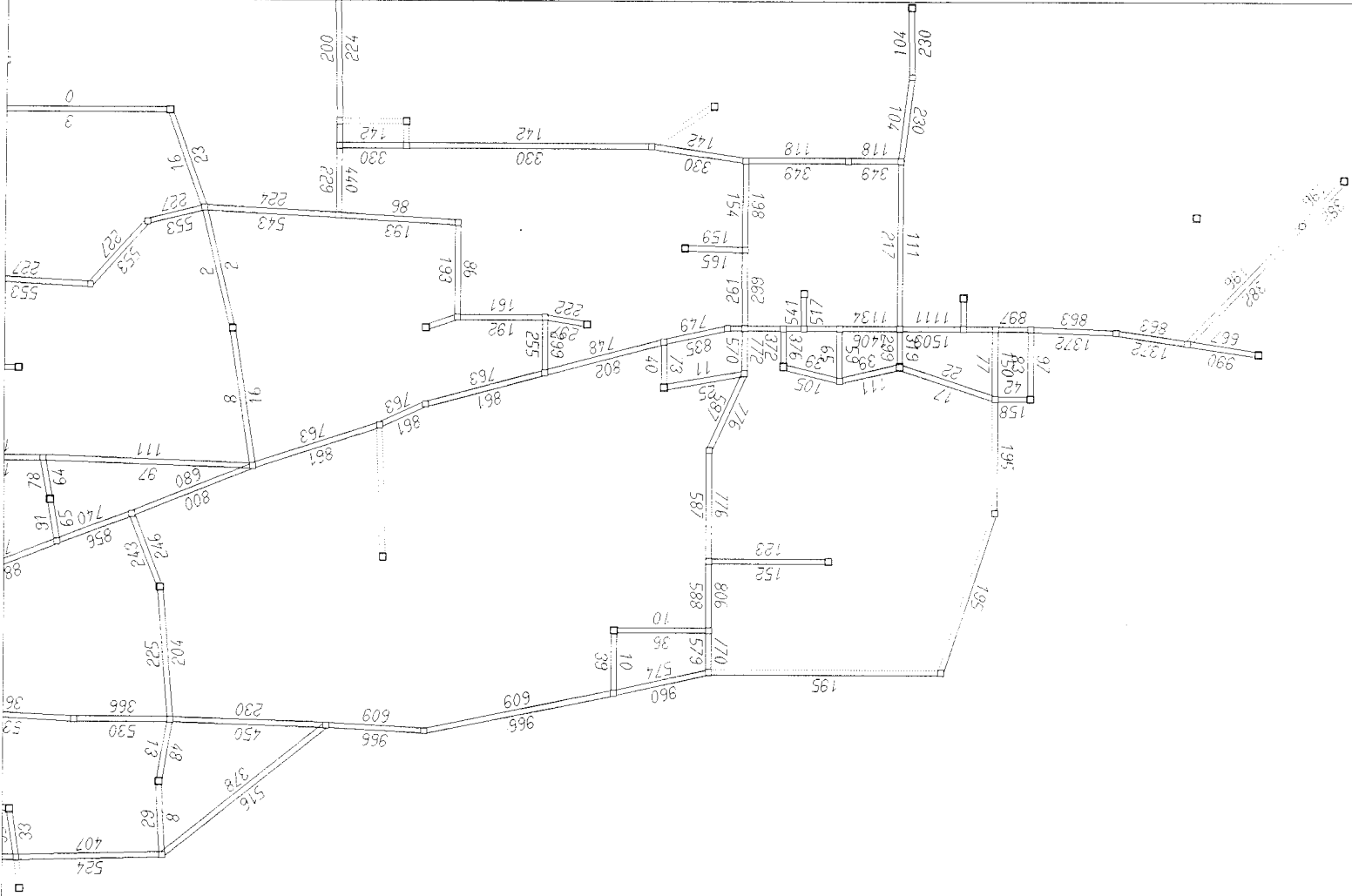

WINDOW #1
-224/375.402
162.86/665.598

98-06-30 13.44
MODULE: 6.12
DRE: PJR

EMME2 PROJECT: Corvallis-Philomath Study Area (62,500 population)
SCENARIO: 601: 2015- Widen Main St to 5 Lanes

AUTO VOLUMES

emme/2

LINKS

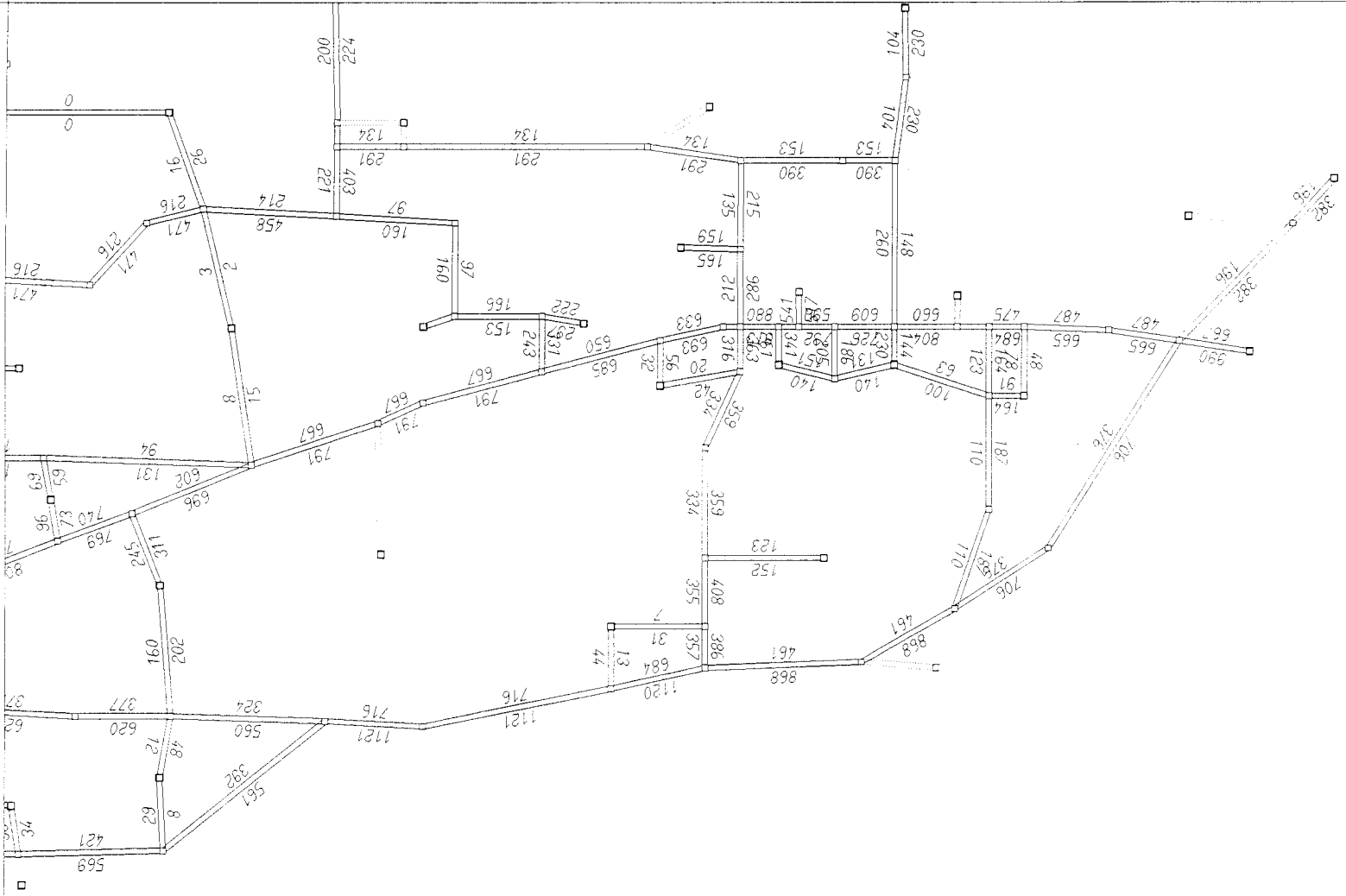

WINDOW #
-224/375.402
162.86/665.598

EMME/2 PROJECT: Corvallis-Philomath Study Area (62,500 population)
SCENARIO: 201: 2015- West Hills Rd. Extension
MODULE: 6.12
DATE: 98-05-16:41

RUTO VOLUMES



EMME2 PROJECT: Corvallis-Philomath Study Area (62,500 population)
SCENARIO: 2015- West Hills Rd. Extension

WINDOW B:
-222 2/372.876
-13 73/ 529.26

98-05-05 16:41
MODULE: 6 12
DRE: b10

LINKS

Emme2

AUTO VOLUMES

EMME2

LINKS

0.1

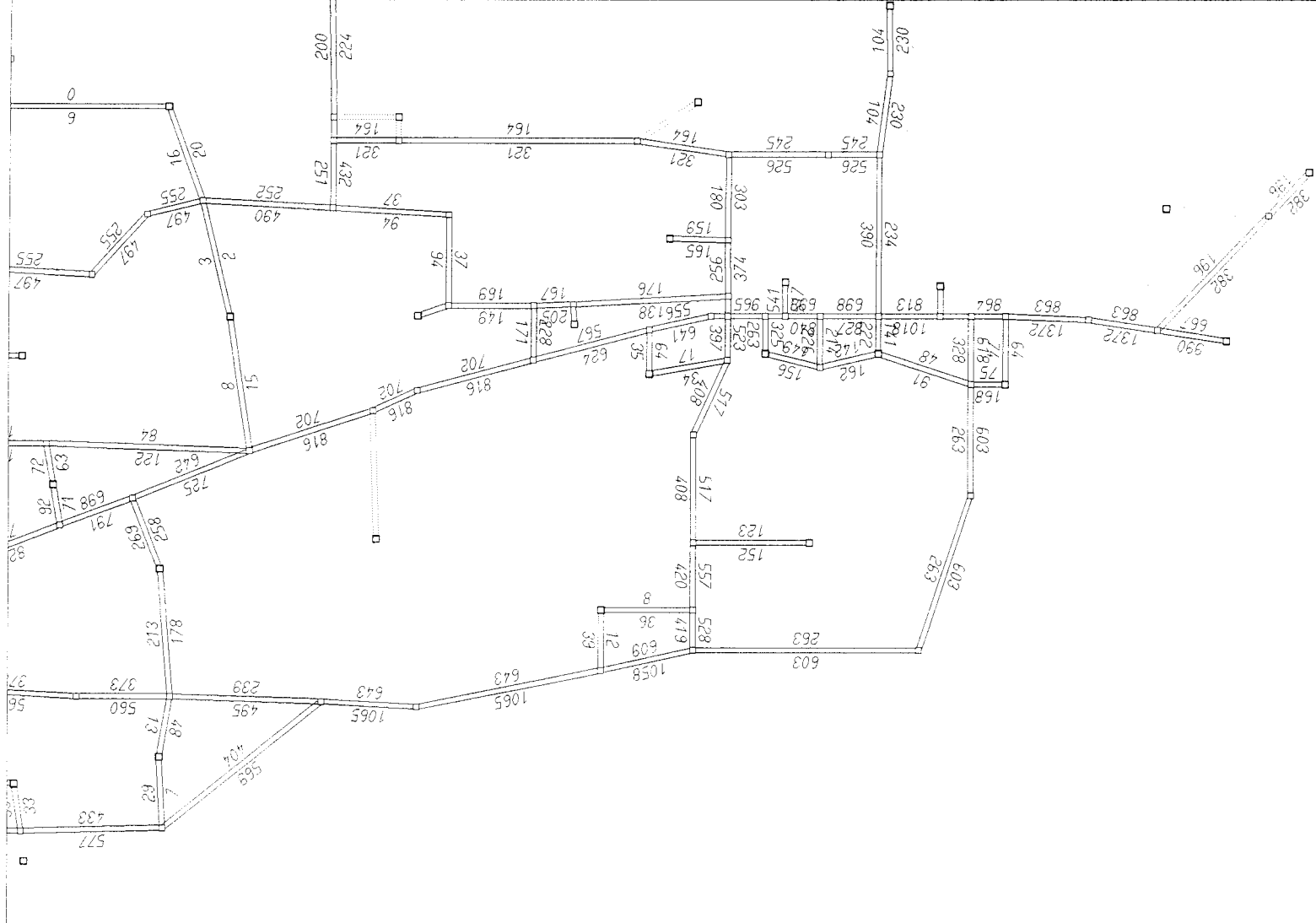

WINDOW 9:
-224/375.402
162 96/655.598

98-05-05 17 07
MODULE: 6 12
DRE: 10 10

EMME2 PROJECT: Corvallis-Philomath Study Area (62,500 population)
SCENARIO: 30: 2015- Applegate Connection Over Neuton Creek

AUTO VOLUMES

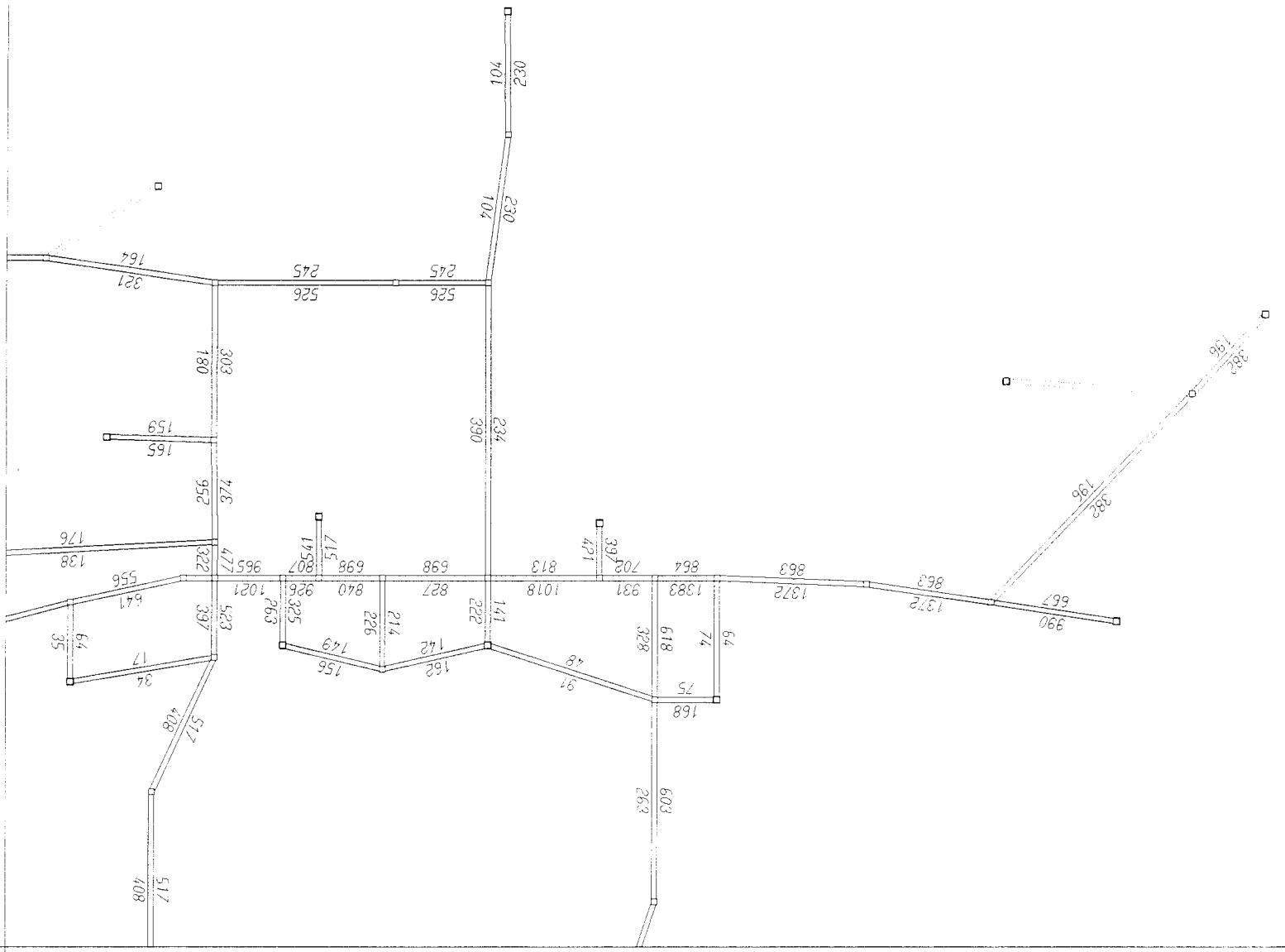

EMME2

LINES:

WINDOW B:
 -222 2/372 876
 -13 73/ 529 28
 98-05-05 17:07
 MODULE: 6 12
 DAE: PID

EMME2 PROJECT: Corvallis-Philomath Study Area (62,500 population)
 SCENARIO: 30: 2015- Applegate Connection Over Neuton Creek

Auto VOLUMES

EMME/2

LINKS

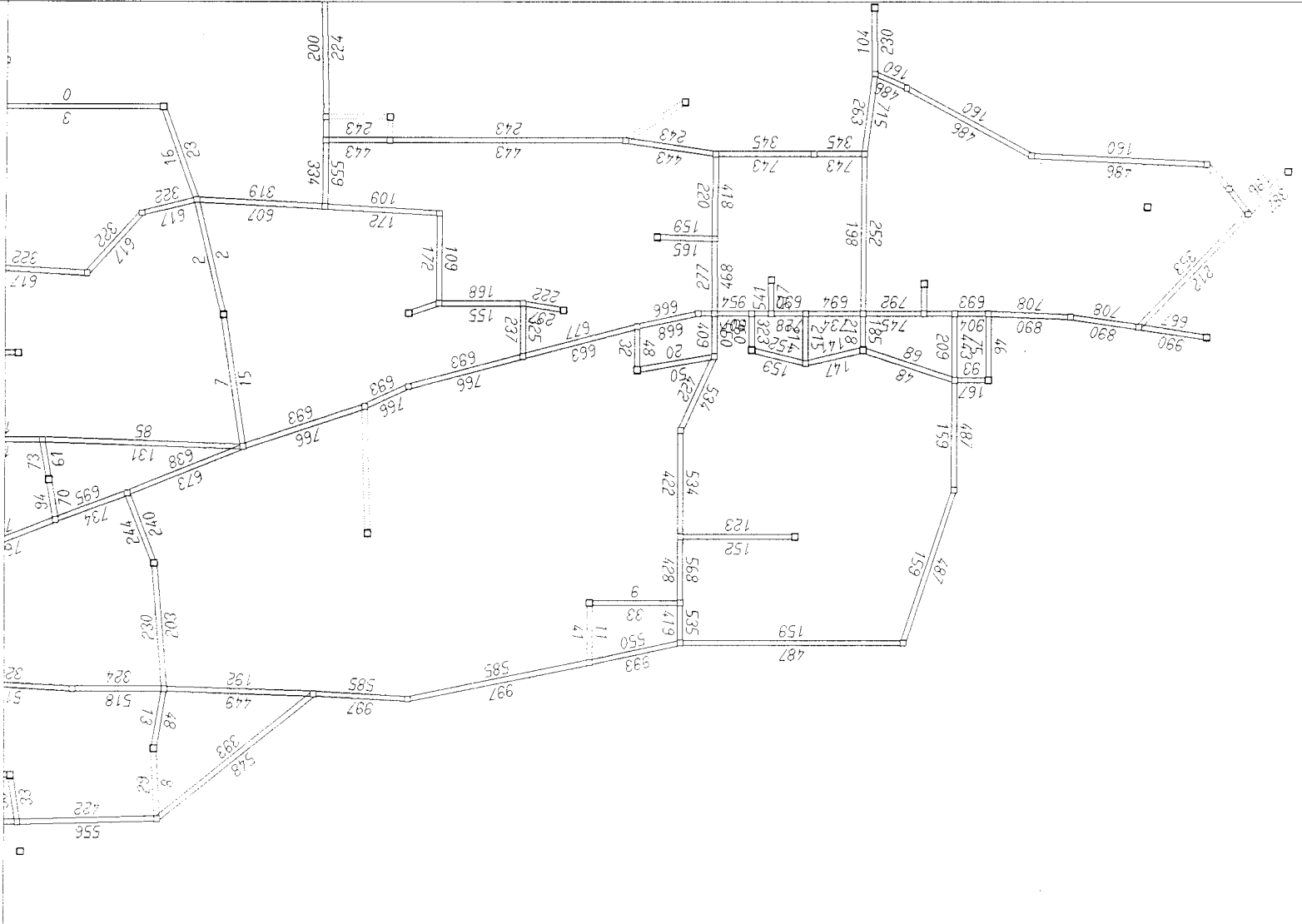

AUTO VOLUMES

EMME 2

LINCS:

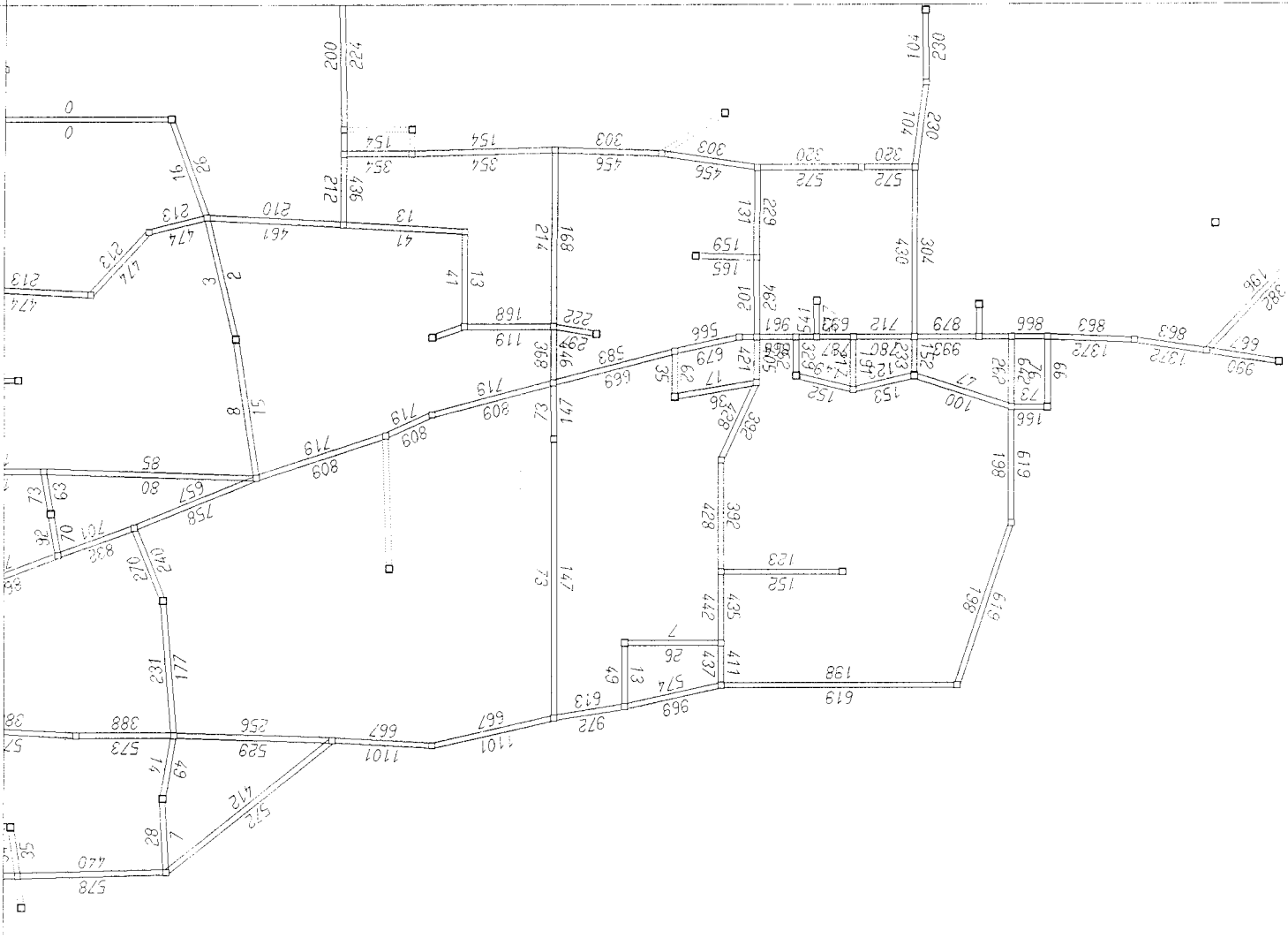

EMME 2 PROJECT Carrollts-Philomath Study Area (62,500 population)
 SCENARIO 80 2015-26th St. Extension
 98-05-08 10:05
 MODULE: 6.12
 DHE: B. B.

WINDOW H
 224/375.A12
 96/665.508

AUTO VOLUMES



EMME

91 LINKS

WINDOW B
 -282.2/372.876
 -13.73/ 529.28
 98-05-08 10:15
 MODULE: 5.12
 DATE: 05/08/98

EMME PROJECT: Corvallis-Philomath Study Area (62,500 population)
 SCENARIO: 801 2015-26th St. Extension

AUTO VOLUMES

Emme2

LINKS

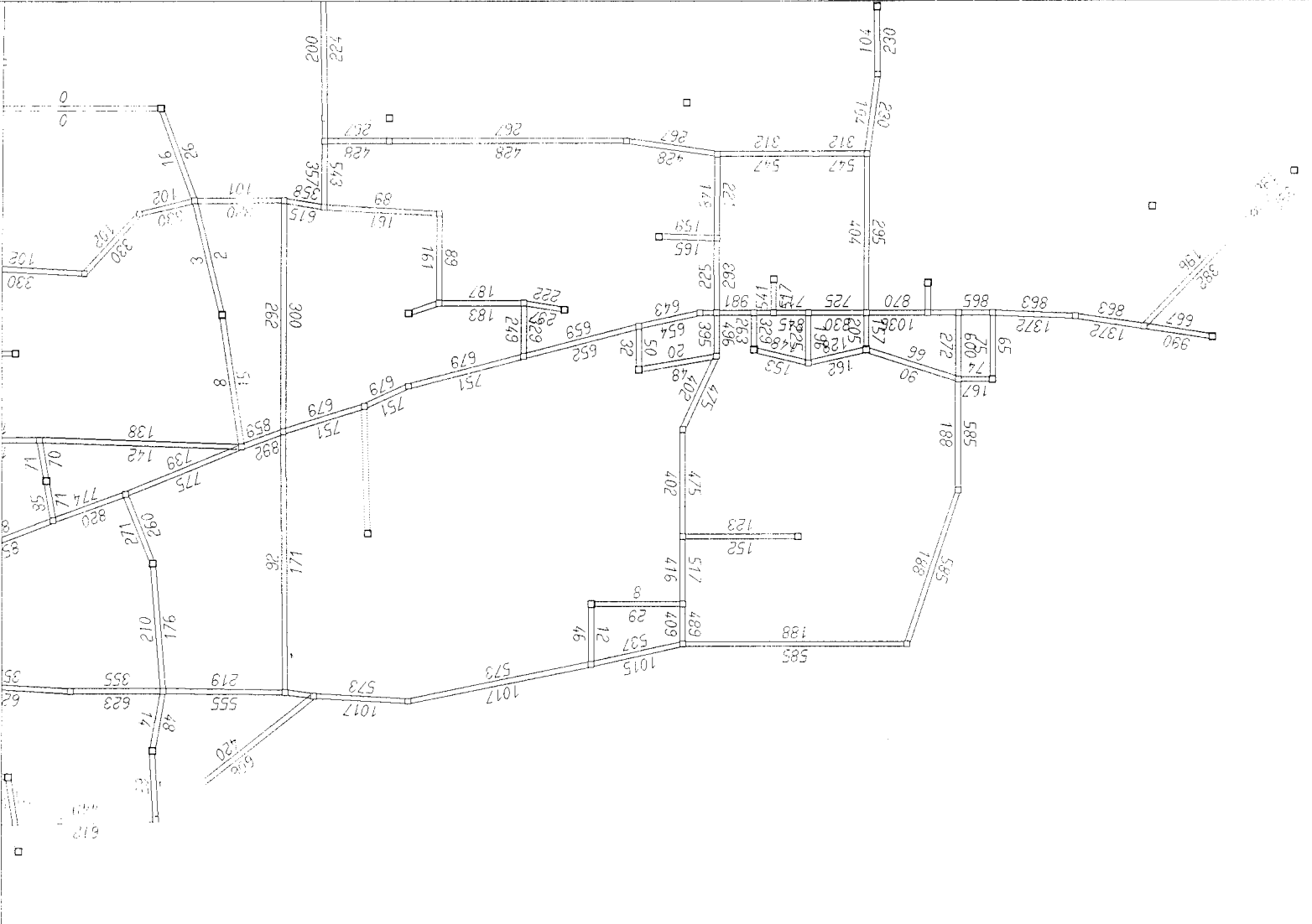

WINDOW #1
224/075 7
164/96/655/598

98-05-06 10:22
MODULE 612
DEF: B19

EXHIBIT PROJECT: Corvallis-Philomath Study Area (62,500 population)
SCENARIO: 80% 2015-71st St. Extension

DESCRIPTION OF LEVEL OF SERVICE METHODOLOGY

APPENDIX E DESCRIPTION OF LEVEL OF SERVICE METHODOLOGY

LEVEL OF SERVICE CONCEPT

Transportation engineers have established various standards for measuring the capacity and performance of an intersection or roadway. Each standard is associated with a particular level-of-service (LOS). The LOS concept requires consideration of factors that include travel speed, delay, frequency of interruption in traffic flow, relative freedom for traffic maneuvers, and driver comfort and convenience. Six standards have been established ranging from LOS A, where traffic is relatively free-flowing, to LOS F, where the intersection or street is totally saturated with traffic and movement is very difficult.

Various intersections within the Philomath study area were selected and analyzed for their operational character based on the traffic volumes found to occur during the p.m. peak hour for existing and future conditions. Signalized intersections were evaluated based on the overall average delay to all vehicles entering the intersection and the volume-to-capacity ratio. The unsignalized intersections were evaluated based on the availability of adequate gaps in the main street flow of traffic to safely accommodate the most critical movement from the side street approach.

Signalized Intersections

Regarding signalized intersections, the concept of level-of-service is a quantitative measure of the ratio between the existing or projected volumes to the capacity of the roadway at a given location. This ratio is known as Volume to Capacity (V/C). The V/C ratios are broken down further into the six LOS descriptions ranging from A to F, for operations identification purposes. The six LOS grades are described qualitatively for signalized intersections in **Table E-1**. Additionally, Table E-2 identifies the relationship between level of service and the V/C ratio. Under these criteria, a "D" LOS is generally considered to represent the minimum acceptable design standard.

Unsignalized Intersections

The operational characteristics of selected unsignalized intersections throughout the study area were assessed using ODOT's UNSIG-10 program. This program calculates delay and Level-of-Service for the critical movements of an intersection, based on the reserve capacity. Unsignalized intersections include Two-Way Stop-Controlled (TWSC) and All-Way Stop-Controlled (AWSC) intersections. A qualitative description of the various service levels associated with an unsignalized intersection is presented in Table E-3. Using the criteria in this table, LOS D is generally considered to represent the minimum acceptable design standard.

It should be noted that the LOS criteria for unsignalized intersections are somewhat different than the criteria used for signalized intersections. The primary reason for this difference is that drivers expect different levels of performance from different kinds of transportation facilities. The expectation is that a signalized intersection is designed to carry higher traffic volumes than an unsignalized intersection. Additionally, there are a number of driver behavior considerations that combine to make delays at signalized intersections less onerous than at unsignalized intersections. For example, drivers at signalized intersections are able to relax during the red interval, while drivers on the minor street approaches to TWSC intersections must remain attentive to the task of identifying acceptable gaps and vehicle conflicts. Also, there is often much more variability in the amount of delay experienced by individual drivers at unsignalized intersections than signalized intersections. For these reasons, it is considered that the total delay threshold for any given LOS is less for an unsignalized intersection than for a signalized intersection. **While overall intersection LOS is calculated for AWSC intersections, LOS is only calculated for the minor approaches and the major street left turn movements at TWSC intersections.** No delay is assumed to the major street through movements. For TWSC intersections, the overall intersection LOS is defined by the movement having the worst LOS (typically a minor street left turn).

**TABLE E-1
LEVEL OF SERVICE DESCRIPTION FOR
SIGNALIZED INTERSECTIONS**

Level-of-Service	Traffic Flow	Comments	Maneuverability
A Desirable	Free	Traffic flows freely with no delays.	Drivers can maneuver easily and find freedom in operation.
B Desirable	Stable	Traffic still flows smoothly with few delays.	Some drivers feel somewhat restricted within groups of vehicles.
C Desirable	Stable	Traffic generally flows smoothly but occasionally vehicles may be delayed through one signal cycle. Desired urban area design level.	Backups may develop behind turning vehicles. Most drivers feel somewhat restricted.
D Acceptable	Approaching Unstable	Traffic delays may be more than one signal cycle during peak hours but excessive back-ups do not occur. Considered acceptable urban area design level.	Maneuverability is limited during short peak periods due to temporary back-ups.
E Unsatisfactory	Unstable	Delay may be great and up to several signal cycles. Short periods of this level may be tolerated during peak hours in lieu of the cost and disruption attributed to providing a higher level of service.	There are typically long queues of vehicles waiting upstream of the intersections.
F Unsatisfactory	Forced	Excessive delay causes reduced capacity. Always considered unsatisfactory. May be tolerated in recreational areas where occurrence is rare.	Traffic is backed up from other locations and may restrict or prevent movement of vehicles at the intersection.

Source: ODOT, Transportation Development Branch, SIGCAP2 Users Manual, Page B-3.

**TABLE E-2
LEVEL-OF-SERVICE CRITERIA
FOR A SIGNALIZED INTERSECTION**

Level of Service	V/C Ratio
A	0.00-0.48
B	0.49-0.59
C	0.60-0.69
C-D	0.70-0.73
D	0.74-0.83
D-E	0.84-0.87
E	0.88-0.97
E-F	0.98-0.99
F	>1.00

Source: ODOT, Transportation Development Branch, SIGCAP2 Users Manual, page B-2.

**TABLE E-3
LEVEL-OF-SERVICE DESCRIPTIONS
FOR AN UNSIGNALIZED INTERSECTION**

Level of Service	Delay Range (seconds/vehicle)
A	<ul style="list-style-type: none"> Nearly all drivers find freedom of operation. Very seldom is there more than one vehicle in the queue.
B	<ul style="list-style-type: none"> Some drivers begin to consider the delay an inconvenience. Occasionally there is more than one vehicle in the queue.
C	<ul style="list-style-type: none"> Most drivers feel restricted, but not objectionably so. Many times there is more than one vehicle in the queue.
D	<ul style="list-style-type: none"> Drivers feel quite restricted. Often there is more than one vehicle in the queue.
E	<ul style="list-style-type: none"> Represents a condition in which the demand is near or equal to the probable maximum number of vehicles that can be accommodated by the movement. Drivers find the delays to be approaching intolerable levels. There is almost always more than one vehicle in the queue.
F	<ul style="list-style-type: none"> Forced flow. Represents an intersection failure condition that is caused by geometric and/or operational constraints external to the intersection.

SIGNAL WARRANT ANALYSIS

TRAFFIC SIGNAL WARRANTS

INTERSECTION INFORMATION					
City:	Philomath	Scenario:	1998 Existing		
Population:	3000				
Intersection Location: (Rural/Urban)	Urban				
Major Street Name:	Main St.	Minor Street Name:	9th St.		
Number of Moving Lanes for Each Approach:	1	Number of Moving Lanes for Each Approach:	1		
Speed:	35 mph	Speed:	25 mph		
Street Width:	48 ft	Street Width:	40 ft		
Direction:	EB*	WB*	Direction:	NB**	SB**
Hour Beginning:			Hour Beginning:		
12:00 AM			12:00 AM		
1:00 AM			1:00 AM		
2:00 AM			2:00 AM		
3:00 AM			3:00 AM		
4:00 AM			4:00 AM		
5:00 AM			5:00 AM		
6:00 AM	292	159	6:00 AM	0	35
7:00 AM	646	230	7:00 AM	0	94
8:00 AM	527	280	8:00 AM	0	66
9:00 AM	363	277	9:00 AM	0	25
10:00 AM	349	307	10:00 AM	0	28
11:00 AM	339	312	11:00 AM	0	31
12:00 PM	318	345	12:00 PM	0	23
1:00 PM	313	329	1:00 PM	0	32
2:00 PM	400	356	2:00 PM	0	18
3:00 PM	348	439	3:00 PM	0	28
4:00 PM	435	534	4:00 PM	0	39
5:00 PM	361	569	5:00 PM	0	42
6:00 PM			6:00 PM		
7:00 PM			7:00 PM		
8:00 PM			8:00 PM		
9:00 PM			9:00 PM		
10:00 PM			10:00 PM		
11:00 PM			11:00 PM		
24-hour Total	4691	4137	24-hour Total	0	461

* - EB and WB traffic volumes were estimated using the 12-hour turning movement count performed at the intersection of Highway 20 and Highway 34 to the west.

** - NB and SB traffic volumes were taken from a road tube count performed in September 1997.

TRAFFIC SIGNAL WARRANTS

WARRANT 1, MINIMUM VEHICULAR VOLUME (8 HOURS)						
4:00 PM	435	534	4:00 PM	0	39	N
5:00 PM	361	569	5:00 PM	0	42	N
7:00 AM	646	230	7:00 AM	0	94	N
8:00 AM	527	280	8:00 AM	0	66	N
3:00 PM	348	439	3:00 PM	0	28	N
2:00 PM	400	356	2:00 PM	0	18	N
12:00 PM	318	345	12:00 PM	0	23	N
10:00 AM	349	307	10:00 AM	0	28	N
11:00 AM	339	312	11:00 AM	0	31	N
1:00 PM	313	329	1:00 PM	0	32	N
9:00 AM	363	277	9:00 AM	0	25	N
6:00 AM	292	159	6:00 AM	0	35	N
Warrant Requirements:						
Major Street Lanes:	1					
Minor Street Lanes:	1					
Minimum Volume on Combined Major Street Approaches:	350		Note: The intersection is located in an urban area of a community with a population of less than 10,000, therefore these minimum volumes are 70 percent of the regular requirements			
Higher Minor Street Approach:	105					
IS THE SIGNAL WARRANT MET?		NO				

WARRANT 2, INTERRUPTION OF CONTINUOUS TRAFFIC (8 HOURS)						
4:00 PM	435	534	4:00 PM	0	39	N
5:00 PM	361	569	5:00 PM	0	42	N
7:00 AM	646	230	7:00 AM	0	94	Y
8:00 AM	527	280	8:00 AM	0	66	Y
3:00 PM	348	439	3:00 PM	0	28	N
2:00 PM	400	356	2:00 PM	0	18	N
12:00 PM	318	345	12:00 PM	0	23	N
10:00 AM	349	307	10:00 AM	0	28	N
11:00 AM	339	312	11:00 AM	0	31	N
1:00 PM	313	329	1:00 PM	0	32	N
9:00 AM	363	277	9:00 AM	0	25	N
6:00 AM	292	159	6:00 AM	0	35	N
Warrant Requirements:						
Major Street Lanes:	1					
Minor Street Lanes:	1					
Minimum Volume on Combined Major Street Approaches:	525		Note: The intersection is located in an urban area of a community with a population of less than 10,000, therefore these minimum volumes are 70 percent of the regular requirements			
Higher Minor Street Approach:	53					
IS THE SIGNAL WARRANT MET?		NO				

TRAFFIC SIGNAL WARRANTS

WARRANT 3, MINIMUM PEDESTRIAN VOLUME (4 HOURS)						
4:00 PM	435	534	38	4:00 PM	0	39
5:00 PM	361	569	42	5:00 PM	0	42
7:00 AM	646	230	47	7:00 AM	0	94
8:00 AM	527	280	55	8:00 AM	0	66
Warrant Requirements:						
Major Street Lanes:	1					
Major Street Speed:	35 mph					
Major Street Critical Gap:	12.0 s					
Minor Street Lanes:	1					
IS THE SIGNAL WARRANT MET?			YES, PARTIALLY			
<p>Note: This warrant calculation examines only one part of the pedestrian warrant. In addition to checking the number of gaps available for pedestrians to cross the street, minimum pedestrian volumes are also necessary. A traffic signal may be warranted where the pedestrian volume crossing the major street at an intersection or mid-block location during an average day is 100 or more for each of any four hours or 190 or more during any one hour.</p>						

WARRANT 4, SCHOOL CROSSING
This warrant is not analyzed as part of the signal warrant calculations.

WARRANT 5, PROGRESSIVE MOVEMENT
This warrant is not analyzed as part of the signal warrant calculations.

WARRANT 6, ACCIDENT EXPERIENCE
This warrant is not analyzed as part of the signal warrant calculations.

WARRANT 7, SYSTEMS WARRANT
This warrant is not analyzed as part of the signal warrant calculations.

WARRANT 8, COMBINATION OF WARRANTS
This warrant is not analyzed as part of the signal warrant calculations.

TRAFFIC SIGNAL WARRANTS

WARRANT 9, FOUR HOUR VOLUMES							
4:00 PM	435	534	60	4:00 PM	0	39	N
5:00 PM	361	569	60	5:00 PM	0	42	N
7:00 AM	646	230	60	7:00 AM	0	94	Y
8:00 AM	527	280	60	8:00 AM	0	66	Y
3:00 PM	348	439	60	3:00 PM	0	28	N
2:00 PM	400	356	60	2:00 PM	0	18	N
12:00 PM	318	345	70	12:00 PM	0	23	N
10:00 AM	349	307	70	10:00 AM	0	28	N
Warrant Requirements:							
Major Street Lanes:	1						
Minor Street Lanes:	1						
<p>Note: The intersection is located in an urban area of a community with a population of less than 10,000, therefore Figure 4-8 from the MUTCD was used for the warrant analysis instead of Figure 4-7.</p>							
IS THE SIGNAL WARRANT MET?			NO				

WARRANT 10, PEAK HOUR DELAY	
This warrant is not analyzed as part of the signal warrant calculations.	

WARRANT 11, PEAK HOUR VOLUME							
4:00 PM	435	534	80	4:00 PM	0	39	N
5:00 PM	361	569	90	5:00 PM	0	42	N
7:00 AM	646	230	90	7:00 AM	0	94	Y
8:00 AM	527	280	110	8:00 AM	0	66	N
Warrant Requirements:							
Major Street Lanes:	1						
Minor Street Lanes:	1						
<p>Note: The intersection is located in an urban area of a community with a population of less than 10,000, therefore figure 4-6 from the MUTCD was used for the warrant analysis instead of figure 4-5.</p>							
IS THE SIGNAL WARRANT MET?			YES				

TRAFFIC SIGNAL WARRANTS

INTERSECTION INFORMATION					
City:	Philomath	Scenario:	2015- No Build		
Population:	3000				
Intersection Location: (Rural/Urban)	Urban				
Major Street Name:	Main St.	Minor Street Name:	9th St.		
Number of Moving Lanes for Each Approach:	1	Number of Moving Lanes for Each Approach:	1		
Speed:	35 mph	Speed:	25 mph		
Street Width:	48 ft	Street Width:	40 ft		
Direction:	EB* WB*	Direction:	NB** SB**		
Hour Beginning:		Hour Beginning:			
12:00 AM		12:00 AM			
1:00 AM		1:00 AM			
2:00 AM		2:00 AM			
3:00 AM		3:00 AM			
4:00 AM		4:00 AM			
5:00 AM		5:00 AM			
6:00 AM	702 246	6:00 AM	0 217		
7:00 AM	1001 357	7:00 AM	0 583		
8:00 AM	817 434	8:00 AM	0 409		
9:00 AM	563 429	9:00 AM	0 155		
10:00 AM	541 476	10:00 AM	0 174		
11:00 AM	525 484	11:00 AM	0 192		
12:00 PM	493 535	12:00 PM	0 143		
1:00 PM	485 510	1:00 PM	0 198		
2:00 PM	620 552	2:00 PM	0 112		
3:00 PM	539 680	3:00 PM	0 174		
4:00 PM	674 828	4:00 PM	0 612		
5:00 PM	560 882	5:00 PM	0 260		
6:00 PM		6:00 PM			
7:00 PM		7:00 PM			
8:00 PM		8:00 PM			
9:00 PM		9:00 PM			
10:00 PM		10:00 PM			
11:00 PM		11:00 PM			
24-hour Total	7520 6413	24-hour Total	0 3229		

*- EB and WB traffic volumes were estimated using 1998 volumes increased by growth factors of 1.54 for EB traf and 1.60 for WB traffic. Growth factors were determined from EMME/2 model output.

** - SB traffic volumes were estimated using 1998 volumes increased by a growth factor of 6.24. This growth fa was also determined from EMME/2 model output.

TRAFFIC SIGNAL WARRANTS

WARRANT 1, MINIMUM VEHICULAR VOLUME (8 HOURS)						
4:00 PM	674	828	4:00 PM	0	612	Y
7:00 AM	1001	357	7:00 AM	0	583	Y
5:00 PM	560	882	5:00 PM	0	260	Y
12:00 AM	0	0	12:00 AM	0	0	N
8:00 AM	817	434	8:00 AM	0	409	Y
3:00 PM	539	680	3:00 PM	0	174	Y
2:00 PM	620	552	2:00 PM	0	112	Y
11:00 AM	525	484	11:00 AM	0	192	Y
1:00 PM	485	510	1:00 PM	0	198	Y
11:00 AM	525	484	11:00 AM	0	192	Y
1:00 PM	485	510	1:00 PM	0	198	Y
6:00 AM	702	246	6:00 AM	0	217	Y
Warrant Requirements:						
Major Street Lanes:	1					
Minor Street Lanes:	1					
Minimum Volume on Combined Major Street Approaches:	350		Note: The intersection is located in an urban area of a community with a population of less than 10,000, therefore these minimum volumes are 70 percent of the regular requirements			
Higher Minor Street Approach:	105					
IS THE SIGNAL WARRANT MET?		YES				

WARRANT 2, INTERRUPTION OF CONTINUOUS TRAFFIC (8 HOURS)						
4:00 PM	674	828	4:00 PM	0	612	Y
7:00 AM	1001	357	7:00 AM	0	583	Y
5:00 PM	560	882	5:00 PM	0	260	Y
12:00 AM	0	0	12:00 AM	0	0	N
8:00 AM	817	434	8:00 AM	0	409	Y
3:00 PM	539	680	3:00 PM	0	174	Y
2:00 PM	620	552	2:00 PM	0	112	Y
11:00 AM	525	484	11:00 AM	0	192	Y
1:00 PM	485	510	1:00 PM	0	198	Y
11:00 AM	525	484	11:00 AM	0	192	Y
1:00 PM	485	510	1:00 PM	0	198	Y
6:00 AM	702	246	6:00 AM	0	217	Y
Warrant Requirements:						
Major Street Lanes:	1					
Minor Street Lanes:	1					
Minimum Volume on Combined Major Street Approaches:	525		Note: The intersection is located in an urban area of a community with a population of less than 10,000, therefore these minimum volumes are 70 percent of the regular requirements			
Higher Minor Street Approach:	53					
IS THE SIGNAL WARRANT MET?		YES				

TRAFFIC SIGNAL WARRANTS

WARRANT 3, MINIMUM PEDESTRIAN VOLUME (4 HOURS)						
4:00 PM	674	828	10	4:00 PM	0	612
7:00 AM	1001	357	15	7:00 AM	0	583
5:00 PM	560	882	12	5:00 PM	0	260
12:00 AM	0	0	0	12:00 AM	0	0
Warrant Requirements:						
Major Street Lanes:	1					
Major Street Speed:	35 mph					
Major Street Critical Gap:	12.0 s					
Minor Street Lanes:	1					
IS THE SIGNAL WARRANT MET?			YES, PARTIALLY			
<p>Note: This warrant calculation examines only one part of the pedestrian warrant. In addition to checking the number of gaps available for pedestrians to cross the street, minimum pedestrian volumes are also necessary. A traffic signal may be warranted where the pedestrian volume crossing the major street at an intersection or mid-block location during an average day is 100 or more for each of any four hours or 190 or more during any one hour.</p>						

WARRANT 4, SCHOOL CROSSING

This warrant is not analyzed as part of the signal warrant calculations.

WARRANT 5, PROGRESSIVE MOVEMENT

This warrant is not analyzed as part of the signal warrant calculations.

WARRANT 6, ACCIDENT EXPERIENCE

This warrant is not analyzed as part of the signal warrant calculations.

WARRANT 7, SYSTEMS WARRANT

This warrant is not analyzed as part of the signal warrant calculations.

WARRANT 8, COMBINATION OF WARRANTS

This warrant is not analyzed as part of the signal warrant calculations.

TRAFFIC SIGNAL WARRANTS

WARRANT 9, FOUR HOUR VOLUMES							
4:00 PM	674	828	60	4:00 PM	0	612	Y
7:00 AM	1001	357	60	7:00 AM	0	583	Y
5:00 PM	560	882	60	5:00 PM	0	260	Y
12:00 AM	0	0	#N/A	12:00 AM	0	0	#N/A
8:00 AM	817	434	60	8:00 AM	0	409	Y
3:00 PM	539	680	60	3:00 PM	0	174	Y
2:00 PM	620	552	60	2:00 PM	0	112	Y
11:00 AM	525	484	60	11:00 AM	0	192	Y
Warrant Requirements:							
Major Street Lanes:	1						
Minor Street Lanes:	1						
<p>Note: The intersection is located in an urban area of a community with a population of less than 10,000, therefore Figure 4-8 from the MUTCD was used for the warrant analysis instead of Figure 4-7.</p>							
IS THE SIGNAL WARRANT MET?			YES				

WARRANT 10, PEAK HOUR DELAY	
This warrant is not analyzed as part of the signal warrant calculations.	

WARRANT 11, PEAK HOUR VOLUME							
4:00 PM	674	828	75	4:00 PM	0	612	Y
7:00 AM	1001	357	75	7:00 AM	0	583	Y
5:00 PM	560	882	75	5:00 PM	0	260	Y
12:00 AM	0	0	#N/A	12:00 AM	0	0	#N/A
Warrant Requirements:							
Major Street Lanes:	1						
Minor Street Lanes:	1						
<p>Note: The intersection is located in an urban area of a community with a population of less than 10,000, therefore figure 4-6 from the MUTCD was used for the warrant analysis instead of figure 4-5.</p>							
IS THE SIGNAL WARRANT MET?			YES				

DETAILS OF OPERATIONS ANALYSIS AT INTERSECTIONS

**INTERSECTION 1
SCENARIO 1
JUNE 3, 1998**

INTERSECTION = 1 SCENARIO = 1 DATE/TIME: 6/3/98 11:26:52 AM

PROJECT: Philomath TSP ANALYST: BJD
 File: S:\TRANS\PROJECT\ODOT0254\WORKFILE\OPERATIO\SIGOPER.SIG
 CITY: Philomath PHILMATH: Philomath 20,000
 DESCRIPTION: 1998 Existing Conditions

INTERSECTION LOS = B
 SATURATION = 59%

C= 90 G=81 Y= 9

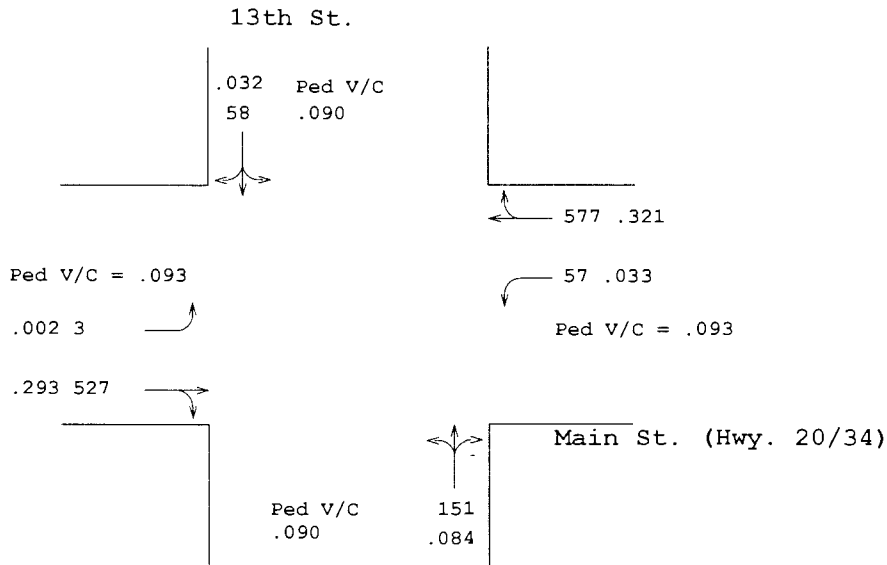

N-S V/C = .099
 E-W V/C = .387
 TOTAL AMBER = .100
 MINIMUM V/C = .067

XXX = Adjusted Volumes .XXX = V/C

APPR	MOVMENT VOLUMES				MOVE SATURATION			MOVEMENT LOS		
	L	T	R	TOT	L	T	R	L	T	R
SOUTH	83	11	57	151	59%	59%	51%	B	B	B
NORTH	27	18	13	58	59%	59%	26%	B	B	A
WEST	3	466	13	482	11%	54%	54%	A	B	B
EAST	57	571	6	634	34%	59%	59%	A	B	B

APPR	TRUCKS %	PED DIST	LANE WIDTH	PHASING
				SOUTH
NORTH	2.0%	50ft	12.ft	
WEST	15.0%	48ft	12.ft	E-W -LEFT TURNS PROTECTED WITH OVERLAP
EAST	5.0%	48ft	12.ft	

LEG	LEG VOL AT LOS C	APPR	TIME AVAIL(sec)			RED TIME(sec)			MOVE STORAGE(ft)		
			L	T	R	L	T	R	L	T	R
SOUTH	305	SOUTH	16.5	16.5	16.5	70.5	70.5	70.5	154	154	154
NORTH	99	NORTH	16.5	16.5	16.5	70.5	70.5	70.5	59	59	59
WEST	1464	WEST	11.1	53.4	53.4	75.9	33.6	33.6	4	268	268
EAST	1509	EAST	11.1	53.4	53.4	75.9	33.6	33.6	62	294	294

INTERSECTION = 2 SCENARIO = 1 DATE/TIME: 6/3/98 11:26:10 AM

PROJECT: Philomath TSP ANALYST: BJD
 File: S:\TRANS\PROJECT\ODOT0254\WORKFILE\OPERATIO\SIGOPER.SIG
 CITY: Philomath PERMITTED: PMw@eaKhan 20,000
 DESCRIPTION: 1998 Existing Conditions

INTERSECTION LOS = C
 SATURATION = 63%

C= 90 G=81 Y= 9

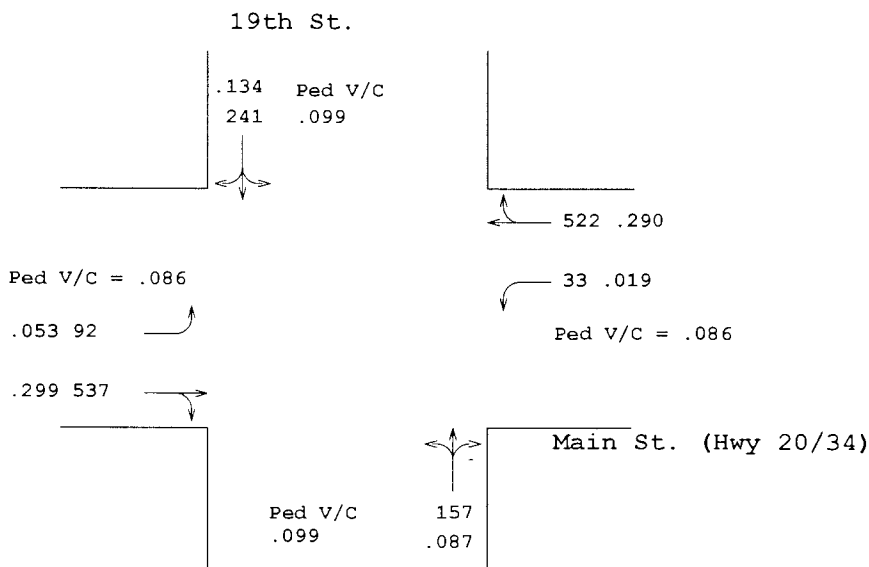

N-S V/C = .169
 E-W V/C = .365
 TOTAL AMBER = .100
 MINIMUM V/C = .067

XXX = Adjusted Volumes .XXX = V/C

APPR	MOVMENT VOLUMES				MOVE SATURATION			MOVEMENT LOS		
	L	T	R	TOT	L	T	R	L	T	R
SOUTH	61	43	53	157	63%	63%	38%	C	C	A
NORTH	37	63	132	232	63%	63%	52%	C	C	B
WEST	84	458	35	577	52%	63%	63%	B	C	C
EAST	31	466	22	519	25%	62%	62%	A	C	C

APPR	TRUCKS %	PED DIST	LANE WIDTH	PHASING
SOUTH	5.0%	22ft	12.ft	N-S -LEFT TURNS NOT PROTECTED
NORTH	9.0%	40ft	12.ft	
WEST	14.0%	48ft	12.ft	E-W -LEFT TURNS PROTECTED WITH OVERLAP
EAST	12.0%	48ft	12.ft	

LEG	LEG VOL AT LOS C	APPR	TIME AVAIL(sec)			RED TIME(sec)			MOVE STORAGE(ft)		
			L	T	R	L	T	R	L	T	R
SOUTH	332	SOUTH	25.6	25.6	25.6	61.4	61.4	61.4	140	140	140
NORTH	442	NORTH	25.6	25.6	25.6	61.4	61.4	61.4	216	216	216
WEST	1434	WEST	10.1	45.3	45.3	76.9	41.7	41.7	102	334	334
EAST	1238	EAST	10.1	45.3	45.3	76.9	41.7	41.7	37	324	324

UNSIGNALIZED - T - INTERSECTION CAPACITY CALCULATION FORM

5/ 4/1998 16:37:40

FILE NAME: hy2034ex

CITY: Philomath ANALYST: BJD
 INTERSECTION: Highway 20 at Highway 34
 ALTERNATE: 1998 Existing METRO SIZE: LESS THAN 20,000
 COUNT: PM Peak TYPE OF CONTROL: STOP
 LOCATION PLAN:

APPROACH CODES ARE

LANE	1	2	3	4	-----	
A	4			A		B
B	2	3				
C	1	3			GRADE= .0%	GRADE= .0%
						GRADE= .0%

SPEED: 45 MPH
 RESTRICTED SIGHT CODE IS 1
 MINOR STREET ADJUSTMENTS -
 ACCELERATION LANE? NO
 CURB RADIUS OR TURN ANGLE? NO

APPROACH	A		B		C	
MOVE	AT	AR	BL	BT	CL	CR
VOLUME	267	9	240	314	10	160
PCH			264		11	176
LANES	1			2		2

STEP 1 RIGHT TURN FROM C CR
 CONFLICTING FLOWS = MH = 272. VPH
 CRITICAL GAP = TG = 6.0 SECS
 POTENTIAL CAPACITY = M1 = 725. PCH
 SHARED LANE - SEE STEP 3
 NO SHARED LANE DEMAND = 176 PCH
 AVAILABLE RESERVE = 549. PCH
 DELAY & LOS = A

STEP 2 LEFT TURN FROM B BL
 CONFLICTING FLOWS = MH = 276. VPH
 CRITICAL GAP = TG = 5.5 SECS
 POTENTIAL CAPACITY = M2 = 806. PCH
 DEMAND = BL = 264 PCH
 CAPACITY USED = 32.74 %
 IMPEDANCE FACTOR = P2 = .749
 AVAILABLE RESERVE = 542. PCH
 DELAY & LOS = A

STEP 3 LEFT TURN FROM C CL
 CONFLICTING FLOWS = MH = 826. VPH
 CRITICAL GAP = TG = 6.5 SECS
 POTENTIAL CAPACITY = M3 = 296. PCH
 ADJUSTING FOR IMPEDANCE = M3 = 222. PCH

STEP 3 CONTINUED

CL

NO SHARED LANE DEMAND = 11 PCH
AVAILABLE RESERVE = 211. PCH
DELAY & LOS = C

SHARED LANE DEMAND = 0 PCH
POTENTIAL CAPACITY = M13 = 0. PCH
AVAILABLE RESERVE = 0. PCH
DELAY & LOS = N/A

LOS C VOLUMES:
VEHICLES PER HOUR

LEG C
392.

VER 03/93

UNSIGNALIZED INTERSECTION CAPACITY CALCULATION FORM

4-WAY INTERSECTION

5/13/1998 16:30:52

FILE NAME: main9ex

CITY: Philomath
 INTERSECTION: Main St. at 9th St.
 ALTERNATE: Existing Cond.
 COUNT: PM Peak
 LOCATION PLAN:

ANALYST: bjd
 METRO SIZE: LESS THAN 20,000
 TYPE OF CONTROL: STOP

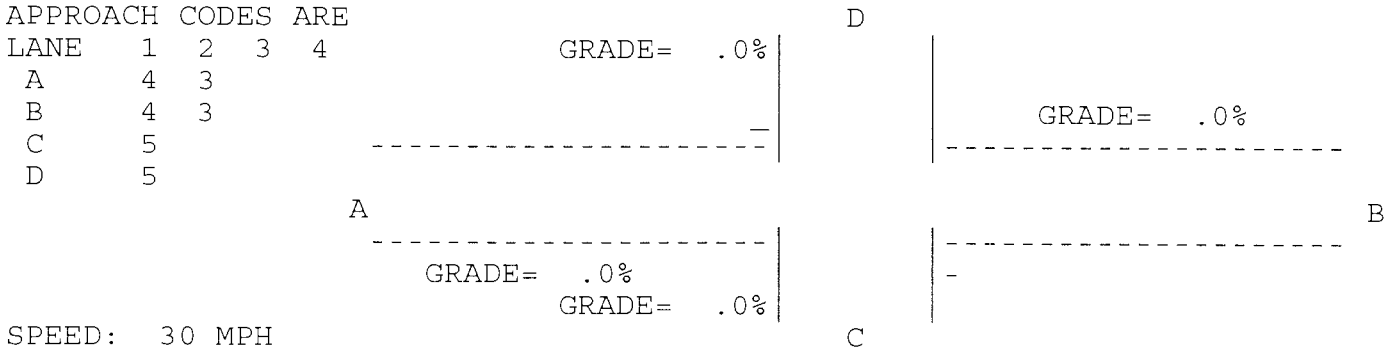

SPEED: 30 MPH
 RESTRICTED SIGHT CODE IS 1
 MINOR STREET ADJUSTMENTS -
 ACCELERATION LANE? NO
 CURB RADIUS OR TURN ANGLE? NO

APPR	A			B			C			D		
MOVE	AL	AT	AR	BL	BT	BR	CL	CT	CR	DL	DT	DR
VOL	5	550	5	5	795	32	5	5	5	30	5	70
PCH	6			6			6	6	6	33	6	77
LANES	2			2			1			1		

STEP 1 RIGHT TURN FROM C/D

CONFLICTING FLOWS = MH =	CR	DR
CRITICAL GAP = TG =	553.	811. VPH
POTENTIAL CAPACITY = M1 =	5.5	5.5 SECS
DEMAND =	579.	420. PCH
CAPACITY USED =	6	77 PCH
IMPEDANCE FACTOR =	1.037	18.337 %
	.994	.868

SHARED LANE - SEE STEP 3

NO SHARED LANE - RESERVE =	0.	0. PCH
DELAY & LOS =	N/A	N/A

STEP 2 - LEFT TURNS FROM B/A

CONFLICTING FLOWS = MH =	BL	AL
CRITICAL GAP = TG =	555.	827. VPH
POTENTIAL CAPACITY = M2 =	5.0	5.0 SECS
DEMAND =	670.	490. PCH
CAPACITY USED =	6	6 PCH
IMPEDANCE FACTOR =	.90	1.22 %
AVAILABLE RESERVE =	.995	.993
DELAY & LOS =	664.	484. PCH
	A	A

STEP 3	THRU MOVEMENT FROM C/D	CT	DT
	CONFLICTING FLOWS = MT =	1390.	1376. VPH
	CRITICAL GAP = TG =	6.0	6.0 SECS
	POTENTIAL CAPACITY = MN3 =	149.	153. PCH
	IMPEDANCE ADJUSTMENT = M3 =	148.	151. PCH
	DEMAND =	6	6 PCH
	CAPACITY USED =	4.01	3.93 %
	IMPEDANCE FACTOR = P3 =	.974	.974

NO SHARED LANE		
AVAILABLE RESERVE=	0.	0. PCH
DELAY & LOS =	N/A	N/A

SHARED LANE WITH LEFT TURN - SEE STEP 4

SHARED LANE DEMAND =	0	0 PCH
POTENTIAL CAPACITY = M13 =	0.	0. PCH
AVAILABLE RESERVE =	0.	0. PCH
DELAY & LOS =	N/A	N/A

STEP 4 - LEFT TURN FROM C/D	CL	DL
CONFLICTING FLOWS = MH =	1465.	1386. VPH
CRITICAL GAP = TG =	6.0	6.0 SECS
POTENTIAL CAPACITY = MN =	133.	150. PCH
ADJUST FOR IMPEDANCE:	111.	144. PCH

NO SHARED LANE DEMAND =	0	0 PCH
AVAILABLE RESERVE =	0.	0. PCH
DELAY & LOS =	N/A	N/A

WITH LEFT & THRU		
SHARED LANE DEMAND =	0	0 PCH
CAPACITY OF SHARED LANE =	0.	0. PCH
AVAILABLE RESERVE =	0.	0. PCH
DELAY & LOS =	N/A	N/A

WITH LEFT, THRU, & RIGHT		
SHARED LANE DEMAND =	18	116 PCH
CAPACITY OF SHARED LANE =	172.	256. PCH
AVAILABLE RESERVE =	154.	140. PCH
DELAY & LOS =	D	D

LOS C VOLUMES:
VEHICLES PER HOUR

FOR LEG C
27.

FOR LEG D
27.

UNSIGNALIZED - T - INTERSECTION CAPACITY CALCULATION FORM

5/13/1998 12:54:33

FILE NAME: main26ex

CITY: Philomath ANALYST: BJD
 INTERSECTION: Main St. at 26th St.
 ALTERNATE: Existing Cond. METRO SIZE: LESS THAN 20,000
 COUNT: PM Peak TYPE OF CONTROL: STOP
 LOCATION PLAN:

APPROACH CODES ARE

LANE	1	2	3	4	-----		
A	4			A			B
B	6						
C	7						

	GRADE=	.0%				GRADE=	.0%
						GRADE=	.0%

SPEED: 40 MPH
 RESTRICTED SIGHT CODE IS 1
 MINOR STREET ADJUSTMENTS -
 ACCELERATION LANE? NO
 CURB RADIUS OR TURN ANGLE? NO

APPROACH	A		B		C	
MOVE	AT	AR	BL	BT	CL	CR
VOLUME	530	20	25	700	20	20
PCH			28		22	22
LANES	1			1		1

STEP 1 RIGHT TURN FROM C CR
 CONFLICTING FLOWS = MH = 540. VPH
 CRITICAL GAP = TG = 6.0 SECS
 POTENTIAL CAPACITY = M1 = 509. PCH
 SHARED LANE - SEE STEP 3
 NO SHARED LANE DEMAND = 0 PCH
 AVAILABLE RESERVE = 0. PCH
 DELAY & LOS = N/A

STEP 2 LEFT TURN FROM B BL
 CONFLICTING FLOWS = MH = 550. VPH
 CRITICAL GAP = TG = 5.5 SECS
 POTENTIAL CAPACITY = M2 = 580. PCH
 DEMAND = BL = 28 PCH
 CAPACITY USED = 4.82 %
 IMPEDANCE FACTOR = P2 = .968
 AVAILABLE RESERVE = 552. PCH
 DELAY & LOS = A

STEP 3 LEFT TURN FROM C CL
 CONFLICTING FLOWS = MH = 1265. VPH
 CRITICAL GAP = TG = 6.5 SECS
 POTENTIAL CAPACITY = M3 = 142. PCH
 ADJUSTING FOR IMPEDANCE = M3 = 138. PCH

STEP 3 CONTINUED

CL

NO SHARED LANE DEMAND =	0 PCH
AVAILABLE RESERVE =	0. PCH
DELAY & LOS =	N/A
SHARED LANE DEMAND =	44 PCH
POTENTIAL CAPACITY = M13 =	217. PCH
AVAILABLE RESERVE =	173. PCH
DELAY & LOS =	D

LOS C VOLUMES:
VEHICLES PER HOUR

LEG C
75.

VER 03/93

STEP 3	THRU MOVEMENT FROM C/D	CT	DT
	CONFLICTING FLOWS = MT =	188.	197. VPH
	CRITICAL GAP = TG =	6.0	6.0 SECS
	POTENTIAL CAPACITY = MN3 =	806.	796. PCH
	IMPEDANCE ADJUSTMENT = M3 =	785.	776. PCH
	DEMAND =	92	76 PCH
	CAPACITY USED =	11.42	9.55 %
	IMPEDANCE FACTOR = P3 =	.921	.934

NO SHARED LANE		
AVAILABLE RESERVE=	0.	0. PCH
DELAY & LOS =	N/A	N/A

SHARED LANE WITH LEFT TURN - SEE STEP 4

SHARED LANE DEMAND =	0	0 PCH
POTENTIAL CAPACITY = M13 =	0.	0. PCH
AVAILABLE RESERVE =	0.	0. PCH
DELAY & LOS =	N/A	N/A

STEP 4 -	LEFT TURN FROM C/D	CL	DL
	CONFLICTING FLOWS = MH =	304.	302. VPH
	CRITICAL GAP = TG =	6.0	6.0 SECS
	POTENTIAL CAPACITY = MN =	696.	697. PCH
	ADJUST FOR IMPEDANCE:	612.	616. PCH

NO SHARED LANE DEMAND =	0	0 PCH
AVAILABLE RESERVE =	0.	0. PCH
DELAY & LOS =	N/A	N/A

WITH LEFT & THRU		
SHARED LANE DEMAND =	0	0 PCH
CAPACITY OF SHARED LANE =	0.	0. PCH
AVAILABLE RESERVE =	0.	0. PCH
DELAY & LOS =	N/A	N/A

WITH LEFT, THRU, & RIGHT		
SHARED LANE DEMAND =	157	174 PCH
CAPACITY OF SHARED LANE =	753.	779. PCH
AVAILABLE RESERVE =	596.	605. PCH
DELAY & LOS =	A	A

LOS C VOLUMES:	FOR LEG C	FOR LEG D
VEHICLES PER HOUR	530.	533.

UNSIGNALIZED INTERSECTION CAPACITY CALCULATION FORM

4-WAY INTERSECTION

5/ 4/1998 16:23:27

FILE NAME: app19ex

CITY: Philomath

ANALYST: BJD

INTERSECTION: Applegate St. at 19th St.

ALTERNATE: 1998 Existing

METRO SIZE: LESS THAN 20,000

COUNT: PM Peak

TYPE OF CONTROL: STOP

LOCATION PLAN:

APPROACH CODES ARE

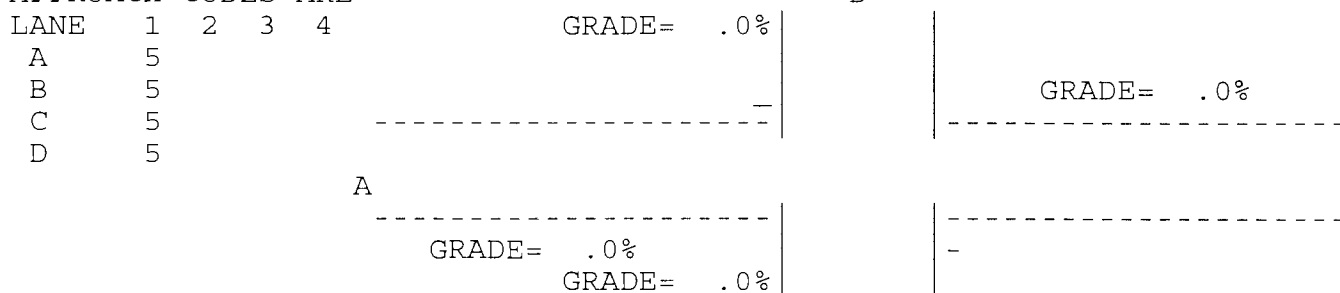

SPEED: 25 MPH

RESTRICTED SIGHT CODE IS 1

MINOR STREET ADJUSTMENTS -

ACCELERATION LANE? NO

CURB RADIUS OR TURN ANGLE? NO

APPR	A			B			C			D		
MOVE	AL	AT	AR	BL	BT	BR	CL	CT	CR	DL	DT	DR
VOL	24	77	51	22	53	8	16	39	18	27	30	27
PCH	26			24			18	43	20	30	33	30
LANES		1			1			1			1	

STEP 1 RIGHT TURN FROM C/D

CONFLICTING FLOWS = MH =	103.	57. VPH
CRITICAL GAP = TG =	5.5	5.5 SECS
POTENTIAL CAPACITY = M1 =	985.	1037. PCH
DEMAND =	20	30 PCH
CAPACITY USED =	2.031	2.893 %
IMPEDANCE FACTOR =	.987	.981

SHARED LANE - SEE STEP 3

NO SHARED LANE - RESERVE =	0.	0. PCH
DELAY & LOS =	N/A	N/A

STEP 2 - LEFT TURNS FROM B/A

CONFLICTING FLOWS = MH =	128.	61. VPH
CRITICAL GAP = TG =	5.0	5.0 SECS
POTENTIAL CAPACITY = M2 =	1057.	1131. PCH
DEMAND =	24	26 PCH
CAPACITY USED =	2.27	2.30 %
IMPEDANCE FACTOR =	.985	.985
AVAILABLE RESERVE =	1033.	1105. PCH
DELAY & LOS =	A	A

STEP 3	THRU MOVEMENT FROM C/D	CT	DT
	CONFLICTING FLOWS = MT =	210.	231. VPH
	CRITICAL GAP = TG =	6.0	6.0 SECS
	POTENTIAL CAPACITY = MN3 =	784.	763. PCH
	IMPEDANCE ADJUSTMENT = M3 =	761.	741. PCH
	DEMAND =	43	33 PCH
	CAPACITY USED =	5.49	4.33 %
	IMPEDANCE FACTOR = P3 =	.963	.971

NO SHARED LANE		
AVAILABLE RESERVE =	0.	0. PCH
DELAY & LOS =	N/A	N/A

SHARED LANE WITH LEFT TURN - SEE STEP 4

SHARED LANE DEMAND =	0	0 PCH
POTENTIAL CAPACITY = M13 =	0.	0. PCH
AVAILABLE RESERVE =	0.	0. PCH
DELAY & LOS =	N/A	N/A

STEP 4 - LEFT TURN FROM C/D	CL	DL
CONFLICTING FLOWS = MH =	267.	288. VPH
CRITICAL GAP = TG =	6.0	6.0 SECS
POTENTIAL CAPACITY = MN =	729.	710. PCH
ADJUST FOR IMPEDANCE:	675.	655. PCH

NO SHARED LANE DEMAND =	0	0 PCH
AVAILABLE RESERVE =	0.	0. PCH
DELAY & LOS =	N/A	N/A

WITH LEFT & THRU		
SHARED LANE DEMAND =	0	0 PCH
CAPACITY OF SHARED LANE =	0.	0. PCH
AVAILABLE RESERVE =	0.	0. PCH
DELAY & LOS =	N/A	N/A

WITH LEFT, THRU, & RIGHT		
SHARED LANE DEMAND =	81	93 PCH
CAPACITY OF SHARED LANE =	783.	780. PCH
AVAILABLE RESERVE =	702.	687. PCH
DELAY & LOS =	A	A

LOS C VOLUMES:	FOR LEG C	FOR LEG D
VEHICLES PER HOUR	492.	452.

**INTERSECTION 1
SCENARIO 2
OCTOBER 12, 1998**

PROJECT: Philomath TSP ANALYST: BJD
 File: S:\TRANS\PROJECT\ODOT0254\WORKFILE\OPERATIO\SIGOPER.SIG
 CITY: Philomath PERKLAUBN: PwSeKhan 20,000
 DESCRIPTION: 2015 No Build

INTERSECTION LOS = D
 SATURATION = 81%

C= 90 G=81 Y= 9

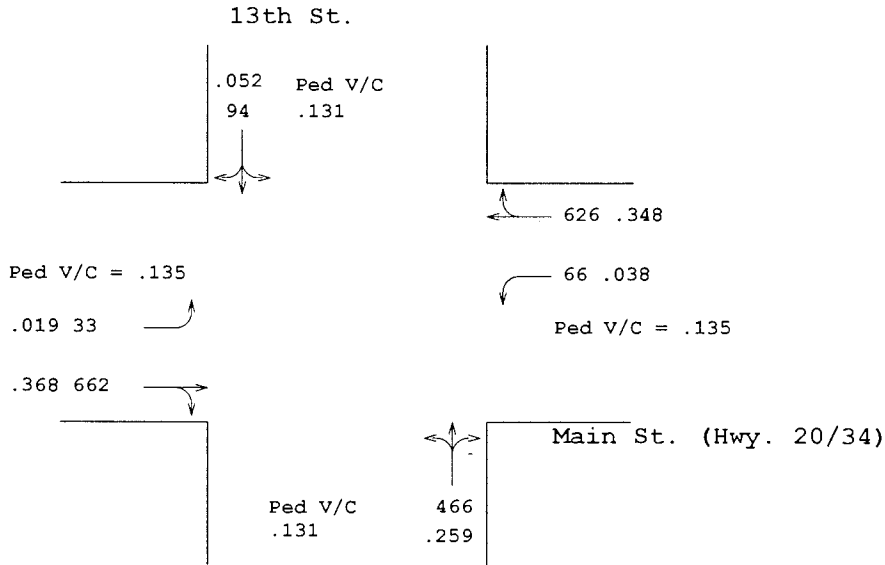

N-S V/C = .272
 E-W V/C = .434
 TOTAL AMBER = .100
 MINIMUM V/C = .067

XXX = Adjusted Volumes .XXX = V/C

APPR	MOVMENT VOLUMES				MOVE SATURATION			MOVEMENT LOS		
	L	T	R	TOT	L	T	R	L	T	R
SOUTH	256	88	122	466	81%	81%	77%	D	D	D
NORTH	23	66	5	94	81%	81%	24%	D	D	A
WEST	33	513	149	695	30%	81%	81%	A	D	D
EAST	66	594	32	692	50%	77%	77%	B	D	D

APPR	TRUCKS %	PED DIST	LANE WIDTH	PHASING
SOUTH	2.0%	50ft	12.ft	N-S -LEFT TURNS NOT PROTECTED
NORTH	2.0%	50ft	12.ft	
WEST	5.0%	48ft	12.ft	E-W -LEFT TURNS PROTECTED WITH OVERLAP
EAST	5.0%	48ft	12.ft	

LEG	LEG VOL AT LOS C	APPR	TIME AVAIL(sec)			RED TIME(sec)			MOVE STORAGE(ft)		
			L	T	R	L	T	R	L	T	R
SOUTH	655	SOUTH	31.2	31.2	31.2	55.8	55.8	55.8	381	381	381
NORTH	217	NORTH	31.2	31.2	31.2	55.8	55.8	55.8	77	77	77
WEST	1360	WEST	7.6	42.2	42.2	79.4	44.8	44.8	38	440	440
EAST	1185	EAST	7.6	42.2	42.2	79.4	44.8	44.8	75	416	416

INTERSECTION = 2 SCENARIO = 2

DATE/TIME: 6/3/98 11:29:57 AM

PROJECT: Philomath TSP
 File: S:\TRANS\PROJECT\ODOT0254\WORKFILE\OPERATIO\SIGOPER.SIG
 CITY: Philomath
 DESCRIPTION: 2015 No Build

ANALYST: BJD
 PEAKFLOW: Pw@e@han 20,000

INTERSECTION LOS = E
 SATURATION = 90%

C= 90 G=81 Y= 9

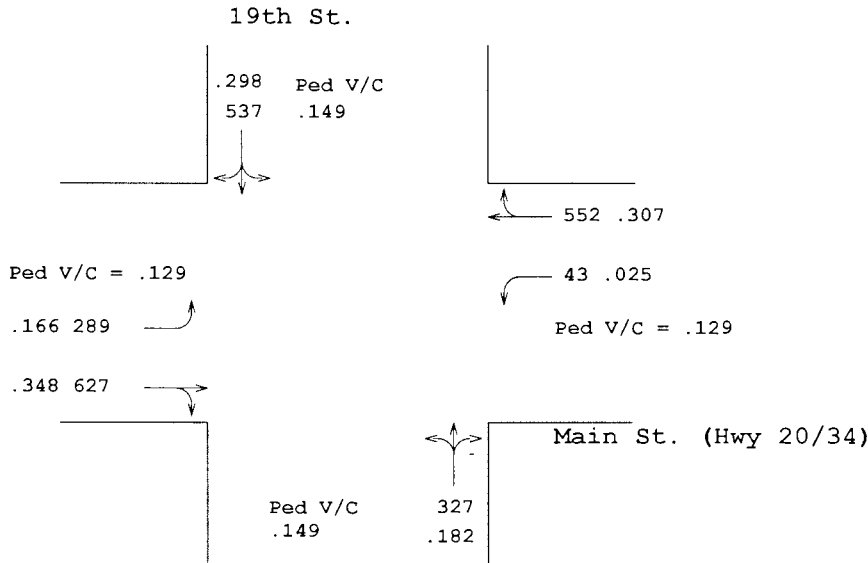

N-S V/C = .332
 E-W V/C = .473
 TOTAL AMBER = .100
 MINIMUM V/C = .067

XXX = Adjusted Volumes .XXX = V/C

APPR	MOVMENT VOLUMES				MOVE SATURATION			MOVEMENT LOS		
	L	T	R	TOT	L	T	R	L	T	R
SOUTH	59	222	46	327	90%	90%	54%	E	E	B
NORTH	46	216	254	516	90%	90%	82%	E	E	D
WEST	265	540	35	840	90%	79%	79%	E	D	D
EAST	40	489	27	556	40%	90%	90%	A	E	E

APPR	TRUCKS %	PED DIST	LANE WIDTH	PHASING
				SOUTH
NORTH	9.0%	40ft	12.ft	E-W -LEFT TURNS PROTECTED WITH OVERLAP
WEST	14.0%	48ft	12.ft	
EAST	12.0%	48ft	12.ft	

LEG	LEG VOL AT LOS C	APPR	TIME AVAIL (sec)			RED TIME (sec)			MOVE STORAGE (ft)		
			L	T	R	L	T	R	L	T	R
SOUTH	476	SOUTH	33.4	33.4	33.4	53.6	53.6	53.6	257	257	257
NORTH	794	NORTH	33.4	33.4	33.4	53.6	53.6	53.6	422	422	422
WEST	1265	WEST	16.7	40.9	40.9	70.3	46.1	46.1	294	428	428
EAST	915	EAST	6.7	30.9	30.9	80.3	56.1	56.1	50	453	453

UNSIGNALIZED - T - INTERSECTION CAPACITY CALCULATION FORM

5/ 5/1998 12:47:27

FILE NAME: hy2034no

CITY: Philomath ANALYST: BJD
 INTERSECTION: Highway 20 at Highway 34
 ALTERNATE: ~~1998 Existing~~ NO BUILD METRO SIZE: LESS THAN 20,000
 COUNT: PM Peak TYPE OF CONTROL: STOP
 LOCATION PLAN:

APPROACH CODES ARE

LANE	1	2	3	4	-----	-----	-----
A	4			A			B
B	2	3			-----		-----
C	1	3			GRADE= .0%		GRADE= .0%
						C	GRADE= .0%

SPEED: 45 MPH
 RESTRICTED SIGHT CODE IS 1
 MINOR STREET ADJUSTMENTS -
 ACCELERATION LANE? NO
 CURB RADIUS OR TURN ANGLE? NO

APPROACH	A		B		C	
MOVE	AT	AR	BL	BT	CL	CR
VOLUME	512	9	368	699	10	219
PCH			405		11	241
LANES	1		2		2	

STEP 1 RIGHT TURN FROM C CR
 CONFLICTING FLOWS = MH = 517. VPH
 CRITICAL GAP = TG = 6.0 SECS
 POTENTIAL CAPACITY = M1 = 525. PCH
 SHARED LANE - SEE STEP 3
 NO SHARED LANE DEMAND = 241 PCH
 AVAILABLE RESERVE = 284. PCH
 DELAY & LOS = C

STEP 2 LEFT TURN FROM B BL
 CONFLICTING FLOWS = MH = 521. VPH
 CRITICAL GAP = TG = 5.5 SECS
 POTENTIAL CAPACITY = M2 = 601. PCH
 DEMAND = BL = 405 PCH
 CAPACITY USED = 67.34 %
 IMPEDANCE FACTOR = P2 = .409
 AVAILABLE RESERVE = 196. PCH
 DELAY & LOS = D

STEP 3 LEFT TURN FROM C CL
 CONFLICTING FLOWS = MH = 1584. VPH
 CRITICAL GAP = TG = 6.5 SECS
 POTENTIAL CAPACITY = M3 = 80. PCH
 ADJUSTING FOR IMPEDANCE = M3 = 33. PCH

STEP 3 CONTINUED

CL

NO SHARED LANE DEMAND = 11 PCH
AVAILABLE RESERVE = 22. PCH
DELAY & LOS = E

SHARED LANE DEMAND = 0 PCH
POTENTIAL CAPACITY = M13 = 0. PCH
AVAILABLE RESERVE = 0. PCH
DELAY & LOS = N/A

LOS C VOLUMES:
VEHICLES PER HOUR

LEG C
320.

VER 03/93

UNSIGNALIZED INTERSECTION CAPACITY CALCULATION FORM

4-WAY INTERSECTION

5/13/1998 16:32:25

FILE NAME: main9no

CITY: Philomath
 INTERSECTION: Main St. at 9th St.
 ALTERNATE: 2015- No Build
 COUNT: PM Peak
 LOCATION PLAN:

ANALYST: bjd
 METRO SIZE: LESS THAN 20,000
 TYPE OF CONTROL: STOP

APPROACH CODES ARE

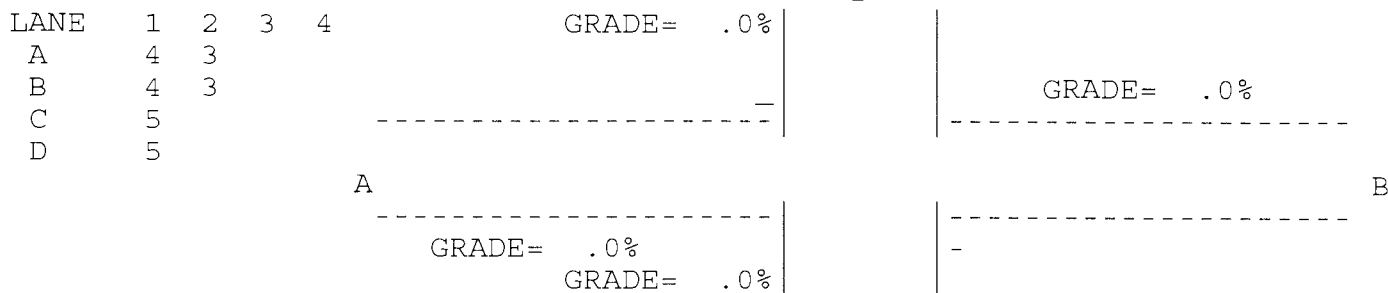

SPEED: 30 MPH
 RESTRICTED SIGHT CODE IS 1
 MINOR STREET ADJUSTMENTS -
 ACCELERATION LANE? NO
 CURB RADIUS OR TURN ANGLE? NO

APPR	A			B			C			D		
MOVE	AL	AT	AR	BL	BT	BR	CL	CT	CR	DL	DT	DR
VOL	216	650	5	5	864	63	5	5	5	92	5	520
PCH	238			6			6	6	6	101	6	572
LANES		2			2			1			1	

STEP 1 RIGHT TURN FROM C/D

CONFLICTING FLOWS = MH =	CR	DR
CRITICAL GAP = TG =	653.	896. VPH
POTENTIAL CAPACITY = M1 =	5.5	5.5 SECS
DEMAND =	512.	378. PCH
CAPACITY USED =	6	572 PCH
IMPEDANCE FACTOR =	1.173	***** %
	.993	-.737

SHARED LANE - SEE STEP 3

NO SHARED LANE - RESERVE =	0.	0. PCH
DELAY & LOS =	N/A	N/A

STEP 2 - LEFT TURNS FROM B/A

CONFLICTING FLOWS = MH =	BL	AL
CRITICAL GAP = TG =	655.	927. VPH
POTENTIAL CAPACITY = M2 =	5.0	5.0 SECS
DEMAND =	598.	435. PCH
CAPACITY USED =	6	238 PCH
IMPEDANCE FACTOR =	1.00	54.69 %
AVAILABLE RESERVE =	.994	.542
DELAY & LOS =	592.	197. PCH
	A	D

STEP 3	THRU MOVEMENT FROM C/D	CT	DT
	CONFLICTING FLOWS = MT =	1801.	1772. VPH
	CRITICAL GAP = TG =	6.0	6.0 SECS
	POTENTIAL CAPACITY = MN3 =	76.	81. PCH
	IMPEDANCE ADJUSTMENT = M3 =	41.	43. PCH
	DEMAND =	6	6 PCH
	CAPACITY USED =	7.87	7.45 %
	IMPEDANCE FACTOR = P3 =	.946	.949

NO SHARED LANE		
AVAILABLE RESERVE =	0.	0. PCH
DELAY & LOS =	N/A	N/A

SHARED LANE WITH LEFT TURN - SEE STEP 4

SHARED LANE DEMAND =	0	0 PCH
POTENTIAL CAPACITY = M13 =	0.	0. PCH
AVAILABLE RESERVE =	0.	0. PCH
DELAY & LOS =	N/A	N/A

STEP 4 - LEFT TURN FROM C/D	CL	DL
CONFLICTING FLOWS = MH =	2326.	1782. VPH
CRITICAL GAP = TG =	6.0	6.0 SECS
POTENTIAL CAPACITY = MN =	-6.	79. PCH
ADJUST FOR IMPEDANCE:	2.	40. PCH

NO SHARED LANE DEMAND =	0	0 PCH
AVAILABLE RESERVE =	0.	0. PCH
DELAY & LOS =	N/A	N/A

WITH LEFT & THRU		
SHARED LANE DEMAND =	0	0 PCH
CAPACITY OF SHARED LANE =	0.	0. PCH
AVAILABLE RESERVE =	0.	0. PCH
DELAY & LOS =	N/A	N/A

WITH LEFT, THRU, & RIGHT		
SHARED LANE DEMAND =	18	679 PCH
CAPACITY OF SHARED LANE =	6.	163. PCH
AVAILABLE RESERVE =	-12.	-516. PCH
DELAY & LOS =	F	F

LOS C VOLUMES:
VEHICLES PER HOUR

FOR LEG C
16.

FOR LEG D
15.

UNSIGNALIZED - T - INTERSECTION CAPACITY CALCULATION FORM

5/13/1998 13: 5:59

FILE NAME: main26no

CITY: Philomath
 INTERSECTION: Main St. at 26th St.
 ALTERNATE: ~~Existing Cond.~~ **NO BUILD**
 COUNT: PM Peak
 LOCATION PLAN:

ANALYST: BJD
 METRO SIZE: LESS THAN 20,000
 TYPE OF CONTROL: STOP

APPROACH CODES ARE

LANE	1	2	3	4	-----	
A	4			A		B
B	6					
C	7					
				GRADE= .0%		GRADE= .0%
						GRADE= .0%

SPEED: 40 MPH
 RESTRICTED SIGHT CODE IS 1
 MINOR STREET ADJUSTMENTS -
 ACCELERATION LANE? NO
 CURB RADIUS OR TURN ANGLE? NO

APPROACH	A		B		C	
MOVE	AT	AR	BL	BT	CL	CR
VOLUME	565	35	43	710	28	36
PCH			47		31	40
LANES	1		1		1	

STEP 1 RIGHT TURN FROM C CR
 CONFLICTING FLOWS = MH = 583. VPH
 CRITICAL GAP = TG = 6.0 SECS
 POTENTIAL CAPACITY = M1 = 480. PCH

 SHARED LANE - SEE STEP 3

 NO SHARED LANE DEMAND = 0 PCH
 AVAILABLE RESERVE = 0. PCH
 DELAY & LOS = N/A

STEP 2 LEFT TURN FROM B BL
 CONFLICTING FLOWS = MH = 600. VPH
 CRITICAL GAP = TG = 5.5 SECS
 POTENTIAL CAPACITY = M2 = 546. PCH
 DEMAND = BL = 47 PCH
 CAPACITY USED = 8.61 %
 IMPEDANCE FACTOR = P2 = .941
 AVAILABLE RESERVE = 499. PCH
 DELAY & LOS = A

STEP 3 LEFT TURN FROM C CL
 CONFLICTING FLOWS = MH = 1336. VPH
 CRITICAL GAP = TG = 6.5 SECS
 POTENTIAL CAPACITY = M3 = 125. PCH
 ADJUSTING FOR IMPEDANCE = M3 = 118. PCH

STEP 3 CONTINUED

CL

NO SHARED LANE DEMAND =	0	PCH
AVAILABLE RESERVE =	0.	PCH
DELAY & LOS =	N/A	
SHARED LANE DEMAND =	71	PCH
POTENTIAL CAPACITY = M13 =	205.	PCH
AVAILABLE RESERVE =	134.	PCH
DELAY & LOS =	D	

LOS C VOLUMES:
VEHICLES PER HOUR

LEG C
117.

VER 03/93

**INTERSECTION 8
SCENARIO 1
MAY 19, 1998**

INTERSECTION = 8 SCENARIO = 1 DATE/TIME: 5/19/98 3:46:47 PM

PROJECT: Philomath TSP ANALYST: BJD
 File: S:\TRANS\PROJECT\ODOT0254\WORKFILE\OPERATIO\SIGOPER2.SIG
 CITY: Philomath PEAK HOUR: PM Peak Than 20,000
 DESCRIPTION: 2015- TSM Improvement - Traffic Signal

INTERSECTION LOS = C-D
 SATURATION = 72%

C= 90 G=81 Y= 9

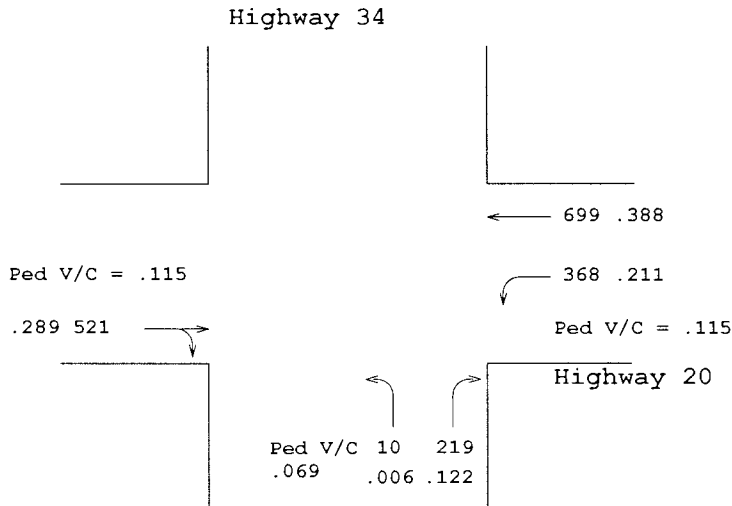

N-S V/C = .122
 E-W V/C = .501
 TOTAL AMBER = .100
 MINIMUM V/C = .067

XXX = Adjusted Volumes .XXX = V/C

APPR	MOVMENT VOLUMES				MOVE SATURATION			MOVEMENT LOS		
	L	T	R	TOT	L	T	R	L	T	R
SOUTH	10	0	219	229	48%	0%	72%	A	...	C-D
NORTH	0	0	0	0	0%	0%	0%
WEST	0	512	9	521	0%	72%	72%	...	C-D	C-D
EAST	368	699	0	1067	72%	58%	0%	C-D	B	...

APPR	TRUCKS %	PED DIST	LANE WIDTH	PHASING
SOUTH	5.0%	48ft	12.ft	N-S -LEFT TURNS NOT PROTECTED
NORTH	5.0%	48ft	12.ft	
WEST	5.0%	24ft	12.ft	E-W -LEFT TURNS PROTECTED WITH OVERLAP
EAST	5.0%	24ft	12.ft	

LEG	LEG VOL AT LOS C	APPR	TIME AVAIL(sec)			RED TIME(sec)			MOVE STORAGE(ft)		
			L	T	R	L	T	R	L	T	R
SOUTH	603	SOUTH	15.8	0.0	15.8	71.2	0.0	71.2	10	0	226
NORTH	0	NORTH	0.0	0.0	0.0	0.0	0.0	0.0	0	0	0
WEST	1225	WEST	0.0	37.7	37.7	0.0	49.3	49.3	0	379	379
EAST	1790	EAST	27.5	65.2	0.0	59.5	21.8	0.0	319	241	0

INTERSECTION = 1 SCENARIO = 1

DATE/TIME: 5/13/98 4:26:42 PM

PROJECT: Philomath TSP
 File: C:\SIGCAP2\SIGOPER2.SIG
 CITY: Philomath
 DESCRIPTION: 2015- TSM Improvement- Traffic Signal at 9th St.

ANALYST: BJD
 PEAK HOUR: PM Peak
 POPULATION: Fewer Than 20,000

INTERSECTION LOS = E
 SATURATION = 91%

C= 90 G=81 Y= 9

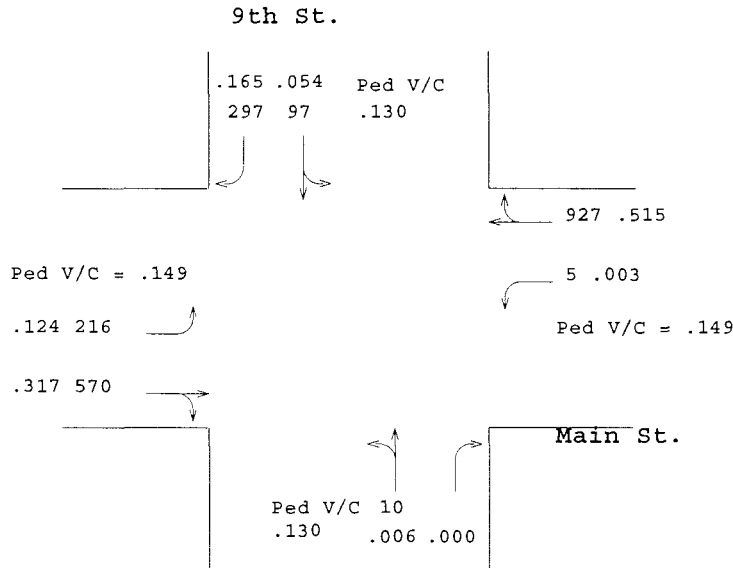

N-S V/C = .168
 E-W V/C = .639
 TOTAL AMBER = .100
 MINIMUM V/C = .067

XXX = Adjusted Volumes .XXX = V/C

APPR	MOVMENT VOLUMES				MOVE SATURATION			MOVEMENT LOS		
	L	T	R	TOT	L	T	R	L	T	R
SOUTH	5	5	5	15	91%	91%	0%	E	E	A
NORTH	92	5	520	617	91%	91%	56%	E	E	B
WEST	216	565	5	786	91%	55%	55%	E	B	B
EAST	5	864	63	932	13%	91%	91%	A	E	E

APPR	TRUCKS %	PED DIST	LANE WIDTH	PHASING
NORTH	5.0%	48ft	12.ft	N-S - Right Turn Overlap
WEST	5.0%	40ft	12.ft	E-W -LEFT TURNS PROTECTED WITH OVERLAP
EAST	5.0%	40ft	12.ft	

LEG	LEG VOL AT LOS C	APPR	TIME AVAIL(sec)			RED TIME(sec)			MOVE STORAGE(ft)		
			L	T	R	L	T	R	L	T	R
SOUTH	23	SOUTH	16.8	16.8	23.5	70.2	70.2	63.5	10	10	5
NORTH	692	NORTH	16.8	16.8	29.3	70.2	70.2	57.7	99	99	438
WEST	1671	WEST	12.5	57.5	57.5	74.5	29.5	29.5	233	258	258
EAST	1225	EAST	6.7	51.7	51.7	80.3	35.3	35.3	6	493	493

INTERSECTION = 2 SCENARIO = 1

DATE/TIME: 5/13/98 4:27:03 PM

PROJECT: Philomath TSP
 File: C:\SIGCAP2\SIGOPER2.SIG
 CITY: Philomath
 DESCRIPTION: 2015- TSM Improvements- Traffic Signal at 26th St.

ANALYST: BJD
 PEAK HOUR: PM Peak
 POPULATION: Fewer Than 20,000

INTERSECTION LOS = B
 SATURATION = 56%

C= 90 G=81 Y= 9

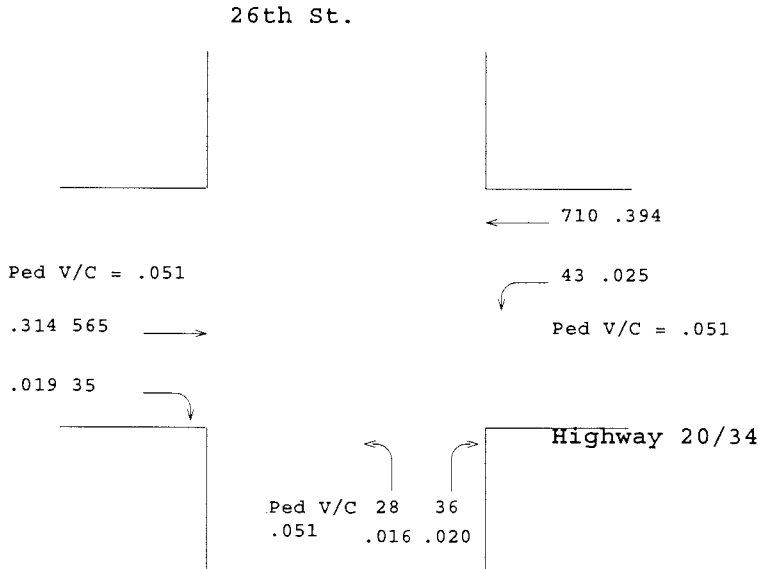

N-S V/C = .067
 E-W V/C = .394
 TOTAL AMBER = .100
 MINIMUM V/C = .067

XXX = Adjusted Volumes .XXX = V/C

APPR	MOVMENT VOLUMES				MOVE SATURATION			MOVEMENT LOS		
	L	T	R	TOT	L	T	R	L	T	R
SOUTH	28	0	36	64	56%	0%	24%	B	...	A
NORTH	0	0	0	0	0%	0%	0%
WEST	0	565	35	600	0%	54%	13%	...	B	A
EAST	43	710	0	753	27%	56%	0%	A	B	...

APPR	TRUCKS %	PED DIST	LANE WIDTH	PHASING	
SOUTH	5.0%	24ft	12.ft	N-S -LEFT TURNS NOT PROTECTED	
NORTH	5.0%	24ft	12.ft		
WEST	5.0%	24ft	12.ft	E-W -LEFT TURNS PROTECTED WITH OVERLAP	
EAST	5.0%	24ft	12.ft		

LEG	LEG VOL AT LOS C	TIME AVAIL(sec)			RED TIME(sec)			MOVE STORAGE(ft)			
		APPR	L	T	R	L	T	R	L	T	R
SOUTH	191	SOUTH	11.7	0.0	11.7	75.3	0.0	75.3	30	0	39
NORTH	0	NORTH	0.0	0.0	0.0	0.0	0.0	0.0	0	0	0
WEST	1799	WEST	0.0	57.6	57.6	0.0	29.4	29.4	0	254	16
EAST	1821	EAST	11.7	69.3	0.0	75.3	17.7	0.0	47	204	0

UNSIGNALIZED INTERSECTION CAPACITY CALCULATION FORM
4-WAY INTERSECTION

5/15/1998 10:30: 5

FILE NAME: main9wh

CITY: Philomath
INTERSECTION: Main St. at 9th St.
ALTERNATE: 2015-West Hills Rd E
COUNT: PM Peak
LOCATION PLAN:

ANALYST: bjd
METRO SIZE: LESS THAN 20,000
TYPE OF CONTROL: STOP

APPROACH CODES ARE

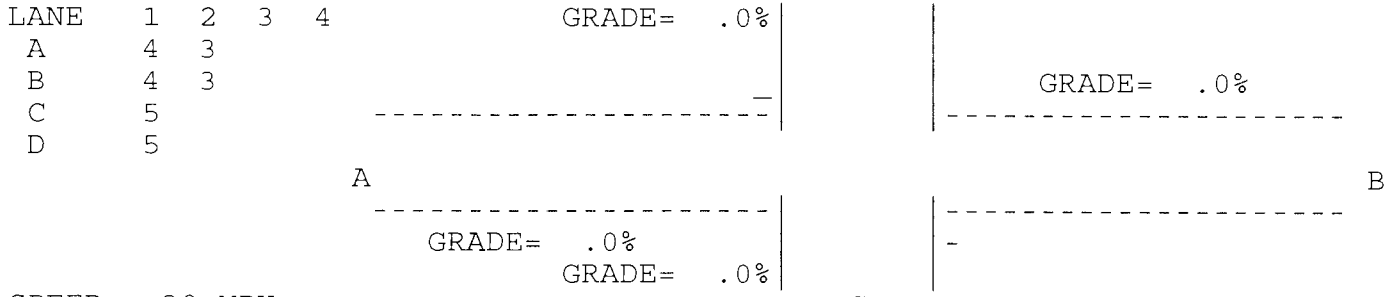

SPEED: 30 MPH
RESTRICTED SIGHT CODE IS 1
MINOR STREET ADJUSTMENTS -
ACCELERATION LANE? NO
CURB RADIUS OR TURN ANGLE? NO

APPR	A			B			C			D		
MOVE	AL	AT	AR	BL	BT	BR	CL	CT	CR	DL	DT	DR
VOL	17	459	5	5	646	107	5	5	5	125	5	38
PCH	19			6			6	6	6	138	6	42
LANES			2			2			1			1

STEP 1 RIGHT TURN FROM C/D

CONFLICTING FLOWS = MH =	462.	700. VPH
CRITICAL GAP = TG =	5.5	5.5 SECS
POTENTIAL CAPACITY = M1 =	646.	483. PCH
DEMAND =	6	42 PCH
CAPACITY USED =	.928	8.702 %
IMPEDANCE FACTOR =	.995	.941

SHARED LANE - SEE STEP 3

NO SHARED LANE - RESERVE =	0.	0. PCH
DELAY & LOS =	N/A	N/A

STEP 2 - LEFT TURNS FROM B/A

CONFLICTING FLOWS = MH =	464.	753. VPH
CRITICAL GAP = TG =	5.0	5.0 SECS
POTENTIAL CAPACITY = M2 =	740.	534. PCH
DEMAND =	6	19 PCH
CAPACITY USED =	.81	3.55 %
IMPEDANCE FACTOR =	.995	.977
AVAILABLE RESERVE =	734.	515. PCH
DELAY & LOS =	A	A

STEP 3	THRU MOVEMENT FROM C/D	CT	DT
	CONFLICTING FLOWS = MT =	1237.	1186. VPH
	CRITICAL GAP = TG =	6.0	6.0 SECS
	POTENTIAL CAPACITY = MN3 =	188.	202. PCH
	IMPEDANCE ADJUSTMENT = M3 =	183.	197. PCH
	DEMAND =	6	6 PCH
	CAPACITY USED =	3.20	2.96 %
	IMPEDANCE FACTOR = P3 =	.979	.981

NO SHARED LANE		
AVAILABLE RESERVE=	0.	0. PCH
DELAY & LOS =	N/A	N/A

SHARED LANE WITH LEFT TURN - SEE STEP 4

SHARED LANE DEMAND =	0	0 PCH
POTENTIAL CAPACITY = M13 =	0.	0. PCH
AVAILABLE RESERVE =	0.	0. PCH
DELAY & LOS =	N/A	N/A

STEP 4 -	LEFT TURN FROM C/D	CL	DL
	CONFLICTING FLOWS = MH =	1280.	1196. VPH
	CRITICAL GAP = TG =	6.0	6.0 SECS
	POTENTIAL CAPACITY = MN =	176.	199. PCH
	ADJUST FOR IMPEDANCE:	158.	189. PCH

NO SHARED LANE DEMAND =	0	0 PCH
AVAILABLE RESERVE =	0.	0. PCH
DELAY & LOS =	N/A	N/A

WITH LEFT & THRU		
SHARED LANE DEMAND =	0	0 PCH
CAPACITY OF SHARED LANE =	0.	0. PCH
AVAILABLE RESERVE =	0.	0. PCH
DELAY & LOS =	N/A	N/A

WITH LEFT, THRU, & RIGHT		
SHARED LANE DEMAND =	18	186 PCH
CAPACITY OF SHARED LANE =	225.	219. PCH
AVAILABLE RESERVE =	207.	33. PCH
DELAY & LOS =	C	E

LOS C VOLUMES:	FOR LEG C	FOR LEG D
VEHICLES PER HOUR	30.	23.

UNSIGNALIZED INTERSECTION CAPACITY CALCULATION FORM
4-WAY INTERSECTION

5/15/1998 10:37:31

FILE NAME: main9cp

CITY: Philomath
INTERSECTION: Main St. at 9th St.
ALTERNATE: 2015-Couplet Alt. 1
COUNT: PM Peak
LOCATION PLAN:

ANALYST: bjd
METRO SIZE: LESS THAN 20,000
TYPE OF CONTROL: STOP

APPROACH CODES ARE

LANE 1 2 3 4
A 0
B 4 6
C 6
D 4

GRADE= .0%

D

GRADE= .0%

A

GRADE= .0%

GRADE= .0%

C

B

SPEED: 30 MPH

RESTRICTED SIGHT CODE IS 1

MINOR STREET ADJUSTMENTS -

ACCELERATION LANE? NO

CURB RADIUS OR TURN ANGLE? NO

APPR	A			B			C			D		
MOVE	AL	AT	AR	BL	BT	BR	CL	CT	CR	DL	DT	DR
VOL	0	0	0	50	1230	70	5	30	0	0	50	163
PCH	0			55			6	33	0	0	55	179
LANES		0			2			1			1	

STEP 1 RIGHT TURN FROM C/D

CONFLICTING FLOWS = MH =	CR	DR
CRITICAL GAP = TG =	0.	650. VPH
POTENTIAL CAPACITY = M1 =	5.5	5.5 SECS
DEMAND =	1105.	513. PCH
CAPACITY USED =	0	179 PCH
IMPEDANCE FACTOR =	.000	34.876 %
	1.001	.730

SHARED LANE - SEE STEP 3

NO SHARED LANE - RESERVE =	0.	0. PCH
DELAY & LOS =	N/A	N/A

STEP 2 - LEFT TURNS FROM B/A

CONFLICTING FLOWS = MH =	BL	AL
CRITICAL GAP = TG =	0.	0. VPH
POTENTIAL CAPACITY = M2 =	5.0	5.0 SECS
DEMAND =	1202.	272. PCH
CAPACITY USED =	55	0 PCH
IMPEDANCE FACTOR =	4.57	.00 %
AVAILABLE RESERVE =	.970	1.001
DELAY & LOS =	1147.	0. PCH
	A	N/A

STEP 3	THRU MOVEMENT FROM C/D	CT	DT
	CONFLICTING FLOWS = MT =	1350.	1315. VPH
	CRITICAL GAP = TG =	6.0	6.0 SECS
	POTENTIAL CAPACITY = MN3 =	159.	167. PCH
	IMPEDANCE ADJUSTMENT = M3 =	154.	162. PCH
	DEMAND =	33	55 PCH
	CAPACITY USED =	20.81	32.92 %
	IMPEDANCE FACTOR = P3 =	.849	.748

NO SHARED LANE		
AVAILABLE RESERVE=	0.	0. PCH
DELAY & LOS =	N/A	N/A

SHARED LANE WITH LEFT TURN - SEE STEP 4

SHARED LANE DEMAND =	0	234 PCH
POTENTIAL CAPACITY = M13 =	0.	340. PCH
AVAILABLE RESERVE =	0.	106. PCH
DELAY & LOS =	N/A	D

STEP 4 - LEFT TURN FROM C/D	CL	DL
CONFLICTING FLOWS = MH =	1563.	1345. VPH
CRITICAL GAP = TG =	6.0	6.0 SECS
POTENTIAL CAPACITY = MN =	115.	160. PCH
ADJUST FOR IMPEDANCE:	61.	132. PCH

NO SHARED LANE DEMAND =	0	0 PCH
AVAILABLE RESERVE =	0.	0. PCH
DELAY & LOS =	N/A	N/A

WITH LEFT & THRU		
SHARED LANE DEMAND =	39	0 PCH
CAPACITY OF SHARED LANE =	124.	0. PCH
AVAILABLE RESERVE =	85.	0. PCH
DELAY & LOS =	E	N/A

WITH LEFT, THRU, & RIGHT		
SHARED LANE DEMAND =	0	0 PCH
CAPACITY OF SHARED LANE =	0.	0. PCH
AVAILABLE RESERVE =	0.	0. PCH
DELAY & LOS =	N/A	N/A

LOS C VOLUMES:	FOR LEG C	FOR LEG D
VEHICLES PER HOUR	102.	118.

**INTERSECTION 1
SCENARIO 2
MAY 18, 1998**

INTERSECTION = 1 SCENARIO = 2

DATE/TIME: 5/18/98 4:10:59 PM

PROJECT: Philomath TSP
 File: C:\SIGCAP2\SIGOPER2.SIG
 CITY: Philomath
 DESCRIPTION: 2015- Couplet Alt. 1a

ANALYST: BJD
 PEAK HOUR: PM Peak
 POPULATION: Fewer Than 20,000

INTERSECTION LOS = B
 SATURATION = 51%

C= 90 G=84 Y= 6

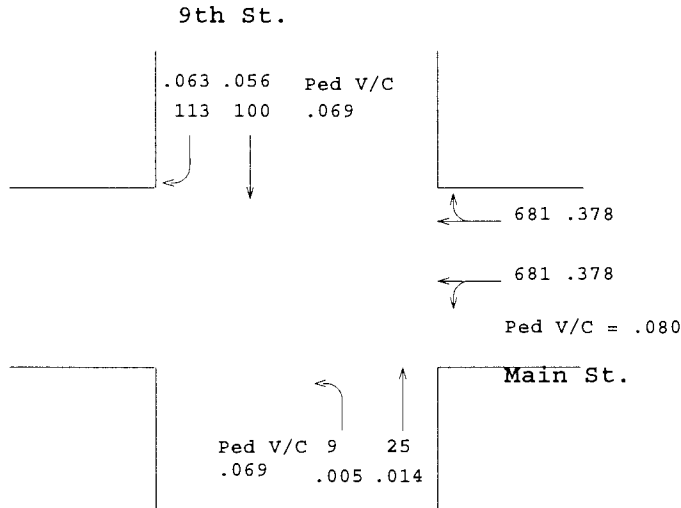

N-S V/C = .069
 E-W V/C = .378
 TOTAL AMBER = .067
 MINIMUM V/C = .067

XXX = Adjusted Volumes .XXX = V/C

APPR	MOVMENT VOLUMES				MOVE SATURATION			MOVEMENT LOS		
	L	T	R	TOT	L	T	R	L	T	R
SOUTH	9	25	0	34	51%	16%	0%	B	A	...
NORTH	0	100	113	213	0%	43%	47%	...	A	A
WEST	0	0	0	0	0%	0%	0%
EAST	5	1279	78	1362	51%	51%	51%	B	B	B

APPR	TRUCKS %	PED DIST	LANE WIDTH	PHASING
SOUTH	5.0%	48ft	12.ft	N-S -LEFT TURNS NOT PROTECTED
NORTH	5.0%	48ft	12.ft	N-S - Right Turn Overlap
WEST	5.0%	40ft	12.ft	E-W -LEFT TURNS NOT PROTECTED
EAST	5.0%	40ft	12.ft	

LEG	LEG VOL AT LOS C	APPR	TIME AVAIL(sec)			RED TIME(sec)			MOVE STORAGE(ft)		
			L	T	R	L	T	R	L	T	R
SOUTH	203	SOUTH	13.0	13.0	0.0	74.0	74.0	0.0	10	27	0
NORTH	461	NORTH	0.0	13.0	13.0	0.0	74.0	74.0	0	107	121
WEST	2046	WEST	0.0	0.0	0.0	0.0	0.0	0.0	0	0	0
EAST	1989	EAST	71.0	71.0	71.0	16.0	16.0	16.0	179	179	179

INTERSECTION = 3 SCENARIO = 1

DATE/TIME: 5/18/98 4:14:14 PM

PROJECT: Philomath TSP
 File: C:\SIGCAP2\SIGOPER2.SIG
 CITY: Philomath
 DESCRIPTION: 2015- Couplet Alt. 1a

ANALYST: BJD
 PEAK HOUR: PM Peak
 POPULATION: Fewer Than 20,000

INTERSECTION LOS = A
 SATURATION = 37%

C= 90 G=84 Y= 6

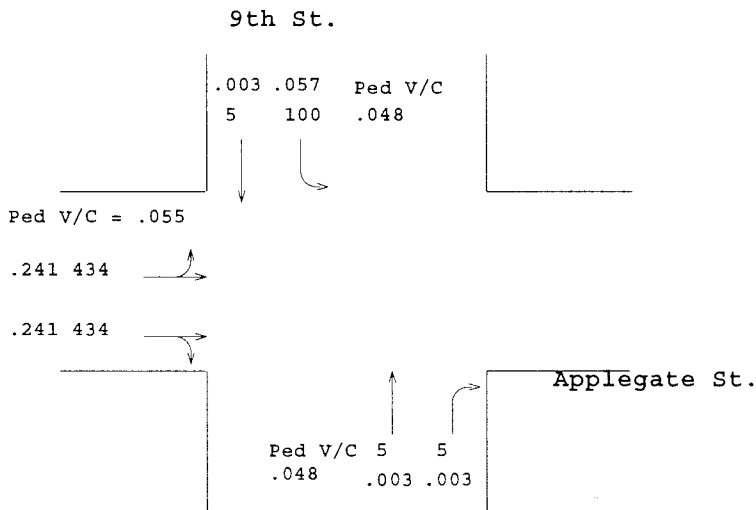

N-S V/C = .067
 E-W V/C = .241
 TOTAL AMBER = .067
 MINIMUM V/C = .067

XXX = Adjusted Volumes .XXX = V/C

APPR	MOVMENT VOLUMES				MOVE SATURATION			MOVEMENT LOS		
	L	T	R	TOT	L	T	R	L	T	R
SOUTH	0	5	5	10	0%	8%	8%	...	A	A
NORTH	100	5	0	105	37%	8%	0%	A	A	...
WEST	34	829	5	868	37%	37%	37%	A	A	A
EAST	0	0	0	0	0%	0%	0%

APPR	TRUCKS %	PED DIST	LANE WIDTH	PHASING
				N-S -LEFT TURNS NOT PROTECTED
WEST	5.0%	40ft	12.ft	E-W -LEFT TURNS NOT PROTECTED
EAST	5.0%	40ft	12.ft	

LEG	LEG VOL AT LOS C	APPR	TIME AVAIL(sec)			RED TIME(sec)			MOVE STORAGE(ft)		
			L	T	R	L	T	R	L	T	R
SOUTH	42	SOUTH	0.0	18.2	18.2	0.0	68.8	68.8	0	5	5
NORTH	306	NORTH	18.2	18.2	0.0	68.8	68.8	0.0	100	5	0
WEST	1843	WEST	65.8	65.8	65.8	21.2	21.2	21.2	146	146	146
EAST	1983	EAST	0.0	0.0	0.0	0.0	0.0	0.0	0	0	0

INTERSECTION = 4 SCENARIO = 1

DATE/TIME: 5/18/98 4:17:55 PM

PROJECT: Philomath TSP
 File: C:\SIGCAP2\SIGOPER2.SIG
 CITY: Philomath
 DESCRIPTION: 2015- Couplet Alt. 1a

ANALYST: BJD
 PEAK HOUR: PM Peak
 POPULATION: Fewer Than 20,000

INTERSECTION LOS = B
 SATURATION = 53%

C= 90 G=84 Y= 6

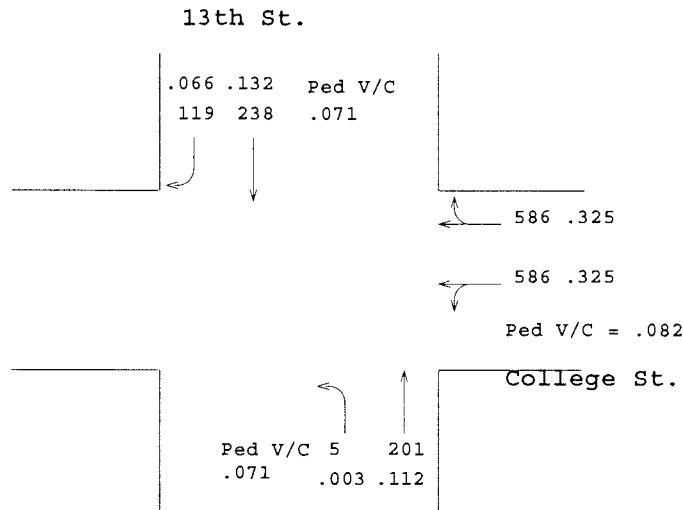

N-S V/C = .135
 E-W V/C = .325
 TOTAL AMBER = .067
 MINIMUM V/C = .067

XXX = Adjusted Volumes .XXX = V/C

APPR	MOVMENT VOLUMES				MOVE SATURATION			MOVEMENT LOS		
	L	T	R	TOT	L	T	R	L	T	R
SOUTH	5	201	0	206	53%	45%	0%	B	A	...
NORTH	0	238	119	357	0%	52%	29%	...	B	A
WEST	0	0	0	0	0%	0%	0%
EAST	9	951	211	1171	53%	53%	53%	B	B	B

APPR	TRUCKS %	PED DIST	LANE WIDTH	PHASING
				N-S -LEFT TURNS NOT PROTECTED
EAST	5.0%	40ft	12.ft	E-W -LEFT TURNS NOT PROTECTED

LEG	LEG VOL AT LOS C	APPR	TIME AVAIL(sec)			RED TIME(sec)			MOVE STORAGE(ft)		
			L	T	R	L	T	R	L	T	R
SOUTH	643	SOUTH	24.6	24.6	0.0	62.4	62.4	0.0	5	182	0
NORTH	1091	NORTH	0.0	24.6	24.6	0.0	62.4	62.4	0	216	108
WEST	1526	WEST	0.0	0.0	0.0	0.0	0.0	0.0	0	0	0
EAST	1662	EAST	59.4	59.4	59.4	27.6	27.6	27.6	249	249	249

INTERSECTION = 6 SCENARIO = 1

DATE/TIME: 5/18/98 4:28:58 PM

PROJECT: Philomath TSP
 File: C:\SIGCAP2\SIGOPER2.SIG
 CITY: Philomath
 DESCRIPTION: 2015- Couplet Alt. 1a

ANALYST: BJD
 PEAK HOUR: PM Peak
 POPULATION: Fewer Than 20,000

INTERSECTION LOS = A
 SATURATION = 48%

C= 90 G=84 Y= 6

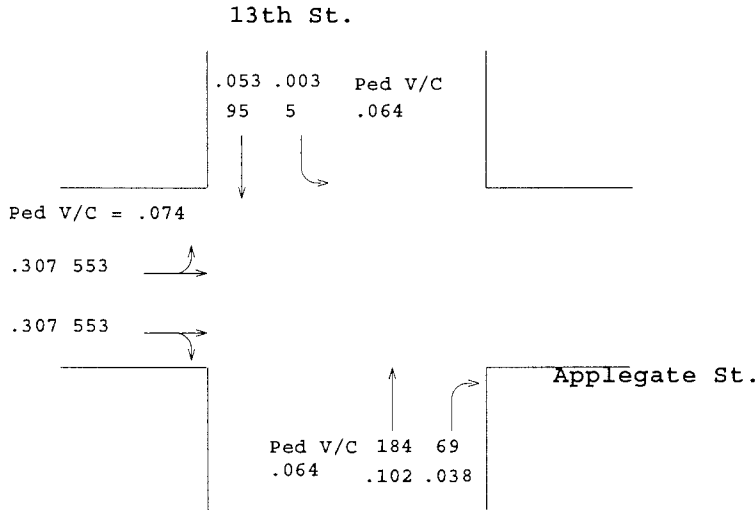

N-S V/C = .105
 E-W V/C = .307
 TOTAL AMBER = .067
 MINIMUM V/C = .067

XXX = Adjusted Volumes .XXX = V/C

APPR	MOVMENT VOLUMES				MOVE SATURATION			MOVEMENT LOS		
	L	T	R	TOT	L	T	R	L	T	R
SOUTH	0	184	69	253	0%	47%	22%	...	A	A
NORTH	5	95	0	100	48%	27%	0%	A	A	...
WEST	112	934	60	1106	48%	48%	48%	A	A	A
EAST	0	0	0	0	0%	0%	0%

APPR	TRUCKS %	PED DIST	LANE WIDTH	PHASING
SOUTH	5.0%	48ft	12.ft	N-S -LEFT TURNS NOT PROTECTED
NORTH	5.0%	48ft	12.ft	
WEST	5.0%	40ft	12.ft	E-W -LEFT TURNS NOT PROTECTED
EAST	5.0%	40ft	12.ft	

LEG	LEG VOL AT LOS C	TIME AVAIL(sec)			RED TIME(sec)			MOVE STORAGE(ft)			
		APPR	L	T	R	L	T	R	L	T	R
SOUTH	646	SOUTH	0.0	21.4	21.4	0.0	65.6	65.6	0	175	66
NORTH	627	NORTH	21.4	21.4	0.0	65.6	65.6	0.0	5	90	0
WEST	1752	WEST	62.6	62.6	62.6	24.4	24.4	24.4	211	211	211
EAST	1597	EAST	0.0	0.0	0.0	0.0	0.0	0.0	0	0	0

INTERSECTION = 7 SCENARIO = 1 DATE/TIME: 5/19/98 2:13:37 PM

PROJECT: Philomath TSP ANALYST: BJD
 File: S:\TRANS\PROJECT\ODOT0254\WORKFILE\OPERATIO\SIGOPER2.SIG
 CITY: Philomath PEAKFLOWRN: PMwPeakRhan 20,000
 DESCRIPTION: 2015- Couplet Alt. 1a

INTERSECTION LOS = B
 SATURATION = 52%

C= 90 G=84 Y= 6

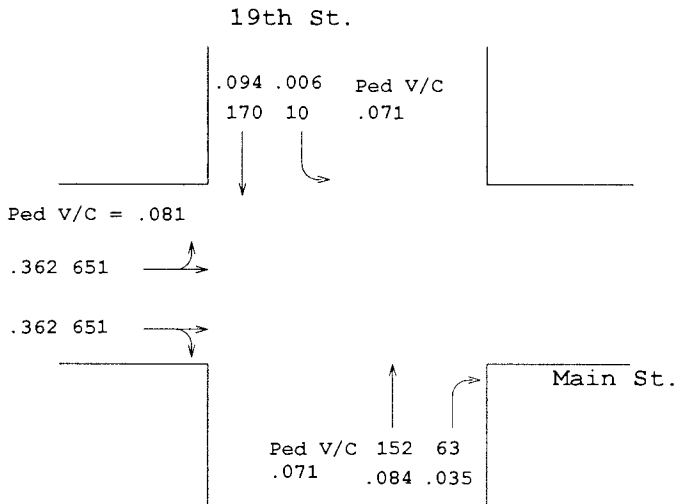

N-S V/C = .094
 E-W V/C = .362
 TOTAL AMBER = .067
 MINIMUM V/C = .067

XXX = Adjusted Volumes .XXX = V/C

APPR	MOVMENT VOLUMES				MOVE SATURATION			MOVEMENT LOS		
	L	T	R	TOT	L	T	R	L	T	R
SOUTH	0	152	63	215	0%	47%	24%	...	A	A
NORTH	10	170	0	180	50%	52%	0%	B	B	...
WEST	505	684	113	1302	52%	52%	52%	B	B	B
EAST	0	0	0	0	0%	0%	0%

APPR	TRUCKS %	PED DIST	LANE WIDTH	PHASING
SOUTH	5.0%	48ft	12.ft	N-S -LEFT TURNS NOT PROTECTED
NORTH	5.0%	48ft	12.ft	
WEST	5.0%	40ft	12.ft	E-W -LEFT TURNS NOT PROTECTED
EAST	5.0%	40ft	12.ft	

LEG	LEG VOL AT LOS C	APPR	TIME AVAIL (sec)			RED TIME (sec)			MOVE STORAGE (ft)		
			L	T	R	L	T	R	L	T	R
SOUTH	713	SOUTH	0.0	17.4	17.4	0.0	69.6	69.6	0	153	64
NORTH	1199	NORTH	17.4	17.4	0.0	69.6	69.6	0.0	10	171	0
WEST	1865	WEST	66.6	66.6	66.6	20.4	20.4	20.4	212	212	212
EAST	1084	EAST	0.0	0.0	0.0	0.0	0.0	0.0	0	0	0

PROJECT: Philomath TSP ANALYST: BJD
 File: S:\TRANS\PROJECT\ODOT0254\WORKFILE\OPERATIO\SIGOPER2.SIG
 CITY: Philomath PEAKFLOW: PMwBeeKhan 20,000
 DESCRIPTION: 2015- Couplet Alt. 1a

INTERSECTION LOS = D
 SATURATION = 74%

C= 90 G=84 Y= 6

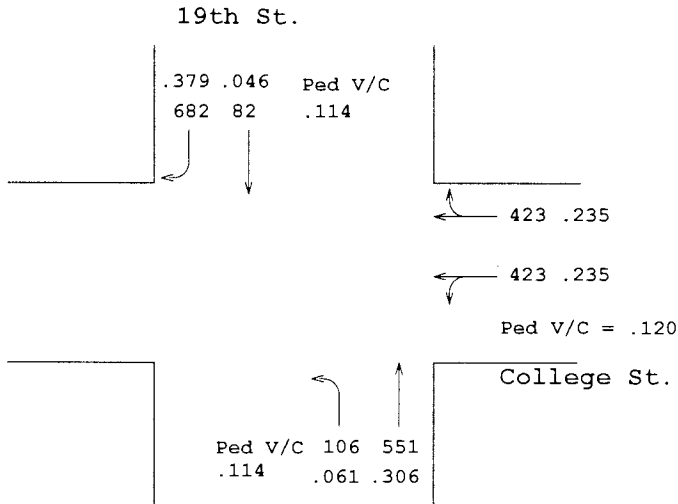

N-S V/C = .440
 E-W V/C = .235
 TOTAL AMBER = .067
 MINIMUM V/C = .067

XXX = Adjusted Volumes .XXX = V/C

APPR	MOVMENT VOLUMES				MOVE SATURATION			MOVEMENT LOS		
	L	T	R	TOT	L	T	R	L	T	R
SOUTH	106	551	0	657	74%	54%	0%	D	B	...
NORTH	0	82	682	764	0%	14%	65%	...	A	C
WEST	0	0	0	0	0%	0%	0%
EAST	98	741	6	845	74%	74%	74%	D	D	D

APPR	TRUCKS %	PED DIST	LANE WIDTH	PHASING
				N-S -LEFT TURNS NOT PROTECTED
EAST	5.0%	45ft	12.ft	E-W -LEFT TURNS NOT PROTECTED

LEG	LEG VOL AT LOS C	APPR	TIME AVAIL(sec)			RED TIME(sec)			MOVE STORAGE(ft)		
			L	T	R	L	T	R	L	T	R
SOUTH	811	SOUTH	54.8	54.8	0.0	32.2	32.2	0.0	52	270	0
NORTH	1279	NORTH	0.0	54.8	54.8	0.0	32.2	32.2	0	40	334
WEST	1481	WEST	0.0	0.0	0.0	0.0	0.0	0.0	0	0	0
EAST	818	EAST	29.2	29.2	29.2	57.8	57.8	57.8	357	357	357

**INTERSECTION 1
SCENARIO 3
MAY 19, 1998**

INTERSECTION = 1 SCENARIO = 3

DATE/TIME: 5/19/98 2:35:08 PM

PROJECT: Philomath TSP

ANALYST: BJD

File: S:\TRANS\PROJECT\ODOT0254\WORKFILE\OPERATIO\SIGOPER2.SIG

CITY: Philomath

PEAK HOUR: PM Peak 20,000

DESCRIPTION: 2015 Couplet Alt. 1b

INTERSECTION LOS = B

SATURATION = 55%

C= 90 G=84 Y= 6

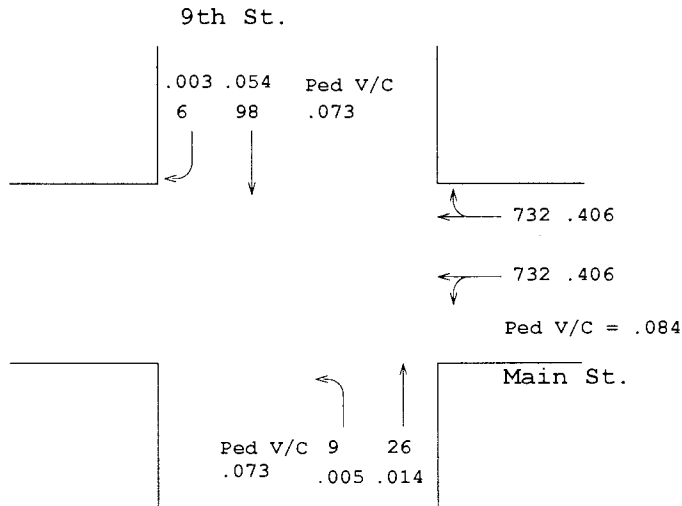

N-S V/C = .073
E-W V/C = .406
TOTAL AMBER = .067
MINIMUM V/C = .067

XXX = Adjusted Volumes .XXX = V/C

APPR	MOVMENT VOLUMES				MOVE SATURATION			MOVEMENT LOS		
	L	T	R	TOT	L	T	R	L	T	R
SOUTH	9	26	0	35	55%	16%	0%	B	A	...
NORTH	0	98	6	104	0%	42%	9%	...	A	A
WEST	0	0	0	0	0%	0%	0%
EAST	0	1384	79	1463	55%	55%	55%	...	B	B

APPR	TRUCKS %	PED DIST	LANE WIDTH	PHASING
SOUTH	5.0%	48ft	12.ft	N-S -LEFT TURNS NOT PROTECTED
NORTH	5.0%	48ft	12.ft	N-S - Right Turn Overlap
WEST	5.0%	40ft	12.ft	E-W -LEFT TURNS NOT PROTECTED
EAST	5.0%	40ft	12.ft	

LEG	LEG VOL AT LOS C	APPR	TIME AVAIL(sec)			RED TIME(sec)			MOVE STORAGE(ft)		
			L	T	R	L	T	R	L	T	R
SOUTH	181	SOUTH	12.8	12.8	0.0	74.2	74.2	0.0	10	28	0
NORTH	285	NORTH	0.0	12.8	12.8	0.0	74.2	74.2	0	105	6
WEST	1906	WEST	0.0	0.0	0.0	0.0	0.0	0.0	0	0	0
EAST	1993	EAST	71.2	71.2	71.2	0.0	15.8	15.8	191	191	191

INTERSECTION = 3 SCENARIO = 2

DATE/TIME: 5/19/98 2:46:24 PM

PROJECT: Philomath TSP

ANALYST: BJD

File: S:\TRANS\PROJECT\ODOT0254\WORKFILE\OPERATIO\SIGOPER2.SIG

CITY: Philomath

PEAKFLOW: PMWEEKhan 20,000

DESCRIPTION: 2015- Couplet Alt. 1b

INTERSECTION LOS = A
SATURATION = 37%

C= 90 G=84 Y= 6

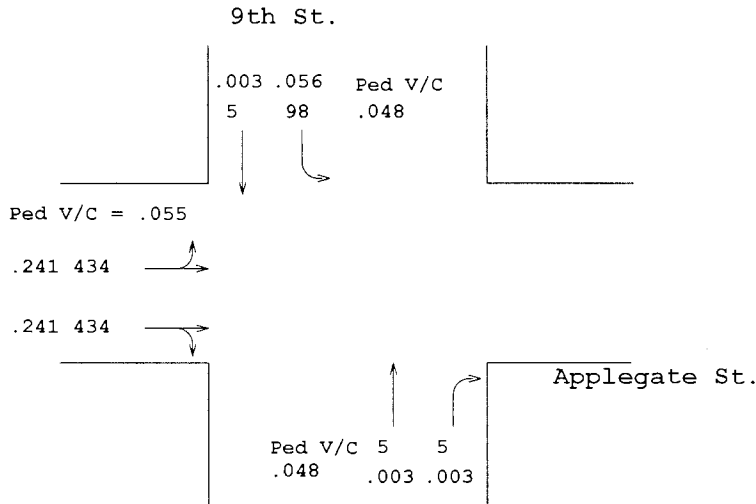

N-S V/C = .067
E-W V/C = .241
TOTAL AMBER = .067
MINIMUM V/C = .067

XXX = Adjusted Volumes .XXX = V/C

APPR	MOVMENT VOLUMES				MOVE SATURATION			MOVEMENT LOS		
	L	T	R	TOT	L	T	R	L	T	R
SOUTH	0	5	5	10	0%	8%	8%	...	A	A
NORTH	98	5	0	103	37%	8%	0%	A	A	...
WEST	34	829	5	868	37%	37%	37%	A	A	A
EAST	0	0	0	0	0%	0%	0%

APPR	TRUCKS %	PED DIST	LANE WIDTH	PHASING
SOUTH	5.0%	48ft	12.ft	N-S -LEFT TURNS NOT PROTECTED
NORTH	5.0%	48ft	12.ft	
WEST	5.0%	40ft	12.ft	E-W -LEFT TURNS NOT PROTECTED
EAST	5.0%	40ft	12.ft	

LEG	LEG VOL AT LOS C	APPR	TIME AVAIL.(sec)			RED TIME (sec)			MOVE STORAGE (ft)		
			L	T	R	L	T	R	L	T	R
SOUTH	42	SOUTH	0.0	18.2	18.2	0.0	68.8	68.8	0	5	5
NORTH	301	NORTH	18.2	18.2	0.0	68.8	68.8	0.0	98	5	0
WEST	1843	WEST	65.8	65.8	65.8	21.2	21.2	21.2	146	146	146
EAST	1978	EAST	0.0	0.0	0.0	0.0	0.0	0.0	0	0	0

INTERSECTION = 4 SCENARIO = 2

DATE/TIME: 5/19/98 2:39:50 PM

PROJECT: Philomath TSP

ANALYST: BJD

File: S:\TRANS\PROJECT\ODOT0254\WORKFILE\OPERATIO\SIGOPER2.SIG

CITY: Philomath

PEAKLAWRN: Pw@eaRhan 20,000

DESCRIPTION: 2015- Couplet Alt. 1b

INTERSECTION LOS = B
SATURATION = 59%

C= 90 G=84 Y= 6

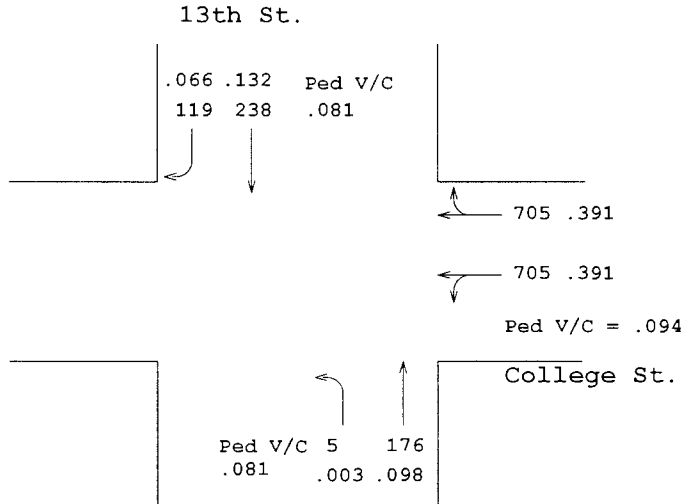

N-S V/C = .135
E-W V/C = .391
TOTAL AMBER = .067
MINIMUM V/C = .067

XXX = Adjusted Volumes .XXX = V/C

APPR	MOVMENT VOLUMES				MOVE SATURATION			MOVEMENT LOS		
	L	T	R	TOT	L	T	R	L	T	R
SOUTH	5	176	0	181	59%	45%	0%	B	A	...
NORTH	0	238	119	357	0%	58%	32%	...	B	A
WEST	0	0	0	0	0%	0%	0%
EAST	4	1161	244	1409	59%	59%	59%	B	B	B

APPR	TRUCKS %	PED DIST	LANE WIDTH	PHASING
SOUTH	5.0%	48ft	12.ft	N-S -LEFT TURNS NOT PROTECTED
NORTH	5.0%	48ft	12.ft	
WEST	5.0%	40ft	12.ft	E-W -LEFT TURNS NOT PROTECTED
EAST	5.0%	40ft	12.ft	

LEG	LEG VOL AT LOS C	APPR	TIME AVAIL(sec)			RED TIME(sec)			MOVE STORAGE(ft)		
			L	T	R	L	T	R	L	T	R
SOUTH	525	SOUTH	21.6	21.6	0.0	65.4	65.4	0.0	5	167	0
NORTH	964	NORTH	0.0	21.6	21.6	0.0	65.4	65.4	0	226	113
WEST	1595	WEST	0.0	0.0	0.0	0.0	0.0	0.0	0	0	0
EAST	1748	EAST	62.4	62.4	62.4	24.6	24.6	24.6	270	270	270

INTERSECTION = 6 SCENARIO = 2

DATE/TIME: 5/22/98 3:49:46 PM

PROJECT: Philomath TSP

ANALYST: BJD

File: S:\TRANS\PROJECT\ODOT0254\WORKFILE\OPERATIO\SIGOPER2.SIG

CITY: Philomath

PERHLAUBN: Pw@eaKhan 20,000

DESCRIPTION: 2015- Couplet Alt. 1b

INTERSECTION LOS = A
SATURATION = 44%

C= 90 G=84 Y= 6

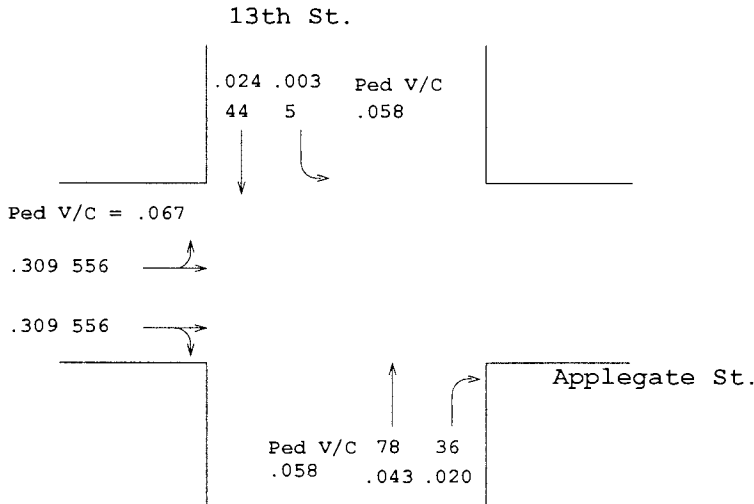

N-S V/C = .067
E-W V/C = .309
TOTAL AMBER = .067
MINIMUM V/C = .067

XXX = Adjusted Volumes .XXX = V/C

APPR	MOVMENT VOLUMES				MOVE SATURATION			MOVEMENT LOS		
	L	T	R	TOT	L	T	R	L	T	R
SOUTH	0	78	36	114	0%	31%	18%	...	A	A
NORTH	5	44	0	49	41%	20%	0%	A	A	...
WEST	112	968	32	1112	44%	44%	44%	A	A	A
EAST	0	0	0	0	0%	0%	0%

APPR	TRUCKS %	PED DIST	LANE WIDTH	PHASING
SOUTH	5.0%	48ft	12.ft	N-S -LEFT TURNS NOT PROTECTED
NORTH	5.0%	48ft	12.ft	
WEST	5.0%	40ft	12.ft	E-W -LEFT TURNS NOT PROTECTED
EAST	5.0%	40ft	12.ft	

LEG	LEG VOL AT LOS C	APPR	TIME AVAIL(sec)			RED TIME(sec)			MOVE STORAGE(ft)		
			L	T	R	L	T	R	L	T	R
SOUTH	331	SOUTH	0.0	14.9	14.9	0.0	72.1	72.1	0	81	38
NORTH	416	NORTH	14.9	14.9	0.0	72.1	72.1	0.0	5	46	0
WEST	1934	WEST	69.1	69.1	69.1	17.9	17.9	17.9	161	161	161
EAST	1755	EAST	0.0	0.0	0.0	0.0	0.0	0.0	0	0	0

INTERSECTION = 7 SCENARIO = 2

DATE/TIME: 5/19/98 2:29:04 PM

PROJECT: Philomath TSP

ANALYST: BJD

File: S:\TRANS\PROJECT\ODOT0254\WORKFILE\OPERATIO\SIGOPER2.SIG

CITY: Philomath

PEAK HOUR: PM Peak 20,000

DESCRIPTION: 2015 Couplet Alt 1b

INTERSECTION LOS = B

SATURATION = 53%

C= 90 G=84 Y= 6

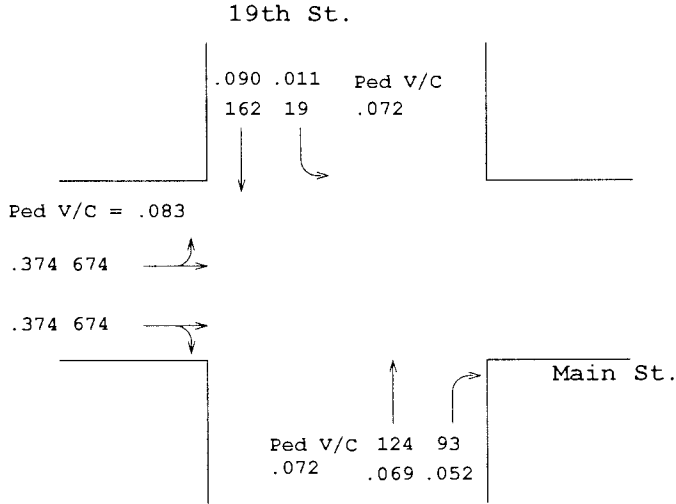

N-S V/C = .090
E-W V/C = .374
TOTAL AMBER = .067
MINIMUM V/C = .067

XXX = Adjusted Volumes .XXX = V/C

APPR	MOVMENT VOLUMES				MOVE SATURATION			MOVEMENT LOS		
	L	T	R	TOT	L	T	R	L	T	R
SOUTH	0	124	93	217	0%	42%	33%	...	A	A
NORTH	19	162	0	181	49%	53%	0%	B	B	...
WEST	354	890	104	1348	53%	53%	53%	B	B	B
EAST	0	0	0	0	0%	0%	0%

APPR	TRUCKS %	PED DIST	LANE WIDTH	PHASING
SOUTH	5.0%	48ft	12.ft	N-S -LEFT TURNS NOT PROTECTED
NORTH	5.0%	48ft	12.ft	N-S - Right Turn Overlap
WEST	5.0%	40ft	12.ft	E-W -LEFT TURNS NOT PROTECTED
EAST	5.0%	40ft	12.ft	

LEG	LEG VOL AT LOS C	APPR	TIME AVAIL(sec)			RED TIME(sec)			MOVE STORAGE(ft)		
			L	T	R	L	T	R	L	T	R
SOUTH	679	SOUTH	0.0	16.3	16.3	0.0	70.7	70.7	0	127	95
NORTH	927	NORTH	16.3	16.3	0.0	70.7	70.7	0.0	19	166	0
WEST	1896	WEST	67.7	67.7	67.7	19.3	19.3	19.3	209	209	209
EAST	1410	EAST	0.0	0.0	0.0	0.0	0.0	0.0	0	0	0

INTERSECTION = 5 SCENARIO = 2

DATE/TIME: 5/29/98 9:53:17 AM

PROJECT: Philomath TSP

ANALYST: BJD

File: S:\TRANS\PROJECT\ODOT0254\WORKFILE\OPERATIO\SIGOPER2.SIG

CITY: Philomath

PEAK HOUR: PwPeakhan 20,000

DESCRIPTION: 2015- Couplet Alt. 1b

INTERSECTION LOS = D
SATURATION = 83%

C= 60 G=54 Y= 6

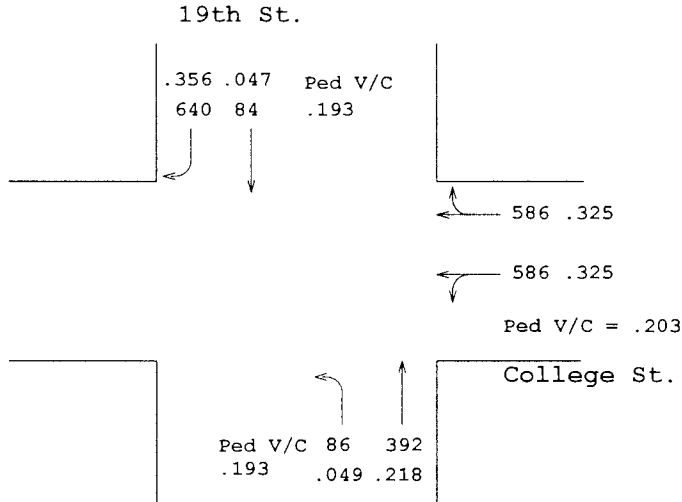

N-S V/C = .405
E-W V/C = .325
TOTAL AMBER = .100
MINIMUM V/C = .100

XXX = Adjusted Volumes .XXX = V/C

APPR	MOVMENT VOLUMES				MOVE SATURATION			MOVEMENT LOS		
	L	T	R	TOT	L	T	R	L	T	R
SOUTH	86	392	0	478	83%	49%	0%	D	B	...
NORTH	0	84	640	724	0%	18%	74%	...	A	D
WEST	0	0	0	0	0%	0%	0%
EAST	98	1065	8	1171	83%	83%	83%	D	D	D

APPR	TRUCKS %	PED DIST	LANE WIDTH	PHASING
SOUTH	5.0%	48ft	12.ft	N-S -LEFT TURNS NOT PROTECTED
NORTH	5.0%	48ft	12.ft	
WEST	5.0%	45ft	12.ft	E-W -LEFT TURNS NOT PROTECTED
EAST	5.0%	45ft	12.ft	

LEG	LEG VOL AT LOS C	APPR	TIME AVAIL(sec)			RED TIME(sec)			MOVE STORAGE(ft)		
			L	T	R	L	T	R	L	T	R
SOUTH	560	SOUTH	29.9	29.9	0.0	27.1	27.1	0.0	36	164	0
NORTH	954	NORTH	0.0	29.9	29.9	0.0	27.1	27.1	0	35	267
WEST	1521	WEST	0.0	0.0	0.0	0.0	0.0	0.0	0	0	0
EAST	994	EAST	24.1	24.1	24.1	32.9	32.9	32.9	292	292	292

**UNIGNALIZED – T INTERSECTION CAPACITY CALCULATION
FORM**

UNSIGNALIZED - T - INTERSECTION CAPACITY CALCULATION FORM

5/27/1998 13:10:42

FILE NAME: h2034xtn

CITY: Philomath ANALYST: BJD
 INTERSECTION: Hwy. 20 at Hwy. 34 North
 ALTERNATE: 2015- Ext. Couplet N METRO SIZE: LESS THAN 20,000
 COUNT: PM Peak TYPE OF CONTROL: STOP
 LOCATION PLAN:

APPROACH CODES ARE

LANE	1	2	3	4	-----	
A	0			A		B
B	2	2	3			
C	3				GRADE= .0%	
						GRADE= .0%
						GRADE= .0%

SPEED: 40 MPH
 RESTRICTED SIGHT CODE IS 1
 MINOR STREET ADJUSTMENTS -
 ACCELERATION LANE? NO
 CURB RADIUS OR TURN ANGLE? NO

APPROACH	A		B		C	
MOVE	AT	AR	BL	BT	CL	CR
VOLUME	0	0	368	699	10	0
PCH			405		11	0
LANES		0		3		1

STEP 1 RIGHT TURN FROM C CR
 CONFLICTING FLOWS = MH = 0. VPH
 CRITICAL GAP = TG = 6.0 SECS
 POTENTIAL CAPACITY = M1 = 1012. PCH
 SHARED LANE - SEE STEP 3
 NO SHARED LANE DEMAND = 0 PCH
 AVAILABLE RESERVE = 1012. PCH
 DELAY & LOS = A

STEP 2 LEFT TURN FROM B BL
 CONFLICTING FLOWS = MH = 0. VPH
 CRITICAL GAP = TG = 5.5 SECS
 POTENTIAL CAPACITY = M2 = 1105. PCH
 DEMAND = BL = 405 PCH
 CAPACITY USED = 36.65 %
 IMPEDANCE FACTOR = P2 = .714
 AVAILABLE RESERVE = 700. PCH
 DELAY & LOS = A

STEP 3 LEFT TURN FROM C CL
 CONFLICTING FLOWS = MH = 1067. VPH
 CRITICAL GAP = TG = 6.5 SECS
 POTENTIAL CAPACITY = M3 = 200. PCH
 ADJUSTING FOR IMPEDANCE = M3 = 143. PCH

STEP 3 CONTINUED

CL

NO SHARED LANE DEMAND =	0	PCH
AVAILABLE RESERVE =	0.	PCH
DELAY & LOS =	N/A	

SHARED LANE DEMAND =	11	PCH
POTENTIAL CAPACITY = M13 =	141.	PCH
AVAILABLE RESERVE =	130.	PCH
DELAY & LOS =	D	

LOS C VOLUMES:
VEHICLES PER HOUR

LEG C
281.

VER 03/93

**UNSIGNALIZED – INTERSECTION CAPACITY CALCULATION
FORM
4-WAY INTERSECTION**

UNSIGNALIZED INTERSECTION CAPACITY CALCULATION FORM
4-WAY INTERSECTION

5/27/1998 13:20:23

FILE NAME: h2034xts

CITY: Philomath
INTERSECTION: Hwy 20 at Hwy 34 (South)
ALTERNATE: 2015-Ext. Couplet So
COUNT: PM Peak
LOCATION PLAN:

ANALYST: BJD
METRO SIZE: LESS THAN 20,000
TYPE OF CONTROL: STOP

APPROACH CODES ARE

LANE	1	2	3	4	GRADE=	.0%
A	1	2	2			
B	0					
C	1	2				
D	2	3				

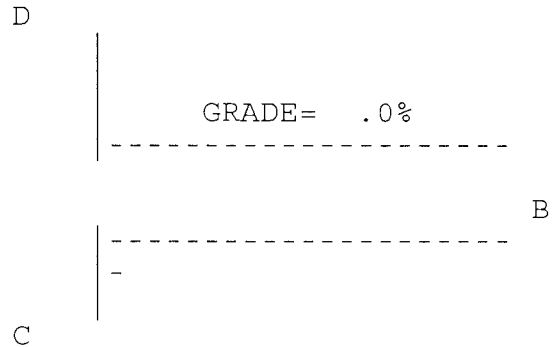

SPEED: 40 MPH
RESTRICTED SIGHT CODE IS 1
MINOR STREET ADJUSTMENTS -
ACCELERATION LANE? NO
CURB RADIUS OR TURN ANGLE? NO

APPR	A			B			C			D		
MOVE	AL	AT	AR	BL	BT	BR	CL	CT	CR	DL	DT	DR
VOL	5	512	9	0	0	0	0	10	219	5	300	0
PCH	6			0			0	11	241	6	330	0
LANES		3			0			2			2	

STEP 1 RIGHT TURN FROM C/D

	CR	DR
CONFLICTING FLOWS = MH =	256.	0. VPH
CRITICAL GAP = TG =	6.0	6.0 SECS
POTENTIAL CAPACITY = M1 =	739.	1012. PCH
DEMAND =	241	0 PCH
CAPACITY USED =	32.606	.000 %
IMPEDANCE FACTOR =	.750	1.001

SHARED LANE - SEE STEP 3

NO SHARED LANE - RESERVE =	498.	0. PCH
DELAY & LOS =	A	N/A

STEP 2 - LEFT TURNS FROM B/A

	BL	AL
CONFLICTING FLOWS = MH =	0.	0. VPH
CRITICAL GAP = TG =	5.5	5.5 SECS
POTENTIAL CAPACITY = M2 =	601.	1105. PCH
DEMAND =	0	6 PCH
CAPACITY USED =	.00	.54 %
IMPEDANCE FACTOR =	1.001	.997
AVAILABLE RESERVE =	0.	1099. PCH
DELAY & LOS =	N/A	A

STEP 3 THRU MOVEMENT FROM C/D

	CT	DT
CONFLICTING FLOWS = MT =	517.	526. VPH
CRITICAL GAP = TG =	7.0	7.0 SECS
POTENTIAL CAPACITY = MN3 =	416.	410. PCH
IMPEDANCE ADJUSTMENT = M3 =	415.	409. PCH
DEMAND =	11	330 PCH
CAPACITY USED =	2.65	80.50 %
IMPEDANCE FACTOR = P3 =	.983	.260

NO SHARED LANE

AVAILABLE RESERVE=	404.	79. PCH
DELAY & LOS =	A	E

SHARED LANE WITH LEFT TURN - SEE STEP 4

SHARED LANE DEMAND =	0	0 PCH
POTENTIAL CAPACITY = M13 =	0.	0. PCH
AVAILABLE RESERVE =	0.	0. PCH
DELAY & LOS =	N/A	N/A

STEP 4 - LEFT TURN FROM C/D

	CL	DL
CONFLICTING FLOWS = MH =	817.	755. VPH
CRITICAL GAP = TG =	6.5	6.5 SECS
POTENTIAL CAPACITY = MN =	300.	330. PCH
ADJUST FOR IMPEDANCE:	78.	243. PCH

NO SHARED LANE DEMAND =	0	6 PCH
AVAILABLE RESERVE =	0.	237. PCH
DELAY & LOS =	N/A	C

WITH LEFT & THRU

SHARED LANE DEMAND =	0	0 PCH
CAPACITY OF SHARED LANE =	0.	0. PCH
AVAILABLE RESERVE =	0.	0. PCH
DELAY & LOS =	N/A	N/A

WITH LEFT, THRU, & RIGHT

SHARED LANE DEMAND =	0	0 PCH
CAPACITY OF SHARED LANE =	0.	0. PCH
AVAILABLE RESERVE =	0.	0. PCH
DELAY & LOS =	N/A	N/A

LOS C VOLUMES:
VEHICLES PER HOUR

FOR LEG C
579.

FOR LEG D
444.

INTERSECTION 8
SCENARIO 2
JUNE 1, 1998

INTERSECTION = 8 SCENARIO = 2 DATE/TIME: 6/1/98 2:09:19 PM

PROJECT: Philomath TSP ANALYST: BJD
 File: S:\TRANS\PROJECT\ODOT0254\WORKFILE\OPERATIO\SIGOPER2.SIG
 CITY: Philomath PERKLEURN: PwseaRhan 20,000
 DESCRIPTION: 2015 -Widen Main to Five Lanes

INTERSECTION LOS = C
 SATURATION = 67%

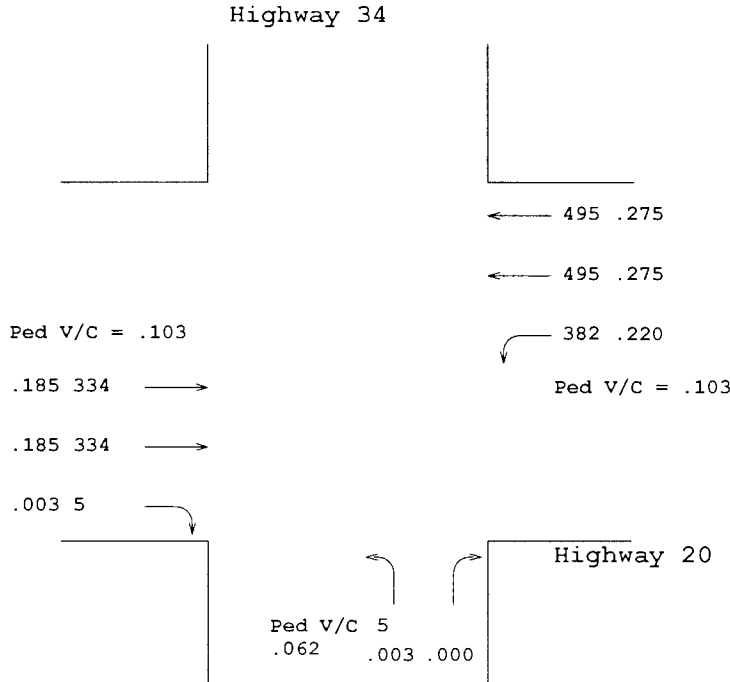

C= 90 G=78 Y= 12



N-S V/C = .133
 E-W V/C = .405
 TOTAL AMBER = .133
 MINIMUM V/C = .067

XXX = Adjusted Volumes .XXX = V/C

APPR	MOVMENT VOLUMES				MOVE SATURATION			MOVEMENT LOS		
	L	T	R	TOT	L	T	R	L	T	R
SOUTH	5	0	196	201	16%	0%	0%	A	...	A
NORTH	0	0	0	0	0%	0%	0%
WEST	0	667	5	672	0%	67%	14%	...	C	A
EAST	382	990	0	1372	67%	50%	0%	C	B	...

APPR	TRUCKS %	PED DIST	LANE WIDTH	PHASING
				SOUTH
NORTH	5.0%	48ft	12.ft	N-S - Right Turn Overlap
WEST	5.0%	24ft	12.ft	E-W -LEFT TURNS PROTECTED WITH OVERLAP
EAST	5.0%	24ft	12.ft	

LEG	LEG VOL AT LOS C	APPR	TIME AVAIL(sec)			RED TIME(sec)			MOVE STORAGE(ft)		
			L	T	R	L	T	R	L	T	R
SOUTH	641	SOUTH	9.7	0.0	31.8	77.3	0.0	55.2	6	0	158
NORTH	0	NORTH	0.0	0.0	0.0	0.0	0.0	0.0	0	0	0
WEST	1817	WEST	0.0	26.9	26.9	0.0	60.1	60.1	0	292	4
EAST	2436	EAST	31.8	58.7	0.0	55.2	28.3	0.0	309	215	0

PROJECT: Philomath TSP ANALYST: BJD
 File: S:\TRANS\PROJECT\ODOT0254\WORKFILE\OPERATIO\SIGOPER2.SIG
 CITY: Philomath PEBLLOWRN: Pw2eaXhan 20,000
 DESCRIPTION: 2015 -Widen Main to Five Lanes

INTERSECTION LOS = C
 SATURATION = 63%

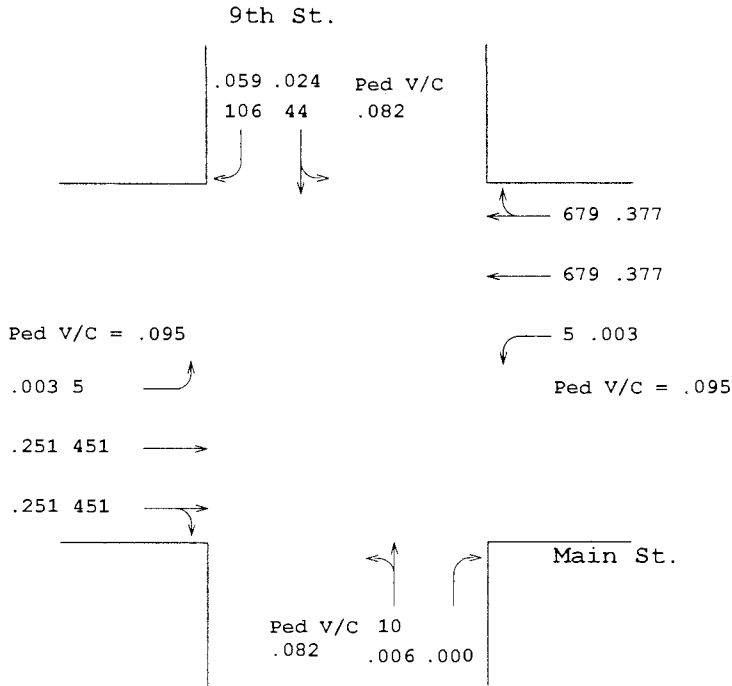

C= 90 G=81 Y= 9



N-S V/C = .082
 E-W V/C = .444
 TOTAL AMBER = .100
 MINIMUM V/C = .067

XXX = Adjusted Volumes .XXX = V/C

APPR	MOVMENT VOLUMES				MOVE SATURATION			MOVEMENT LOS		
	L	T	R	TOT	L	T	R	L	T	R
SOUTH	5	5	5	15	63%	63%	0%	C	C	A
NORTH	39	5	111	155	63%	63%	31%	C	C	A
WEST	5	897	5	907	12%	45%	45%	A	A	A
EAST	5	1281	77	1363	12%	63%	63%	A	C	C

APPR	TRUCKS %	PED DIST	LANE WIDTH	PHASING
SOUTH	5.0%	48ft	12.ft	N-S -LEFT TURNS NOT PROTECTED
NORTH	5.0%	48ft	12.ft	N-S - Right Turn Overlap
WEST	5.0%	40ft	12.ft	E-W -LEFT TURNS PROTECTED WITH OVERLAP
EAST	5.0%	40ft	12.ft	

LEG	LEG VOL AT LOS C	APPR	TIME AVAIL(sec)			RED TIME(sec)			MOVE STORAGE(ft)		
			L	T	R	L	T	R	L	T	R
SOUTH	35	SOUTH	12.6	12.6	22.9	74.4	74.4	64.1	11	11	5
NORTH	285	NORTH	12.6	12.6	22.9	74.4	74.4	64.1	47	47	103
WEST	2717	WEST	10.3	58.1	58.1	76.7	28.9	28.9	6	200	200
EAST	2717	EAST	10.3	58.1	58.1	76.7	28.9	28.9	6	301	301

PROJECT: Philomath TSP ANALYST: BJD
 File: S:\TRANS\PROJECT\ODOT0254\WORKFILE\OPERATIO\SIGOPER2.SIG
 CITY: Philomath PEBHLAOWBN: FmwBeeKhan 20,000
 DESCRIPTION: 2015 - Widen Main to Five Lanes

INTERSECTION LOS = C-D
 SATURATION = 72%

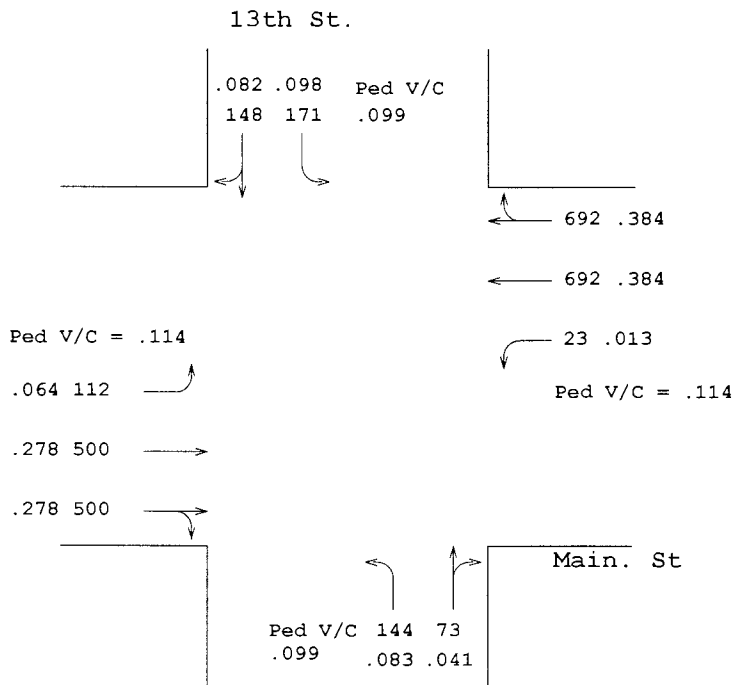

C= 90 G=81 Y= 9



N-S V/C = .165
 E-W V/C = .451
 TOTAL AMBER = .100
 MINIMUM V/C = .067

XXX = Adjusted Volumes .XXX = V/C

APPR	MOVMENT VOLUMES				MOVE SATURATION			MOVEMENT LOS		
	L	T	R	TOT	L	T	R	L	T	R
SOUTH	144	50	23	217	72%	25%	25%	C-D	A	A
NORTH	171	29	119	319	72%	41%	41%	C-D	A	A
WEST	112	940	60	1112	69%	55%	55%	C	B	B
EAST	23	1245	138	1406	22%	72%	72%	A	C-D	C-D

APPR	TRUCKS %	PED DIST	LANE WIDTH	PHASING
				N-S -LEFT TURNS NOT PROTECTED
EAST	5.0%	40ft	12.ft	E-W -LEFT TURNS PROTECTED WITH OVERLAP

LEG	LEG VOL AT LOS C	APPR	TIME AVAIL(sec)			RED TIME(sec)			MOVE STORAGE(ft)		
			L	T	R	L	T	R	L	T	R
SOUTH	331	SOUTH	21.7	21.7	21.7	65.3	65.3	65.3	137	69	69
NORTH	623	NORTH	21.7	21.7	21.7	65.3	65.3	65.3	162	140	140
WEST	2638	WEST	8.8	50.5	50.5	78.2	36.5	36.5	126	274	274
EAST	2557	EAST	8.8	50.5	50.5	78.2	36.5	36.5	26	379	379

PROJECT: Philomath TSP ANALYST: BJD
 File: S:\TRANS\PROJECT\ODOT0254\WORKFILE\OPERATIO\SIGOPER2.SIG
 CITY: Philomath PEAKFLOW: Pw@e@han 20,000
 DESCRIPTION: 2015 - Widen Main to Five Lanes

INTERSECTION LOS = D
 SATURATION = 77%

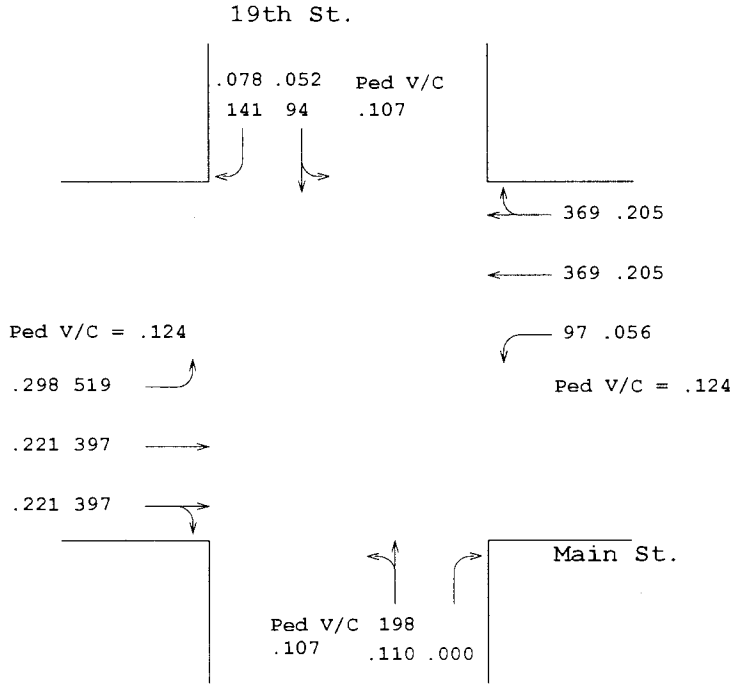

C= 90 G=81 Y= 9



N-S V/C = .165
 E-W V/C = .503
 TOTAL AMBER = .100
 MINIMUM V/C = .067

XXX = Adjusted Volumes .XXX = v/c

APPR	MOVMENT VOLUMES				MOVE SATURATION			MOVEMENT LOS		
	L	T	R	TOT	L	T	R	L	T	R
SOUTH	151	47	63	261	77%	77%	0%	D	D	A
NORTH	10	84	678	772	77%	77%	21%	D	D	A
WEST	519	676	118	1313	77%	44%	44%	D	A	A
EAST	97	734	4	835	66%	77%	77%	C	D	D

APPR	TRUCKS %	PED DIST	LANE WIDTH	PHASING
SOUTH	5.0%	48ft	12.ft	N-S -LEFT TURNS NOT PROTECTED
NORTH	5.0%	48ft	12.ft	N-S - Right Turn Overlap
WEST	5.0%	40ft	12.ft	E-W -LEFT TURNS PROTECTED WITH OVERLAP
EAST	5.0%	40ft	12.ft	

LEG	LEG VOL AT LOS C	APPR	TIME AVAIL(sec)			RED TIME(sec)			MOVE STORAGE(ft)		
			L	T	R	L	T	R	L	T	R
SOUTH	519	SOUTH	20.0	20.0	28.1	67.0	67.0	58.9	192	192	54
NORTH	1245	NORTH	20.0	20.0	56.2	67.0	67.0	30.8	91	91	319
WEST	2668	WEST	36.1	52.9	52.9	50.9	34.1	34.1	388	205	205
EAST	1469	EAST	8.1	24.8	24.8	78.9	62.2	62.2	110	334	334

**INTERSECTION 3
SCENARIO 1
JUNE 3, 1998**

INTERSECTION = 3 SCENARIO = 1

DATE/TIME: 6/3/98 11:15:39 AM

PROJECT: Philomath TSP
 File: C:\SIGCAP2\SIGOPER4.sig
 CITY: Philomath
 DESCRIPTION: 2015- West Hills Rd. Ext

ANALYST: BJD
 PEAK HOUR: PM Peak
 POPULATION: Fewer Than 20,000

INTERSECTION LOS = C
 SATURATION = 66%

C= 90 G=81 Y= 9

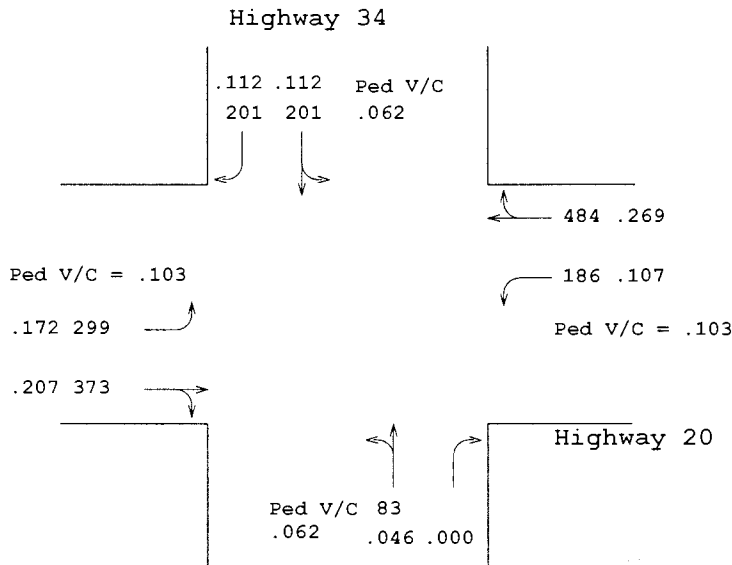

N-S V/C = .115
 E-W V/C = .441
 TOTAL AMBER = .100
 MINIMUM V/C = .067

XXX = Adjusted Volumes .XXX = V/C

APPR	MOVMENT VOLUMES				MOVE SATURATION			MOVEMENT LOS		
	L	T	R	TOT	L	T	R	L	T	R
SOUTH	5	78	118	201	66%	66%	0%	C	C	A
NORTH	5	196	510	711	66%	66%	32%	C	C	A
WEST	299	368	5	672	66%	44%	44%	C	A	A
EAST	186	479	5	670	66%	66%	66%	C	C	C

APPR	TRUCKS %	PED DIST	LANE WIDTH	PHASING
SOUTH	5.0%	48ft	12.ft	N-S -LEFT TURNS NOT PROTECTED
NORTH	5.0%	48ft	12.ft	N-S - Right Turn Overlap
WEST	5.0%	24ft	12.ft	E-W -LEFT TURNS PROTECTED WITH OVERLAP
EAST	5.0%	24ft	12.ft	

LEG	LEG VOL AT LOS C	APPR	TIME AVAIL(sec)			RED TIME(sec)			MOVE STORAGE(ft)		
			L	T	R	L	T	R	L	T	R
SOUTH	657	SOUTH	16.7	16.7	32.3	70.3	70.3	54.7	84	84	95
NORTH	1220	NORTH	16.7	16.7	41.8	70.3	70.3	45.2	205	205	342
WEST	1860	WEST	25.1	48.7	48.7	61.9	38.3	38.3	270	214	214
EAST	1296	EAST	15.6	39.2	39.2	71.4	47.8	47.8	192	341	341

INTERSECTION = 2 SCENARIO = 1

DATE/TIME: 6/3/98 11:18:00 AM

PROJECT: Philomath TSP
 File: C:\SIGCAP2\SIGOPER4.sig
 CITY: Philomath
 DESCRIPTION: 2015- West Hills Rd. Ext.

ANALYST: BJD
 PEAK HOUR: PM Peak
 POPULATION: Fewer Than 20,000

INTERSECTION LOS = C-D
 SATURATION = 72%

C= 90 G=81 Y= 9

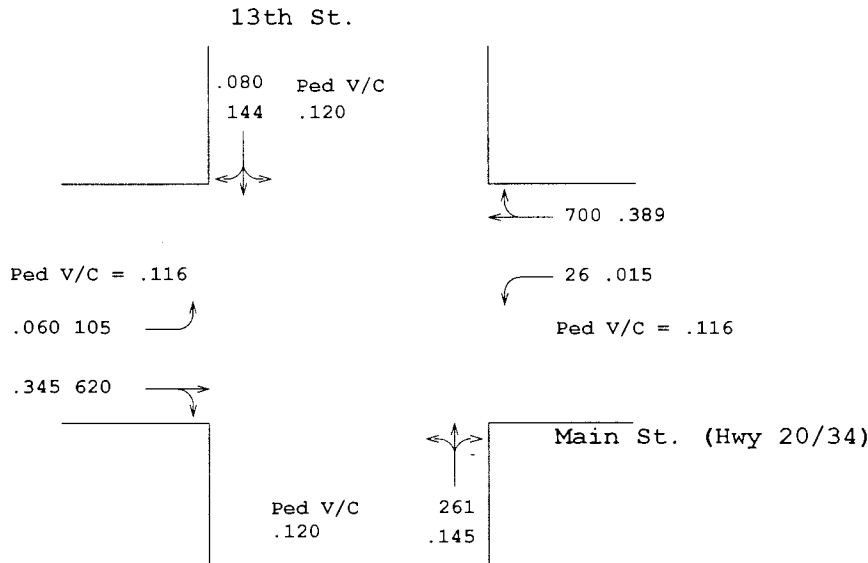

N-S V/C = .169
 E-W V/C = .456
 TOTAL AMBER = .100
 MINIMUM V/C = .067

XXX = Adjusted Volumes .XXX = V/C

APPR	MOVMENT VOLUMES				MOVE SATURATION			MOVEMENT LOS		
	L	T	R	TOT	L	T	R	L	T	R
SOUTH	99	77	85	261	72%	72%	64%	C-D	C-D	C
NORTH	42	40	62	144	72%	72%	40%	C-D	C-D	A
WEST	95	482	82	659	66%	65%	65%	C	C	C
EAST	26	643	57	726	72%	72%	72%	A	C-D	C-D

APPR	TRUCKS %	PED DIST	LANE WIDTH	PHASING
SOUTH	2.0%	48ft	12.ft	N-S -LEFT TURNS NOT PROTECTED
NORTH	2.0%	48ft	12.ft	
WEST	15.0%	50ft	12.ft	E-W -LEFT TURNS PROTECTED WITH OVERLAP
EAST	5.0%	50ft	12.ft	

LEG	LEG VOL AT LOS C	APPR	TIME AVAIL (sec)			RED TIME (sec)			MOVE STORAGE (ft)		
			L	T	R	L	T	R	L	T	R
SOUTH	406	SOUTH	21.9	21.9	21.9	65.1	65.1	65.1	247	247	247
NORTH	370	NORTH	21.9	21.9	21.9	65.1	65.1	65.1	136	136	136
WEST	1452	WEST	8.6	50.4	50.4	78.4	36.6	36.6	118	341	341
EAST	1325	EAST	8.6	50.4	50.4	78.4	36.6	36.6	29	385	385

INTERSECTION = 1 SCENARIO = 1

DATE/TIME: 6/3/98 10:35:27 AM

PROJECT: Philomath TSP
 File: C:\SIGCAP2\SIGOPER4.sig
 CITY: Philomath
 DESCRIPTION: 2015- West Hills Rd. Ext.

ANALYST: BJD
 PEAK HOUR: PM Peak
 POPULATION: Fewer Than 20,000

INTERSECTION LOS = D-E
 SATURATION = 87%

C= 90 G=81 Y= 9

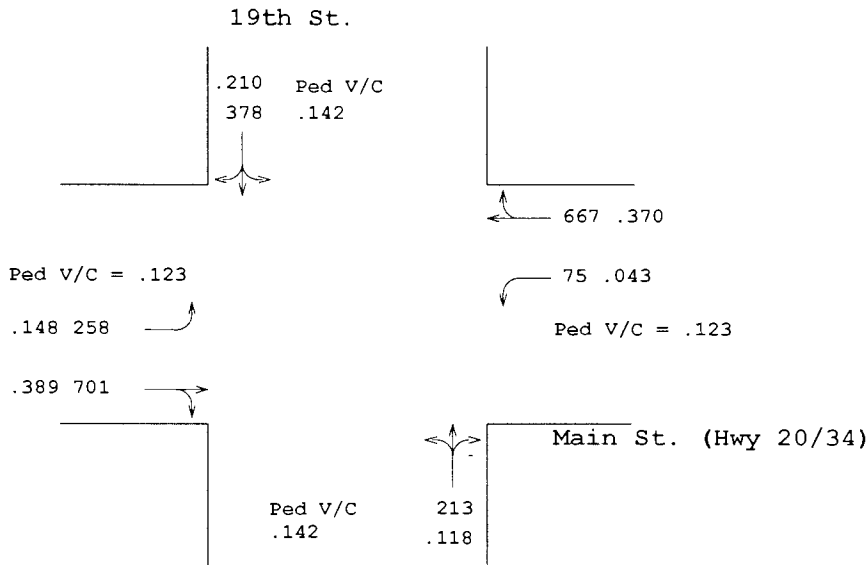

N-S V/C = .249
 E-W V/C = .519
 TOTAL AMBER = .100
 MINIMUM V/C = .067

XXX = Adjusted Volumes .XXX = V/C

APPR	MOVMENT VOLUMES				MOVE SATURATION			MOVEMENT LOS		
	L	T	R	TOT	L	T	R	L	T	R
SOUTH	68	73	72	213	87%	87%	47%	D-E	D-E	A
NORTH	15	120	228	363	87%	87%	75%	D-E	D-E	D
WEST	237	547	96	880	87%	76%	76%	D-E	D	D
EAST	70	617	6	693	60%	87%	87%	C	D-E	D-E

APPR	TRUCKS %	PED DIST	LANE WIDTH	PHASING
SOUTH	5.0%	22ft	12. ft	N-S -LEFT TURNS NOT PROTECTED
NORTH	9.0%	40ft	12. ft	
WEST	14.0%	48ft	12. ft	E-W -LEFT TURNS PROTECTED WITH OVERLAP
EAST	12.0%	48ft	12. ft	

LEG	LEG VOL AT LOS C	APPR	TIME AVAIL(sec)			RED TIME(sec)			MOVE STORAGE(ft)		
			L	T	R	L	T	R	L	T	R
SOUTH	403	SOUTH	26.3	26.3	26.3	60.7	60.7	60.7	189	189	189
NORTH	548	NORTH	26.3	26.3	26.3	60.7	60.7	60.7	334	334	334
WEST	1448	WEST	15.7	47.7	47.7	71.3	39.3	39.3	267	412	412
EAST	1072	EAST	7.0	39.1	39.1	80.0	47.9	47.9	86	471	471

APPENDIX F
PEDESTRIAN IMPROVEMENT STRATEGIES

APPENDIX F PEDESTRIAN IMPROVEMENT STRATEGIES

The following is based on information from the *Oregon Bicycle and Pedestrian Plan*

A. IMPROVING PEDESTRIAN CROSSING OPPORTUNITIES

To increase pedestrian crossing opportunities and safety in Philomath, two approaches can be considered:

1. Designing roads that allow crossings to occur safely by incorporating design features such as raised medians or signal timing that creates gaps in traffic; or
2. Constructing actual pedestrian crossings with pedestrian activated signals, mid-block curb extensions, marked crosswalks, etc.

A.1. ISSUES

Safe and convenient pedestrian crossings must be considered when planning and designing roadways. The following issues should be addressed when seeking solutions to specific problems:

A.1.a. Level of Service (LOS) and Design Standards

Appropriate design standards take into account the needs of all users. Pedestrian access and mobility should be considered when determining the desirable LOS for a roadway. In some areas, pedestrian needs should be elevated above the needs of motorized traffic (e.g. near the schools). Pedestrians are less visible and less protected than motorists; well-designed roads take this into account.

In general, there is an inverse relationship between traffic volumes or speeds and the ease of pedestrian crossing, which can lead to conflicting goals when determining priorities for a roadway:

- Some motor vehicle designs may reduce pedestrian crossing safety (e.g. a number of wide travel lanes increases the distance a pedestrian must cross);
- Some designs that facilitate pedestrian crossings may reduce capacity (e.g. pedestrian signals);
- Other design features benefit all users (e.g. improved sight distance at intersections and raised medians).

In some cases, actual travel speeds may be higher than is appropriate for the adjacent land use, and improvements that facilitate crossing may be useful in reducing traffic speeds to desirable and legal limits. Minor collectors and residential streets often carry more fast-moving traffic than the street is designed to carry. The design of a road should not encourage

excessive speeds; even a major arterial such as US20/OR34, can be treated for pedestrian safety without significantly degrading capacity.

As the number and density of pedestrian-accessible origin and destination points increase, so does the demand for pedestrian crossings. On corridors with scattered development and residences, it is difficult to predict where crossings may occur. On corridors with concentrated nodes of activity, (such as US 20/OR 34, and collector streets), special crossing treatments are easier to justify at locations where crossings will likely occur (shopping areas, apartment complexes, schools, parks, and public and institutional uses) These and similar types of land uses are sometimes referred to as “pedestrian generating uses”.

Land use planning and transportation engineering must work together to ensure that land use is compatible with the roadway design, and vice versa.

A.1.c. Access Management

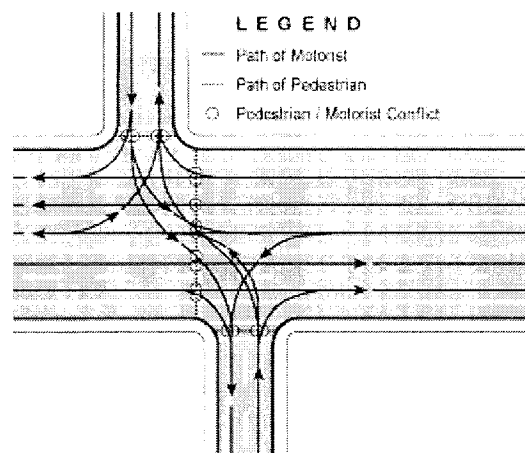

Figure X: Accesses create additional conflicts for crossing pedestrians

Many uncontrolled accesses to a busy road decrease pedestrian crossing opportunities: when a gap is created in the traffic stream, motorists entering the road fill the gap. Pedestrians seeking refuge in a center turn lane are unprotected. One access management tool benefits pedestrian crossing: well-designed raised center medians provide a refuge for pedestrians, so they can cross one direction of traffic at a time.

However, eliminating road connections and signals also eliminates potential pedestrian crossing opportunities. Creating an urban freeway can increase traffic speeds and volumes. Concrete barriers placed down the middle of the road (rather than a raised median) effectively prohibit pedestrian crossings.

A.1.d. Perception of Safety at Crosswalks

Some studies have indicated that pedestrians may develop a "false sense of security" when crossing a road in marked crosswalks. Other studies have indicated that motorists are more likely to stop for pedestrians in marked crosswalks, especially where the right-of-way laws are enforced. Proper design makes it clear who has the right-of-way.

A.1.e. Maintenance

The effectiveness of a design will be lost if maintenance is excessively difficult or expensive. Forethought must be given to the practicality of future maintenance. Facilities will be effective over time only if they are in good condition. Examples of design features to be avoided include:

- Blind corners that can accumulate debris;
- Restricted areas that cannot accommodate sweepers or other power equipment; and
- Remote areas requiring hand maintenance, such as sweeping.

A.2. SOLUTIONS

No one solution is applicable in all situations as the issues will usually overlap on any given section of road. In most cases, a combination of measures will be needed to improve pedestrian crossing opportunities and safety.

A.2.a. Raised Medians

These benefit pedestrians on two-way, multi-lane streets, as they allow pedestrians to cross only one direction of traffic at a time: it takes much longer to cross four lanes of traffic than two. Where raised medians are used for access management, they should be constructed so they provide a pedestrian refuge.

Where it is not possible to provide a continuous raised median, island refuges can be created between intersections and other accesses. These should be located across from high pedestrian generators such as schools, parks, municipal buildings, parking lots, etc.

In most instances, the width of the raised median is the width of the center turn-lane, minus the necessary shy distance on each side. Ideally, raised medians should be constructed with a smooth, traversable surface, such as brick pavers. Medians should be landscaped with the plants low enough so they do not obstruct visibility, and spaced far enough apart to allow passage by pedestrians.

A.2.b. Curb Extensions

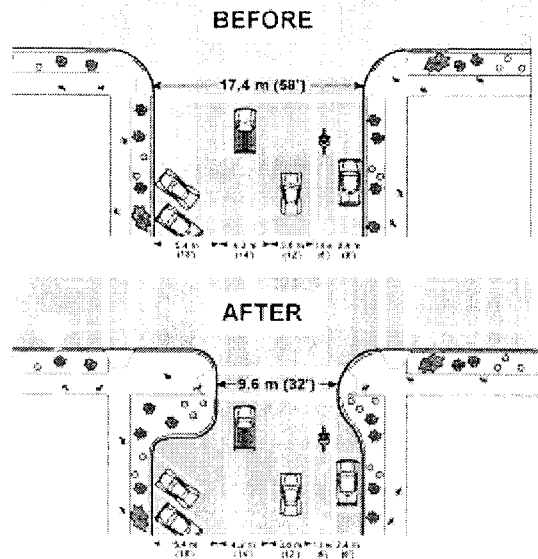

Figure X: Curb extensions reduce crossing distance

Also known as "bulbs, neckdowns, flares or chokers," curb extensions reduce the pedestrian crossing distance and improve the visibility of pedestrians by motorists. Curb extensions should be considered at all intersections where on-street parking is allowed. The crossing distance savings are greatest when used on streets with diagonal parking. On arterials and collectors, space should be provided for existing or planned bike lanes.

Reducing pedestrian crossing distance improves signal timing if the pedestrian phase controls the signal. The speed normally used for calculating pedestrian crossing time is 1.2 m (4 ft)/sec., or less where many older pedestrians are expected. The time saved is substantial when two corners can be treated with curb extensions.

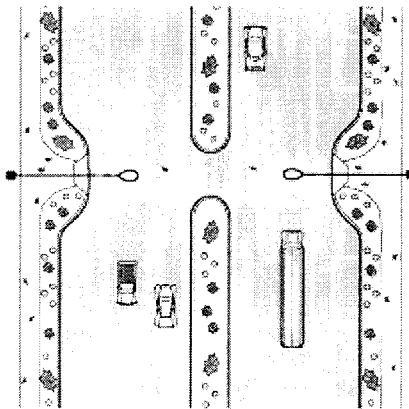

Figure X: Mid-block curb extension with median and illumination

Non-signalized intersections also benefit from curb extensions: reducing the time pedestrians are in a crosswalk improves pedestrian safety and vehicle movement.

Mid-block crossing curb extensions should be considered where there are current or anticipated pedestrian generating land uses on both sides of the road (see section A.1.b. Land Use).

A.2.c. Illumination

Providing illumination or improving existing lighting can increase nighttime safety at many locations, especially at mid-block crossings, which are often not expected by motorists.

A.2.d. Crosswalks

Marked crosswalks are generally located at all open legs of signalized intersections. They may also be considered at other locations. Combined with curb extensions, illumination and signage, marked crosswalks can improve the visibility of pedestrian crossings. Crosswalks send the message to motorists that they are encroaching on a pedestrian area, rather than the reverse, which is often the common assumption.

If a crosswalk is not working, some possible problems include:

Enforcement — more rigorous enforcement of traffic laws is needed for motorists to understand that it is their duty to yield to pedestrians in a crosswalk, marked or unmarked;

Location — marked crosswalks must be placed in locations where they are visible and where obstructions such as parked cars and signs do not affect sight lines;

Traffic movement — many turning vehicles at nearby intersections or driveways can compromise the crosswalk;

Users — Some people need extra help crossing a street and crosswalks alone may not be sufficient; for example, young children lack judgement and may need the positive control given by signals.

The above factors (combined with a traffic study if possible) should be considered to determine if a marked crosswalk will enhance pedestrian safety for a particular area. This is usually in locations that are likely to receive high use, based on proposed adjacent land use.

Crosswalks should be 3 m (10 ft) wide, or the width of the approaching sidewalk if it is greater. Two techniques to increase the visibility and effectiveness of crosswalks are:

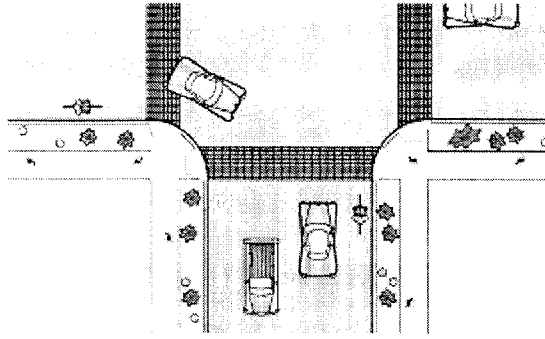

Figure X: Colored and textured crosswalk

- Striped (or "zebra") markings, which are more visible than double lines;
- Textured crossings, using non-slip bricks or pavers, which raise a driver's awareness through increased noise and vibration. Colored pavers increase the visibility of the crosswalk.

A.2.e. Islands and Refuges

At wide intersections, such as those connecting US20/OR34, there is a triangular area between a through lane and a turn lane unused by motor vehicle traffic. Placing a raised island in this area benefits pedestrians by:

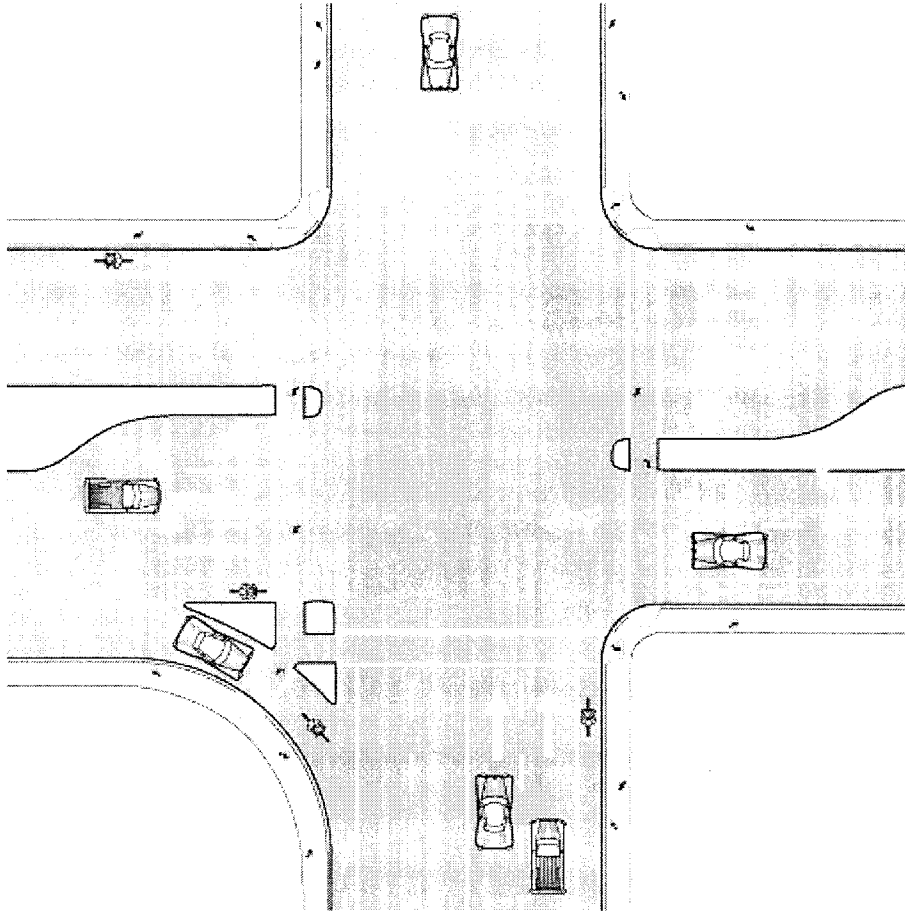

Figure X: Raised islands at intersections

- Allowing pedestrians to cross fewer lanes at a time, and to judge conflicts separately;
- Providing a refuge so that slower pedestrians can wait for a break in the traffic stream;
- Reducing the total crossing distance (which provides signal timing benefits); and
- Providing an opportunity to place easily accessible pedestrian push-buttons.

An island can also be provided in the middle of an intersection. An island must be a minimum of 1.2 m (4 ft) wide, preferably 2.4 m (8 ft) or more.

Islands must be large enough to provide refuge for several pedestrians waiting at once. For wheelchair accessibility, it is preferable to provide at-grade cuts rather than ramps. Poles must be mounted away from curb cuts and out of the pedestrian path.

A.2.f. Pedestrian Signals

A pedestrian activated signal may be warranted where the expected number of people needing to cross a roadway at a particular location is significant. Anticipated use must be high enough for motorists to get used to stopping frequently for a red light (a light that is rarely activated may be ignored when in use). Refer to the Manual on Uniform Traffic

Control Devices, approved by the Federal Highway Administration for pedestrian signal warrants.

Sight-distance must be adequate to ensure that motorists will see the light in time to stop. Warning signs should be installed on the approaching roadway.

Pedestrian signals may be combined with curb extensions, raised medians and refuges.

A.2.g. Signing

Recommended signs include both advance warning signs and pedestrian crossing signs at the crossing itself, and regulatory signs at intersections to reinforce the message that motorists must yield to pedestrians. These signs should only be placed at warranted locations, because excessive signage leads to signs being missed or ignored.

B. OTHER INNOVATIVE DESIGNS

These concepts are presented as information, to help the city to develop effective solutions to existing and future street-crossing problems.

B.1. Raised Crosswalks

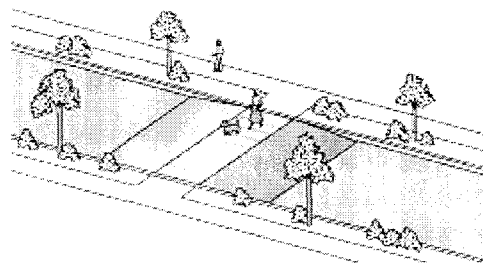

Figure X: Raised crosswalk acts as hump on local street

Raised crosswalks, especially if textured and colored, are more visible. They also act as speed humps and may be used in areas where excessive speeds are a problem. (See page 160 of the Oregon Bicycle and Pedestrian Plan for a discussion on the design and applicability of speed humps.)

D.2. Raised Intersections

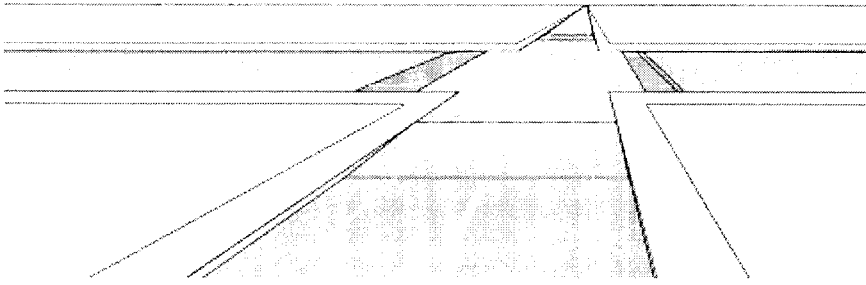

Figure X: Raised intersection

Raised intersections take this concept further: motorists see that the area is not designed for rapid through movement - it is an area where pedestrians are to be expected. The driver must be cautious in approaching the intersection and be ready to yield the right-of-way to pedestrians.

Raised crosswalks and intersections have additional advantages:

- It is easier to meet certain ADA requirements, as the crosswalk is a natural extension of the sidewalk, with no change in grade, but they require special treatment to be detected by the visually-impaired;
- Raised intersections can simplify drainage inlet placement, as all surface water will drain away from the intersection.

These methods should be considered along with other methods in any future couplet design to control traffic speed and create safe and effective pedestrian conditions.

APPENDIX G
GRAND AND LOAN CONTACTS 1998

APPENDIX G
GRANT AND LOAN CONTACTS-1998

	Contact Person	Phone Number
Bike-Pedestrian Grants	Michael Ronkin	(503) 986-3555
TEA-21 Enhancement program	Pat Rogers	(503) 986-3528
Highway Bridge Rehabilitation or Replacement Program (HBRR)	Mark Hirota	(503) 986-3344
Transportation Safety Grant Program	Troy Costales	(503) 986-4192
Special Transportation Fund	Gary Whitney	(503) 986-3885
Special Small city Allotment Program	Michael Augden	(503) 986-3893
Immediate Opportunity Grant Program	Mark Ford	(503) 986-3463
Oregon Special Public Works Fund	Betty Pongracz	(503) 986-0136
Oregon Transportation Infrastructure Bank	John Fink	(503) 986-3922